

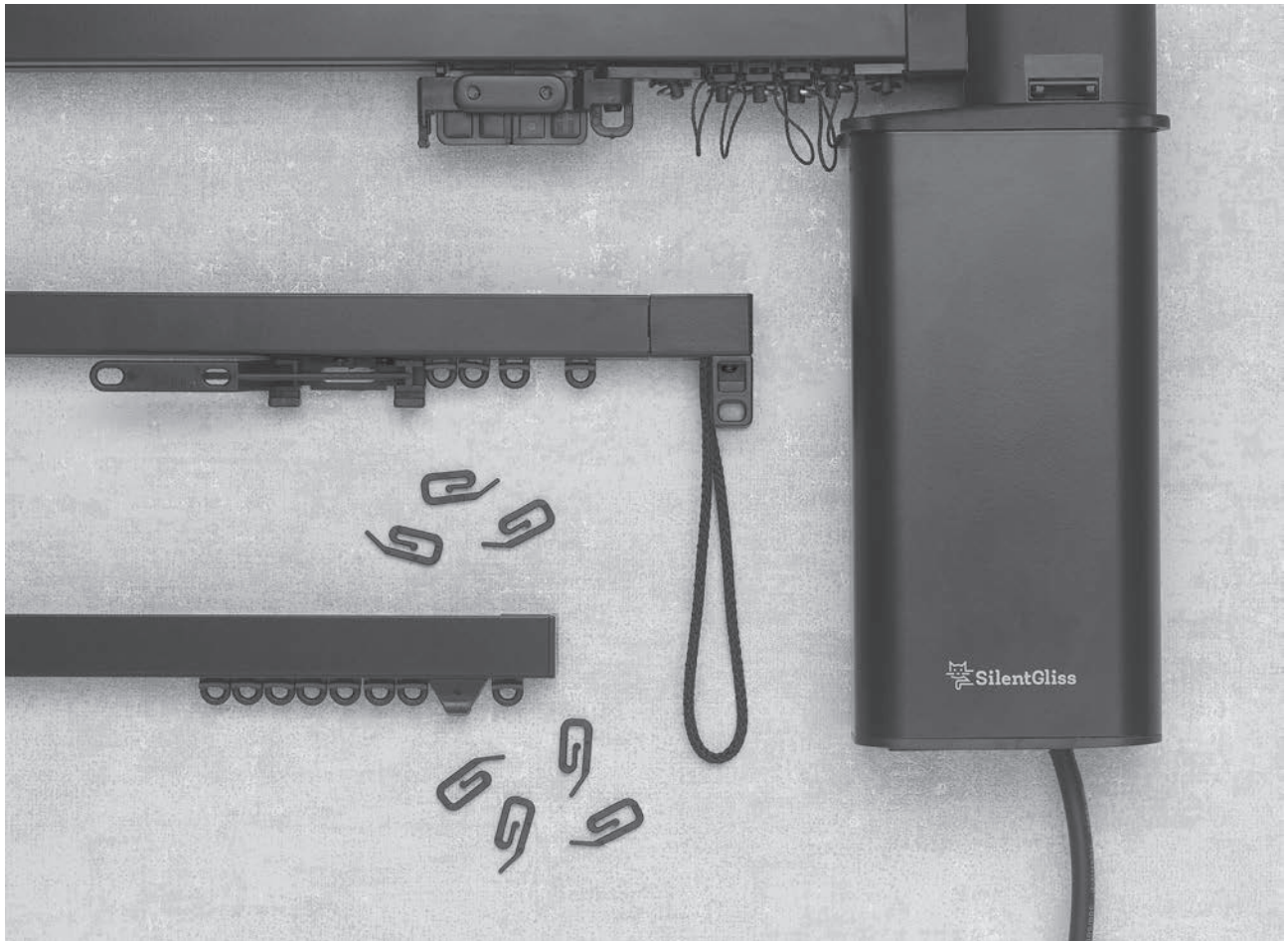

# PRICE LIST

RECOMMENDED RETAIL PRICES  
EXCLUDING VAT  
JANUARY 2025

 **SilentGliss**



This price list is intended to give comprehensive price information on all systems and on all components used with them. Its format follows that of the main Silent Gliss catalogue. Accessories usable with any given system should appear underneath that system.

## Index



### Hand Operated Curtain Track Systems

SG 1020, SG 1021, SG 1025, SG 1070, SG 1080, SG 1090, SG 1280, SG 6010, SG 6290, SG 6021, SG 6243, SG 6293, SG 6380, SG 6465, SG 6820, SG 6840, SG 6870, SG 6970

Pages: 2-9



### Cord Operated Curtain Track Systems

SG 3000, SG 3840, SG 3870, SG 3900, SG 3970, SG 6370

Pages: 10-13



### Metropole

SG 7600, SG 7610, SG 7620, SG 7630, SG 7640, SG 7650, SG 7605

Pages: 14-22



### Room divider / Cubicle Track Systems

SG 6100, SG 6103, SG 6650

Pages: 23-24



### Electric Curtain Track Systems

SG 5100B, SG 5100R, SG 5100T, SG 5100TC, SG 5600, SG 5800

Pages: 25-27



### Switches and Controls

SG 0450, SG 9940, Battery Operated Controls, SMART.

Page: 28



### Roman Blind Systems

SG 2120, SG 2305, SG 2345, SG 2350, Made-to-measure Roman Blinds

Pages: 29-31



### Panel Glide Systems

SG 2700, SG 2730

Page: 32



### Skylight Shading Systems

SG 2190, SG 2195, SG 8600, SG 8640

Page: 33-35



### Vertical Blind Systems

SG 2810, SG 2900, SG 2950

Pages: 36-42



### Roller Blind Systems

SG 4900, SG 4907, SG 4910, SG 4930, SG 4840, SG 4955, SG 4960, SG 4970, SG 4880, Application chart, Fascia pricing tables

Pages: 43-57



### Dim-Out Blind Systems

SG 4710, SG 4730, SG 4740, SG 4760, SG 4770, SG 4780

Pages: 58-61



### Venetian Blind Systems

SG 8110 (16mm), SG 8110PC (25mm), SG 8250, SG 8300, SG 8910, SG 8960

Pages: 62-71



### Pleated Blind Systems

SG 8500

Pages: 72



### Digital Printing/Special Colours (profile/components)

Page: 73



### Wave

Page: 74



### Swiss Pleat Curtains

Page: 75



### Parts Index/Tools & Packaging/Application Chart for switches, remote control and multiple operation of motorised systems/Conditions of Sale

Pages: 77-97

## Prices

Prices are maximum recommended Retail Price, not including VAT. Trade discounts applicable vary with product group as detailed below. Each system and item is designated as belonging to one of the following groups:-

**Product Group A** 1020, 1021, 1025, 1070, 1080, 1090, 1280, 2120, 2305, 3000, 3600, 3840, 3870, 3900, 5100B, 5100R, 5100T, 5100TC, 6010, 6021, 6100, 7600, 7605, 7610, 7620, 7630, 7640, 7650\*, 6290, 6243, 6293, 6380, 6465, 6650, 6820, 6840, 6870, 6970 made to measure Roman blinds.

**Product Group C** 0450, 2190, 2195, 2345, 2350, 2700, 2730, 2810, 2900, 2950, 3970, 4710, 4730, 4740, 4760, 4770, 4780, 4930, 4840, 4970, 4880, 4900, 4907, 4910, 4955, 4960, 5600, 5800, 6370, 7650\*, 8110, 8250, 8300, 8500, 8600, 8640, 8910, 8960, 9940, SMART.

Silent Gliss Fabrics, Laminated blinds.

**Product Group E** Tools, Promotional material.

\*5100 Version, Product Group A.

\*5600 Version, Product Group C.





# Hand Operated Curtain Track Systems

## SG 1020

Supplied in white. Profile available in 6 metre lengths. Top fix as standard.

27cm std.

## SG 1021

## SG 1025

Supplied in satin silver or white. For special colours see below – special order.

Silver profile available in 6 metre lengths, white in 6 metre lengths only.

10cm std.

System Prices		Price Ctg.
Specific lengths charged at the nearest 25cm increment above.		<b>A</b>
cm	White £	
125	55.31	
150	59.79	
175	68.17	
200	72.67	
225	81.02	
250	85.50	
275	93.88	
300	98.38	
325	106.73	
350	111.21	
375	119.60	
400	124.08	
425	132.47	
450	136.92	
475	145.31	
500	149.79	
525	158.16	
550	162.64	
575	171.03	
600	175.51	
Prices above are for systems ready-assembled. Substantial savings can be made for self-assembly. Rail can be supplied in full lengths or cut-to-size with accessories separately.		

Rail and Standard Accessories		Price Ctg.
6822 Rail, white in 6m.		<b>A</b>
6824 Endcover white, each, 10, 100.		
3016 Endstop, each, 100.		
3533 Glider Box, 100.		
Self-service sachets, 25 x 25, Euroslat sachet 25		
3534 Glider, in strip form, at 14 per m, outer 1000.		
11236 Clip, 100.		

Optional Accessories		Price Ctg.
(additional charges may apply)		<b>A</b>
3062 Connecting bridge.		
3070 Twist eye endstop, each, 10.		
3071 Screw twist endstop, each, 10.		
3511 Glider, 100, outer, 25,000.		
3548 Retrofit glider, 25, 100, 1000.		
3570 Rotating glider, 10, 100.		
3582 Hook, Box, 100. Self service sachets, 25x25. Outer, 1,000.		
Outer, 20,000.		
3599 Hook, box 100, outer 25,000.		
10430-10434 Draw Rods, white, black or aluminium.		
11335 Endstop white, silver or black, each, 100.		
Colours		<b>E</b>
Other colours special order - see Page 73.		
Bending		<b>33 1/3%</b>
	Max. trade discount	
Angle bend £38.50 each.		
Standard radius 27cm.		
Semi-circle or gradual curve £49.50 each.		

Rail and Standard Accessories		Price Ctg.
1021p/1025p Rail, silver available in 6m or cut-to-size.		<b>A</b>
White available in 6m or cut-to-size.		
3533 Glider at 14 per metre. Box, 100. Self-service sachets, 25 x 25. Outer, 25,000.		
3534 Glider, in strip form, at 14 per metre. Outer, 1,000 gliders.		
6835A Screw, 12mm/1/2" No. 4 round head at 300mm centres, 100.		
3016 Endstop, each, 100.		

System Prices			Price Ctg.
Specific lengths charged at the nearest 25cm increment above.			<b>A</b>
cm	Silver £	White £	
125	19.61	31.96	
150	23.58	38.39	
175	27.47	44.75	
200	31.37	51.09	
225	35.33	57.49	
250	39.26	63.82	
275	43.15	70.22	
300	47.11	76.65	
325	51.06	83.05	
350	54.94	89.40	
375	58.82	95.83	
400	62.82	102.20	
425	66.75	108.55	
450	70.63	114.90	
475	74.59	121.44	
500	78.49	127.74	
525	82.43	134.12	
550	86.41	140.50	
575	90.25	146.93	
600	94.19	153.28	
Above prices are for systems ready-assembled. Substantial savings can be made for self-assembly. Rail can be supplied in full lengths or cut-to-size with accessories separately.			

Optional Accessories		Price Ctg.
(additional charges may apply)		<b>A</b>
3511 Glider, at 16 per metre, 100. Outer, 25,000 gliders.		
3532 Glider. 100. Outer, 5,000.		
3570 Rotating glider, 100.		
3582 Hook, Box, 100. Self-service sachets, 25 x 25. Outer, 1,000. Outer, 20,000.		
3020 Hook. Metal, 100.		
3599 Hook. Box, 100. Self-service sachets, 25 x 25. Outer, 25,000.		
3032 Spring stop, 10, 100.		
3070 Twist eye endstop, each, 10.		
3071 Screw twist endstop, each, 10.		
3562 Standard tape, 100 metres.		
3580 Side mounted glider/hook, 100. Outer, 5,000.		
3571 Hook. Box, 100. Self-service sachets, 25 x 25. Outer, 35,000.		
6835B Screw 24mm/1", 100.		
3548 Retrofit glider, 25, 100, 1000.		
3068A Loop tape, 250 metres.		
10430 - 10434 Draw rods, white, black or aluminium		
Colours		<b>E</b>
Other colours special order - see Page 73.		
Tools		<b>E</b>
80018 Slotting tool		
7809 Filler set at 200cm		
Bending		<b>33 1/3%</b>
	Max. trade discount	
Angle bend £38.50 each.		
Standard radius 10cm.		

All prices shown exclude VAT





# Hand Operated Curtain Track Systems

## SG 1070

Supplied in white. Profile available in 6 metre lengths. Top fix as standard.

12cm std.

## SG 1080

Supplied in satin silver anodised finish, white, black, matt white, antique bronze, anodic grey and charcoal. Silver and white profile available in 5 and 6 metre lengths, other coloured profiles 6m only.

10cm std.

System Prices		Price Ctg.
Specific lengths charged at the nearest 25cm increment above.		<b>A</b>
cm	White £	
125	26.83	
150	30.87	
175	35.89	
200	39.92	
225	44.94	
250	48.98	
275	54.00	
300	58.02	
325	63.04	
350	67.07	
375	72.10	
400	76.13	
425	81.14	
450	85.15	
475	90.21	
500	94.23	
525	99.24	
550	103.28	
575	108.31	
600	112.32	
Prices above are for systems ready-assembled. Substantial savings can be made for self-assembly. Rail can be supplied in full lengths or cut-to-size with accessories separately.		

Rail and Standard Accessories		Price Ctg.
1071 Rail, white in 6m Lengths.		<b>A</b>
1072 Endcover white, 10, 100.		
3016 Endstop, each, 100.		
3060 Clamp, each, 10, 100.		
3533 Glider Box, 100.		
Self-service sachets, 25 x 25, Eurostat sachet 25.		
3534 Glider, in strip form, at 14 per m, outer 1000.		

All prices shown exclude VAT

Optional Accessories		Price Ctg.
(additional charges may apply)		<b>A</b>
3070 Twist eye endstop, each, 10.		
3062 Connecting bridge, each.		
3511 Glider, 100, outer, 25,000.		
3548 Retrofit glider, 25, 100, 1000.		
3570 Rotating glider, 10, 100.		
3582 Hook, box 100, outer 1,000, outer 20,000.		
3599 Hook, box 100, outer 25,000.		
10430-10434 Draw Rods, white, black or aluminium.		
11335 Endstop white, silver or black, each, 100.		
<b>Colours</b>		<b>E</b>
Other colours special order - see Page 73.		

Bending		Max. trade discount	33 1/3%
Angle bend £38.50 each.			
Standard radius 12cm.			
Semi-circle or gradual curve £49.50 each.			

System Prices			Price Ctg.
Specific lengths charged at the nearest 25cm increment above.			<b>A</b>
cm	W/S/BL	MW/AB/AG/CC	
	£	£	
125*	29.05	48.56	
150*	34.80	57.45	
175*	40.59	66.41	
200*	46.38	75.38	
225*	52.19	84.28	
250*	57.95	93.28	
275*	63.80	102.08	
300	69.63	111.02	
325	75.37	120.03	
350	81.24	128.90	
375	86.97	137.88	
400	92.74	146.76	
425	98.57	155.65	
450	104.39	164.67	
475	110.14	173.58	
500	115.97	182.45	
525	121.73	191.40	
550	127.54	200.38	
575	133.34	209.23	
600	139.10	218.24	
Above prices are for systems ready-assembled. Substantial savings can be made for self-assembly. Rail can be supplied in full lengths or cut-to-size with accessories separately.			
<b>*1080W Packed in Acetate:</b>			
For sizes marked with an asterisk above we offer our 1080 in white only in clear acetate self-service display packaging. Prices are the same as indicated above.			
Min. order 12 lengths.			

1128R Screw 37mm/1 1/2", No. 8 round head, 100.

3089 Glider hook, 20.

6146 Nylon hook, 12.

3660 Extra long universal bracket.

3655 Long universal bracket.

3562 Standard tape, 100 metres.

3582 Curtain hooks, white, black.

3620 Connecting bridge, each, 10.

3602 Nylon wall support, white, each, 10.

3606 Snap fastener each, 10.

3618 Metal wall support, each, 10.

3626 Return fixing bracket, each.

3639 Hanger rod assembly, 2' system complete.

Smart Fix Brackets in W/S/BL/MW/AG/AB/CC		Price Ctg.
11118 Smart Fix 60mm Bracket (11200 Set).		<b>A</b>
11119 Smart Fix 80mm Bracket (11201 Set).		
11120 Smart Fix 100mm Bracket (11202 Set).		
11121 Smart Fix 120mm Bracket (11203 Set).		
11122 Smart Fix 150mm Bracket (11204 Set).		
11123 Smart Fix 200mm Bracket (11205 Set).		
<b>Square Smart Fix Brackets in W/S/BL/MW/AG/AB/CC</b>		
11139 Smart Fix 60mm Bracket (11210 Set).		
11140 Smart Fix 80mm Bracket (11211 Set).		
11141 Smart Fix 100mm Bracket (11212 Set).		
11142 Smart Fix 120mm Bracket (11213 Set).		
11143 Smart Fix 150mm Bracket (11214 Set).		
11144 Smart Fix 200mm Bracket (11215 Set).		
<b>Smart Fix Bracket Covers</b>		
11116 Smart Fix Bracket Cover.		
11137 Square Smart Fix Bracket Cover		
<b>Universal Smart Fix Extension Bracket</b>		
11154 Universal Smart Fix 120mm.		
11155 Universal Smart Fix 150mm.		
11156 Universal Smart Fix 200mm.		
3151 Clearance spacer (for top boards).		<b>E</b>

Rail and Standard Accessories		Price Ctg.
1080p Rail, silver, white, in 5m & 6m, matt white, antique bronze, anodic grey, black and charcoal in 6m.		<b>A</b>
3533 Glider Box, white, black 100.		
Self-service sachets, 25 x 25.		
Outer, 25,000. Eurostat sachet 25.		
3534 Glider, white, black in strip form, at 14/m.		
18R Screw 25mm/1". No. 8 round head, 100.		
3667 Endcover/stop, grey, white, black, matt white, anodic grey, antique bronze, charcoal, each 10, 100.		
Eurostat sachet 2 (white and grey only).		
3630 Universal nylon bracket, white, black at 600mm centres, each 10, 100. Eurostat sachet 2.		
<b>Optional Accessories</b>		<b>A</b>
(additional charges may apply)		
3016 Endstop, each, 100.		
3511 Glider, at 16 per metre, 100. Outer, 25,000 gliders.		
3570 Rotating glider, 100.		
3020 Hook. Metal, 100.		
3638 Reinforced corner piece for pelmets, each, 10.		
3603 Top fix brackets, white, black each, 10, 100.		
3548 Retrofit glider, 25, 100, 1000.		
3630 Universal bracket, brown gold, each, 10.		
3571/3582/3599 Hooks - see under 1021/5.		
3070 Twist eye endstop, white, black each, 10.		

Tools, etc		Price Ctg.
80018 Slotting tool.		<b>E</b>
7103 Portable hand operated bending tool.		
7109 Portable electrically operated bending tool.		
7806 Filler set for 1080 at 200cm for 7103/9.		
0540 Bending tool for gradual curves.		
<b>Bending</b>		<b>33 1/3%</b>
Max. trade discount		
Angle bend £38.50 each.		
Standard radius 10cm.		
Semi-circle or gradual curve £49.50 each.		
Arch £92.50 each. Standard radius 30cm.		
<b>3600 Picture Hanging System</b>		<b>A</b>
Use prices for 1080 rail only and 3606 supports, covers 3667 where necessary plus special components below.		
3637A Cord ø 1.5mm nom.		
3600 Picture hanging system complete (including 4x3663, cord 3637A & 3634 delrin height adjuster)		
3657 Connecting bridge for picture hanging system.		
3605 Endcover.		



# Hand Operated Curtain Track Systems

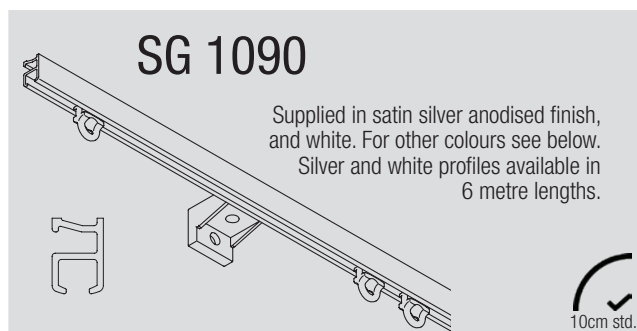

## SG 1090

Supplied in satin silver anodised finish, and white. For other colours see below. Silver and white profiles available in 6 metre lengths.

10cm std.

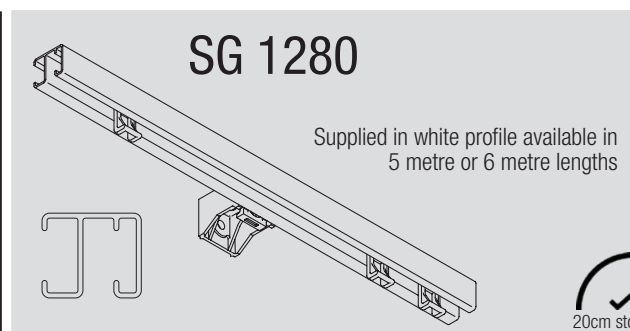

## SG 1280

Supplied in white profile available in 5 metre or 6 metre lengths

20cm std.

System Prices		Price Ctg.
Specific lengths charged at the nearest 25cm increment above.		A
cm	W/S £	
125	26.82	
150	32.22	
175	37.55	
200	42.96	
225	48.30	
250	53.62	
275	58.98	
300	64.36	
325	69.80	
350	75.19	
375	80.46	
400	85.85	
425	91.17	
450	96.58	
475	101.89	
500	107.33	
525	112.67	
550	118.00	
575	123.41	
600	128.71	
Above prices are for systems ready-assembled. Substantial savings can be made for self-assembly. Rail can be supplied in full lengths or cut-to-size with accessories separately.		

Rail and Standard Accessories		Price Ctg.
1090p Rail, silver and white in 6m or cut-to-size.		A
3533 Glider. Box, 100. Self-service sachets, 25 x 25. Outer, 25,000. Euroslot sachet 25. 3534 Glider, in strip form, at 14 per metre. Outer, 1,000 gliders.		
3016 Endstop, each, 100.		
3175 Universal Nylon Bracket, white, 10, 100.		

Optional Accessories		Price Ctg.
(additional charges may apply)		A
18R Screw, 25mm/1", No. 8 round head, 100.		
3511 Glider, at 16 per metre, 100. Outer, 25,000 gliders.		
3570 Rotating glider, 100.		
3582 Hook, 100. Self-service sachets, 25 x 25.		
Outer, 1,000. Outer, 20,000.		
3020 Hook, Metal, 100.		
3599 Hook. Box, 100. Self-service sachets, 25 x 25. Outer, 25,000.		
3176 Top fix bracket, white, 10, 100.		
3070 Twist eye endstop, each, 10.		
1128R Screw 37mm/1½", No. 8 round head, 100.		
3548 Retrofit glider, 25, 100, 1000.		
3562 Standard tape, 100 metres.		
3096 Connecting bridge, each, 10.		
3113 5cm metal spacer, 10, 100.		
3115 7cm metal spacer, 10, 100.		
10430 - 10434 Draw rods, white, black or aluminium		
Smart Fix Brackets in white, black or silver		
11118 Smart Fix 60mm Bracket (11200 Set).		
11119 Smart Fix 80mm Bracket (11201 Set).		
11120 Smart Fix 100mm Bracket (11202 Set).		
11121 Smart Fix 120mm Bracket (11203 Set).		
11122 Smart Fix 150mm Bracket (11204 Set).		
11123 Smart Fix 200mm Bracket (11205 Set).		
Square Smart Fix Brackets in white, black or silver		
11139 Smart Fix 60mm Bracket (11210 Set).		
11140 Smart Fix 80mm Bracket (11211 Set).		
11141 Smart Fix 100mm Bracket (11212 Set).		
11142 Smart Fix 120mm Bracket (11213 Set).		
11143 Smart Fix 150mm Bracket (11214 Set).		
11144 Smart Fix 200mm Bracket (11215 Set).		
Smart Fix Bracket Covers		
11116 Smart Fix Bracket Cover.		
11137 Square Smart Fix Bracket Cover.		
Colours		E
Other colours special order – see page 73.		
Tools		E
Sleeving SL1090, SL1090W per reel.		
80018 Slotting tool.		
7809 Filler set at 200cm, 2 required		
Bending		33⅓%
Max. trade discount		
Angle bend £38.50 each. Standard radius 10cm.		
Semi-circle or gradual curve £49.50 each.		

System Prices		Price Ctg.
Specific lengths charged at the nearest 25cm increment above.		A
cm	White £	
125	44.15	
150	53.06	
175	61.77	
200	70.62	
225	79.43	
250	88.25	
275	97.11	
300	105.89	
325	114.76	
350	123.56	
375	132.40	
400	141.23	
425	149.98	
450	158.88	
475	167.74	
500	176.49	
525	185.32	
550	194.19	
575	203.02	
600	211.82	
Above prices are for systems ready-assembled. Substantial savings can be made for self-assembly. Rail can be supplied in full lengths or cut-to-size with accessories separately.		

Rail and Standard Accessories		Price Ctg.
1280p White rail, available in 5m or 6m lengths, in outsiders of 10 lengths only.		A
3630 Universal nylon bracket, white, at 600mm centres, 100.		
3922 Roller glider in strip form at 10 per metre, outer of 1,000 gliders, outer of 6,000 gliders.		
3985 Eyelet endcover/endstop in white, 100.		
18R Screw 25mm/1", No. 8 round head, 100.		

Optional Accessories		Price Ctg.
(additional charges may apply)		A
3620 Connecting bridge.		
3975 Overlap for pulling by hand, each, 10.		
3935A Combination overlap straight, complete with 'S' hook attachment 3949, each, 10.		
3936A Combination overlap complete with 'S' hook attachment 3949, each, 10.		
3947 Pair of magnetic gliders, 10.		
3942 Intermediate stop, 10.		
3603 Top fix bracket, white each, 10, 100.		
3582 Hook, box 100, outer 1,000, outer 20,000.		
3599 Hook, box 100, outer 25,000.		
3562 Standard tape, 100m.		
10430 - 10434 Draw rods, white, black or aluminium		
Smart Fix Brackets in white, black or silver		
11118 Smart Fix 60mm Bracket (11200 Set).		
11119 Smart Fix 80mm Bracket (11201 Set).		
11120 Smart Fix 100mm Bracket (11202 Set).		
11121 Smart Fix 120mm Bracket (11203 Set).		
11122 Smart Fix 150mm Bracket (11204 Set).		
11123 Smart Fix 200mm Bracket (11205 Set).		
Square Smart Fix Brackets in white, black or silver		
11139 Smart Fix 60mm Bracket (11210 Set).		
11140 Smart Fix 80mm Bracket (11211 Set).		
11141 Smart Fix 100mm Bracket (11212 Set).		
11142 Smart Fix 120mm Bracket (11213 Set).		
11143 Smart Fix 150mm Bracket (11214 Set).		
11144 Smart Fix 200mm Bracket (11215 Set).		
Smart Fix Bracket Covers		
11116 Smart Fix Bracket Cover.		
11137 Square Smart Fix Bracket Cover.		
Universal Smart Fix Extension Bracket		
11154 Universal Smart Fix 120mm.		
11155 Universal Smart Fix 150mm.		
11156 Universal Smart Fix 200mm.		
3151 Clearance spacer (for top boards).		E
Colours		E
Other Colours Special Order – Consult Silent Gliss for pricing.		
Tools		E
7103 Portable hand operated bending tool.		
7109 Portable electrically operated bending tool.		
80018 Slotting tool.		
7844 Filler set for 7103/7109, 70cm.		
7844A Filler set for 0540, 200cm.		
0540 Bending tool for gradual curves		
Bending		33⅓%
Max. trade discount		
Angle bend £38.50 each. Standard radius 20cm.		
Semi-circle or gradual curve £49.50 each.		

All prices shown exclude VAT



# Hand Operated Curtain Track Systems

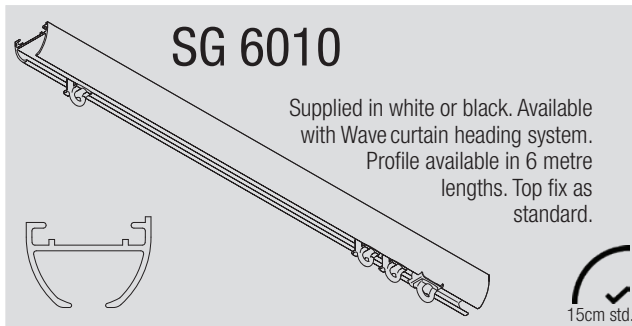

## SG 6010

Supplied in white or black. Available with Wave curtain heading system. Profile available in 6 metre lengths. Top fix as standard.

15cm std.

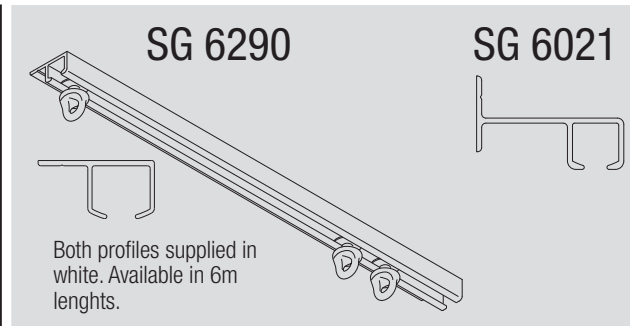

## SG 6290

## SG 6021

Both profiles supplied in white. Available in 6m lengths.

	Price Ctg.
--	------------

### System Prices

Specific lengths charged at the nearest 25cm increment above.

cm	W/BL Standard Glider	W/BL 60mm Wave	W/BL 80mm Wave
	£	£	£
125	56.76	82.35	74.58
150	64.50	95.43	86.11
175	75.67	111.56	100.69
200	83.40	124.64	112.22
225	94.57	140.77	126.80
250	102.31	153.86	138.33
275	113.48	169.99	152.91
300	121.22	183.08	164.44
325	132.38	199.21	179.02
350	140.12	212.29	190.55
375	151.29	228.42	205.13
400	159.03	241.51	216.66
425	170.19	257.64	231.24
450	177.93	270.72	242.77
475	189.10	286.85	257.35
500	196.84	299.94	268.88
525	208.01	316.07	283.46
550	215.74	329.16	294.99
575	226.91	345.29	309.57
600	234.66	358.39	321.11

Above prices are for systems ready-assembled. Substantial savings can be made for self-assembly. Rail can be supplied in full lengths or cut-to-size with accessories separately.

### Enhanced Wave Options

Add the following to the systems prices above:

- Option 1**  
2256 Adjustable Brake  
Single-stack £9.66; Pair-stack £19.31
- Option 2**  
2255 Adjustable Brake & 6366 Carrier  
Single-stack £19.62; Pair-stack £39.22
- Option 3**  
Enhanced Wave (80mm only)  
Single-stack £36.40; Pair-stack £72.83

### Rail and Standard Accessories

6010p Rail, white, black available in 6 metre lengths.

3825 Clamp.

6018 Endcover, white, black.

6065 Twist eye end stop, white, black 10, 100.

#### Standard Gliders

11301 2C Gliders in strip form, white, black at 14 per m, outer 1000.

#### Wave Gliders

11302 Wave 2C Glider-cord 80mm, white, black.

11303 Wave 2C Glider-cord 60mm white, black.

All prices shown exclude VAT

	Price Ctg.
--	------------

### Optional Accessories

(additional charges may apply)

- 2255 Adjustable brake, white, black.
- 2256 Adjustable brake, white, black.
- 3020 Hook, Metal, 100.
- 3571 Hook, Box, 100.
- Self-service sachets, 25 x 25. Outer, 35,000.
- 3582 Curtain hooks, white, black.
- 3599 Hook, box, white, black 100. Self-service sachets, 25 x 25. Outer, 25,000.
- 3802 Connecting bridge.
- 3826 Nylon bracket, white, black (top fix).
- 3832 Clamp for top fixing.
- 6053 Spring Stop, 10.
- 6064 Endstop.
- 6283 Roller-glider.
- 6349 Wave®curtain tape, white, black.
- 6364 Extension, white, black.
- 6365 Hanger, white, black.
- 6363 Iron-on hemming tape.
- 6366 Draw rod carrier, white, black.
- 10075 Lead curtain weight.
- 10076 Fabric side weight.
- 10430-10434 Draw rods, white, black or aluminium.
- 11295 Endstop, Silver, White, Black each 10.
- 1148C Screw.

### Colours

Other colours special order – See page 73.

### Tools

- 7103 Portable hand operated bending tool.
- 7109 Portable electrically operated bending tool.
- 7885 Filler set 6010 at 200cm for 7103/7109.
- 7439 Blocks for 7103/7109, 2 required.
- 7404 Former for 7103/7109, radius 15cm.

### Bending

Max. trade discount 33 1/3%  
Angle bend £60.50 each.  
Standard radius 15 cm.  
Semi-circle or gradual curve £81.50 each.

	Price Ctg.
--	------------

### System Prices

Specific lengths charged at the nearest 25cm increment above.

cm	6290 White	
	£	
125	26.36	
150	31.65	
175	36.85	
200	42.12	
225	47.43	
250	52.61	
275	57.94	
300	63.18	
325	68.50	
350	73.72	
375	79.03	
400	84.26	
425	89.55	
450	94.81	
475	100.09	
500	105.34	
525	110.60	
550	115.89	
575	121.16	
600	126.41	

### System Prices

Specific lengths charged at the nearest 25cm increment above.

cm	6021 White	
	£	
125	33.81	
150	40.58	
175	47.32	
200	54.05	
225	60.84	
250	67.58	
275	74.35	
300	81.07	
325	87.87	
350	94.67	
375	101.41	
400	108.15	
425	114.89	
450	121.66	
475	128.42	
500	135.19	
525	141.94	
550	148.67	
575	155.44	
600	162.25	

Above prices are for systems ready-assembled. Substantial savings can be made for self-assembly. Rail can be supplied in full lengths or cut-to-size with accessories separately.

	Price Ctg.
--	------------

### Rail and Standard Accessories

6290p White rail, available in 6m lengths.

6021p White rail available in 6m lengths.

6122 Endstop, 100.

6148 Glider at 10 per m, 1,000.

6149 Lead glider (blue) at 2 per length, 100.

### Optional Accessories

(Additional charges may apply)

3582 Hook, 100, 1,000, 20,000.

3599 Hook, 100, 25,000.

3562 Standard tape, 100m.

10430 - 10434 Draw rods, white, black or aluminium

### Colours

Other colours special order – See page 73.

### Bending

Straight only.





# Hand Operated Curtain Track Systems

## SG 6243

Supplied in white profile. Available in 6m lengths. Recess Profile.

25cm std.

## SG 6293

Supplied in white. Profile. available in 6 metre lengths. Top fix as standard.

System Prices				Price Ctg.
Specific lengths charged at the nearest 25cm increment above.				A
cm	White Standard	White Wave Glider		
	£	60mm	80mm	
125	47.62	76.27	71.83	
150	53.62	88.02	82.68	
175	59.63	99.74	93.52	
200	65.63	111.49	104.36	
225	71.63	123.22	115.21	
250	77.63	134.95	126.05	
275	83.63	146.70	136.88	
300	89.63	158.42	147.73	
325	95.66	170.16	158.58	
350	101.65	181.90	169.43	
375	107.66	193.63	180.27	
400	113.62	205.36	191.11	
425	119.63	217.09	201.96	
450	125.62	228.83	212.80	
475	131.62	240.57	223.63	
500	137.65	252.29	234.49	
525	143.64	264.04	245.33	
550	149.63	275.76	256.18	
575	155.64	287.50	267.02	
600	161.64	299.24	277.87	

Prices above are for systems ready-assembled. Substantial savings can be made for self-assembly. Rail can be supplied in full lengths or cut-to-size with accessories separately.

Enhanced Wave Options		Price Ctg.
Add the following to the systems prices above:		A
<b>Option 1</b> 2256 Adjustable Brake Single-stack £9.66; Pair-stack £19.31		
<b>Option 2</b> 2255 Adjustable Brake & 6366 Carrier Single-stack £19.62; Pair-stack £39.22		
<b>Option 3</b> Enhanced Wave (80mm only) Single-stack £36.40; Pair-stack £72.83		

Rail and Standard Accessories		Price Ctg.
10717 Screw, 19mm, 100.		A
6053 Spring Stop, 10.		
6243p White rail available in 6m lengths only.		
6065 Twist eye end stop, 10, 100.		
7002 Rail protector.		
Plus one of the following options:		
Standard Gliders		
11301 2C Gliders in strip form, at 14 per m, outer 1000.		
Wave Gliders		
11302 Wave 2C Glider-cord 80mm.		
11303 Wave 2C Glider-cord 60mm.		

All prices shown exclude VAT

Optional Accessories		Price Ctg.
(additional charges may apply)		A
2255 Adjustable brake.		
2256 Adjustable brake.		
3020 Hook, Metal, 100.		
3067 Connecting bridge.		
3571 Hook. Box, 100. Self-service sachets, 25 x 25. Outer, 35,000.		
3582 Curtain hooks (each).		
3599 Hook. box, 100. Self-service sachets, 25 x 25. Outer, 25,000.		
6094 Roller glider with hook, 10, 100.		
6099 Roller glider-cord 80mm pitch. Outer of 50m.		
6283 Roller glider at 10 per metre. Outer 10, 100.		
6349 Wave®curtain tape.		
6364 Extension.		
6365 Hanger.		
6363 Iron-on hemming tape.		
6366 Draw rod carrier.		
10075 Lead curtain weight.		
10076 Fabric side weight.		
10430-10434 Draw rods, white, black or aluminium.		
11295 Endstop, White, Silver or Black each 10.		

Colours		Price Ctg.
To special order – see page 73.		E

Tools		Price Ctg.
7230 Slotting tool.		E

Bending		Max. trade discount
Angle bend £38.50 each.		33 1/3%
Standard radius 25cm.		
Gradual curve £49.50 each.		

System Prices			Price Ctg.
Specific lengths charged at the nearest 25cm increment above.			A
cm	White Standard	White *Std/Roller Glider	
	£	£	
125	76.78	101.62	
150	90.94	119.08	
175	105.10	139.33	
200	119.26	156.79	
225	133.42	177.04	
250	147.59	194.49	
275	161.75	214.74	
300	175.91	232.19	
325	190.07	252.45	
350	204.23	269.90	
375	218.40	290.15	
400	232.56	307.60	
425	246.72	327.86	
450	260.88	345.31	
475	275.04	365.56	
500	289.21	383.01	
525	303.37	403.27	
550	317.53	420.72	
575	331.69	440.97	
600	345.86	458.42	

Prices above are for systems ready-assembled. Substantial savings can be made for self-assembly. Rail can be supplied in full lengths or cut-to-size with accessories separately.

Rail and Standard Accessories		Price Ctg.
6065 Twist eye endstop, each, 10, 100.		A
6283 Roller glider at 10 per metre. Outer 10, 100.		
6293p Rail, white in 6m lengths.		
11301 2C Glider in strip form, at 14 per m, outer 1000.		

\*Standard 11301 gliders for voile and 6283 gliders for main curtains.

Optional Accessories		Price Ctg.
(additional charges may apply)		A
3599 Hook. Box, 100. Self-service.		
6053 Spring stop, 10.		
6094 Roller glider with hook, 10, 100.		
6098 Roller glider with eye.		
6269 Connecting bridge.		
10430-10434 Draw Rods, white, black or aluminium.		

Colours		Price Ctg.
Other colours special order - see Page 73.		E

Bending	
Straight only.	



# Hand Operated Curtain Track Systems

## SG 6380

Supplied in white. Profile available in 6 metre lengths. Universal fixing with 3630 bracket.

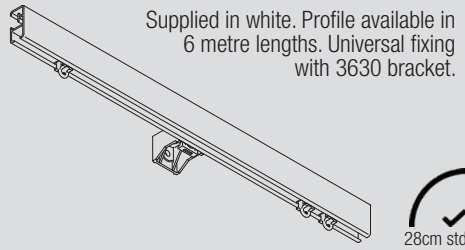

28cm std.

## SG 6465

Supplied in white or black. Available with Wave curtain heading system. Profile available in 6 metre lengths. Top fix as standard. Optional ccess profile available.

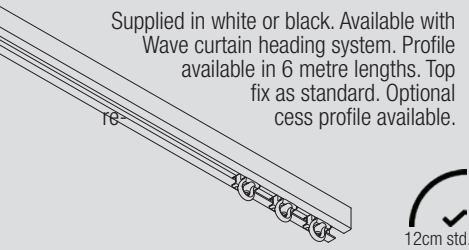
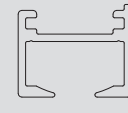

12cm std.

System Prices		Price Ctg.
Specific lengths charged at the nearest 25cm increment above.		A
White Standard Glider	White Roller Glider	
£	£	
125	60.68	85.14
150	68.73	96.87
175	79.08	112.92
200	87.12	124.64
225	97.47	140.69
250	105.52	152.42
275	115.87	168.47
300	123.92	180.20
325	134.27	196.25
350	142.32	207.98
375	152.67	224.03
400	160.72	235.76
425	171.06	251.81
450	179.11	263.54
475	189.46	279.58
500	197.51	291.31
525	207.86	307.36
550	215.91	319.09
575	226.26	335.14
600	234.33	346.87

Prices above are for systems ready-assembled. Substantial savings can be made for self-assembly. Rail can be supplied in full lengths or cut-to-size with accessories separately.

Rail and Standard Accessories		Price Ctg.
3630 Universal nylon bracket, white, 100.		A
6065	Twist eye end stop.	
6283	Roller glider, 10, 100.	
6380p	Profile, white in 6m.	
6381	Endcover, white.	
11301	2C Glider in strip form at 14 per m, outer 1000.	

Optional Accessories		Price Ctg.
(additional charges may apply)		A
2255	Adjustable Brake.	
2256	Adjustable Brake.	
3571	Hook.	
3582	Hook, Box, 100. Self service sachets, 25x25. Outer, 1,000. Outer, 20,000.	
3599	Hook, box 100, outer 25,000.	
3603	Top fix bracket, white each, 10, 100.	
3620	Connecting Bridge.	
3655	Long universal bracket.	
3660	Extra long universal bracket	
6053	Spring stop, 10.	
6064	Screw twist endstop each, 10.	
6086	Spring stop each, 10, 100.	
6146	Nylon hook, 100.	
6094	Roller glider with hook, 10, 100.	
6098	Roller glider with eye, 10, 100.	
6349	Wave <sup>®</sup> curtain tape.	
6363	Iron-on hemming tape.	
6364	Extension.	
6365	Hanger.	
6366	Draw rod carrier.	
10075	Lead curtain weight.	
10076	Fabric side weight.	
10430-10434	Draw Rods, white, black or aluminium	
11295	Endstop white, black or silver.	
11302	Wave 2C Glider-cord 80mm	
11303	Wave 2C Glider-cord 60mm	
Smart Fix Brackets in white, black or silver		
11118	Smart Fix 60mm Bracket (11200 Set).	
11119	Smart Fix 80mm Bracket (11201 Set).	
11120	Smart Fix 100mm Bracket (11202 Set).	
11121	Smart Fix 120mm Bracket (11203 Set).	
11122	Smart Fix 150mm Bracket (11204 Set).	
11123	Smart Fix 200mm Bracket (11205 Set).	
Square Smart Fix Brackets in white, black or silver		
11139	Smart Fix 60mm Bracket (11210 Set).	
11140	Smart Fix 80mm Bracket (11211 Set).	
11141	Smart Fix 100mm Bracket (11212 Set).	
11142	Smart Fix 120mm Bracket (11213 Set).	
11143	Smart Fix 150mm Bracket (11214 Set).	
11144	Smart Fix 200mm Bracket (11215 Set).	
Universal Smart Fix Extension Bracket		
11154	Universal Smart Fix 120mm.	
11155	Universal Smart Fix 150mm.	
11156	Universal Smart Fix 200mm.	

Colours		Price Ctg.
Other colours special order - see Page 73.		E

Bending	Max. trade discount	33 1/3%
Angle bend £38.50 each. Standard radius 28cm.		
Semi-circle or gradual curve £49.50 each.		

System Prices		Price Ctg.	
Specific lengths charged at the nearest 25cm increment above.		A	
W/BL Standard Glider	W/BL Wave 60mm	W/BL Wave 80mm	
cm	£	£	
125	53.66	80.03	72.02
150	62.08	93.95	84.34
175	71.86	108.84	97.64
200	80.28	122.77	109.96
225	90.05	137.66	123.26
250	98.47	151.58	135.59
275	108.25	166.48	148.87
300	116.67	180.40	161.20
325	126.44	195.29	174.49
350	134.86	209.22	186.82
375	144.64	224.11	200.11
400	153.06	238.04	212.43
425	162.84	252.93	225.73
450	171.25	266.86	238.05
475	181.03	281.75	251.35
500	189.45	295.67	263.67
525	199.23	310.57	276.96
550	207.64	324.49	289.29
575	217.42	339.38	302.58
600	225.85	353.32	314.92

Above prices are for systems ready-assembled. Substantial savings can be made for self-assembly. Rail can be supplied in full lengths or cut-to-size with accessories separately.

Enhanced Wave Options		Price Ctg.
Add the following to the systems prices above:		A
Option 1		
2256 Adjustable Brake		
Single-stack £9.66; Pair-stack £19.31		
Option 2		
2255 Adjustable Brake & 6366 Carrier		
Single-stack £19.62; Pair-stack £39.22		
Option 3		
Enhanced Wave (80mm only)		
Single-stack £36.40; Pair-stack £72.83		

Rail and Standard Accessories		Price Ctg.
6466 Rail, white, black available in 6 metre lengths.		A
3060	Clamp.	
6065	Twist eye end stop, white, black 10, 100.	
6471	Endcover, white, black.	
Standard Gliders		
11301	2C Gliders in strip form, white, black, at 14 per m, outer 1000.	
Wave Gliders		
11302	Wave 2C Glider-cord 80mm, white, black.	
11303	Wave 2C Glider-cord 60mm, white, black.	

Optional Accessories		Price Ctg.
(additional charges may apply)		A
2255	Adjustable brake, white, black.	
3062	Connecting bridge.	
3582	Curtain hooks white, black.	
3599	Hook, white, black, box, 100. Self-service sachets, 25 x 25. Outer, 25,000.	
6064	Endstop.	
6349	Wave <sup>®</sup> curtain tape, white, black.	
6364	Extension, white, black.	
6365	Hanger, white, black.	
6363	Iron-on hemming tape.	
6366	Draw rod carrier, white, black.	
10075	Lead curtain weight.	
10076	Fabric side weight.	
10430-10434	Draw rods, white, black or aluminium.	
11231	Recess profile white and black.	
11237	Wedge, white and black.	
11239	Recess mask, white and black.	
1148C	Screw.	

Recess Profile and Accessories White and Black		Price Ctg.
Charged at the nearest 25cm increment above.		A
Add to price Per Metre Per Track		
White	£19.91	£4.81

Colours		Price Ctg.
Other colours special order - consult Silent Gliss for pricing.		E

Tools		Price Ctg.
7244 Notching tool for recess profile 11231		E

Bending	Max. trade discount	33 1/3%
Angle bend £38.50 each. Standard radius 12cm.		
Semi-circle or gradual curve £49.50 each.		

Note: If using recess profile, add an additional 20% to the relevant bending charge above. Please note standard radius for 6465 with recess profile is 27cm.

All prices shown exclude VAT



# Hand Operated Curtain Track Systems

## SG 6820

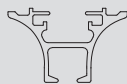

Supplied in white. Available with the Wave Standard curtain heading system. Profile available in 6 metre lengths. Top fix as standard.

27cm std.

## SG 6840

Supplied in silver anodised, white, black, matt white, antique bronze, anodic grey and charcoal. Available with Wave standard curtain headings systems. Top fix as standard.

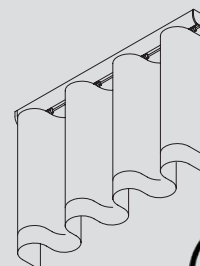

20cm std.

System Prices				Price Ctg.
Specific lengths charged at the nearest 25cm increment above.				A
cm	White Standard Glider £	White Wave 60mm £	White Wave 80mm £	
125	76.59	102.17	100.32	
150	84.54	115.47	112.82	
175	96.77	132.67	129.44	
200	104.73	145.97	141.93	
225	116.96	163.17	158.55	
250	124.92	176.47	171.04	
275	137.15	193.67	187.67	
300	145.11	206.97	200.16	
325	157.34	224.17	216.78	
350	165.30	237.47	229.27	
375	177.53	254.67	245.90	
400	185.49	267.97	258.39	
425	197.72	285.17	275.01	
450	205.68	298.47	287.50	
475	217.91	315.67	304.13	
500	225.87	328.97	316.62	
525	238.10	346.17	333.24	
550	246.06	359.47	345.73	
575	258.29	376.67	362.36	
600	266.26	389.98	374.85	

Prices above are for systems ready-assembled. Substantial savings can be made for self-assembly. Rail can be supplied in full lengths or cut-to-size with accessories separately.

### Enhanced Wave Options

Add the following to the systems prices above:

- Option 1**  
2256 Adjustable Brake  
Single-stack £9.66; Pair-stack £19.31
- Option 2**  
2255 Adjustable Brake & 6366 Carrier  
Single-stack £19.62; Pair-stack £39.22
- Option 3**  
Enhanced Wave (80mm only)  
Single-stack £36.40; Pair-stack £72.83

### Rail and Standard Accessories

- 6065 Endstop each, 10, 100.
- 6821 Rail, white in 6m.
- 6823 Endcover in white each, 10, 100.
- 1148C Screw, 31mm/1 1/4", No. 8 countersunk, 100
- 11236 Clip, 100

### Standard Gliders

11301 2C Glider in strip form at 14 per m, outer 1000.

### Wave Gliders

11302 Wave 2C Glider cord 80mm.  
11303 Wave 2C Glider cord 60mm.

All prices shown exclude VAT

Optional Accessories		Price Ctg.
(additional charges may apply)		A
2255 Adjustable Brake.		
2256 Adjustable Brake.		
3582 Hook, Box, 100. Self service sachets, 25x25. Outer, 1,000.		
3599 Hook, box 100, outer 25,000.		
3802 Connecting Bridge.		
6053 Spring stop, 10.		
6065 Twist eye endstop, each, 10.		
6086 Spring stop, each 10, 100.		
6094 Roller glider with hook, 10, 100.		
6098 Roller glider with eye, 10, 100.		
6146 Nylon hook only, 12, 100.		
6283 Roller glider, 10, 100.		
6349 Wave <sup>®</sup> curtain tape (per m).		
6363 Iron-on hemming tape.		
6364 Extension.		
6365 Hanger.		
6366 Draw rod carrier.		
10075 Lead curtain weight.		
10076 Fabric side weight.		
10430-10434 Draw Rods, white, black or aluminium.		
11295 Endstop white, black or silver.		

### Colours

Other colours special order - see Page 73.

### Tools

6827 Funnel Fixing Tool

### Bending

Max. trade discount 33 1/3%

Angle bend £60.50 each.  
Standard radius 27cm.  
Gradual curve £81.50 each.

System Prices				Price Ctg.
Using Standard Gliders				A
cm	W/S/BL £	MW/AG/AB/CC £	Using Roller Gliders W/S £	MW/AG/AB/CC £
125	67.69	96.96	82.64	111.18
150	70.92	106.04	88.84	123.10
175	81.67	122.65	102.73	142.59
200	92.43	139.26	116.32	161.99
225	103.19	155.87	130.12	181.41
250	113.94	172.47	143.93	200.92
275	124.69	189.08	157.71	216.73
300	135.46	212.56	171.55	246.60
325	146.20	219.33	185.79	256.27
350	153.99	235.94	196.02	275.76
375	161.46	249.26	206.36	291.83
400	172.22	265.87	220.08	311.36
425	182.97	282.48	233.84	330.85
450	193.73	299.09	247.56	350.32
475	201.21	312.42	258.10	366.44
500	211.96	329.03	271.70	385.84
525	222.72	345.64	285.46	405.35
550	230.19	358.97	295.94	421.59
575	240.95	375.57	309.75	440.93
600	251.71	392.19	323.49	460.47

Using Standard Wave Gliders				Using Wave Roller Gliders			
60mm glider cord		80mm glider cord		80mm glider cord			
cm	W/S/BL £	MW/AG/AB/CC £	W/S/BL £	MW/AG/AB/CC £	W/S/BL £	MW/AG/AB/CC £	
125	87.55	116.82	85.27	114.53			
150	99.48	134.60	96.98	132.10			
175	115.00	155.97	111.68	152.65			
200	130.52	177.34	126.36	173.19			
225	146.03	198.71	141.67	194.35			
250	161.55	220.08	156.36	214.90			
275	173.48	237.87	167.96	232.47			
300	189.45	269.69	193.22	263.46			
325	205.12	281.22	198.08	274.17			
350	220.64	302.59	213.38	295.34			
375	232.88	320.68	224.79	312.59			
400	248.39	342.05	239.49	333.14			
425	263.91	363.42	254.79	354.30			
450	279.43	384.79	269.49	374.84			
475	291.66	402.88	281.51	392.72			
500	307.18	424.25	296.20	413.27			
525	322.70	445.62	313.41	433.81			
550	334.93	463.71	322.92	454.35			
575	350.45	485.08	337.61	472.24			
600	365.97	506.45	352.32	492.80			

Using Wave Roller Gliders		
80mm glider cord		
cm	W/S £	MW/AG/AB/CC £
125	150.83	179.37
150	170.67	204.93
175	198.20	238.06
200	225.43	271.10
225	252.86	304.16
250	280.32	337.31
275	303.99	366.76
300	341.79	410.27
325	359.40	433.57
350	386.85	466.70
375	410.94	496.42
400	438.30	529.58
425	465.70	562.71
450	493.06	595.81
475	517.23	625.57
500	544.48	658.61
525	571.86	691.76
550	595.99	721.64
575	623.44	754.62
600	650.83	787.80

### Enhanced Wave Options

Add the following to the systems prices above:

- Option 1**  
2256 Adjustable Brake  
Single-stack £9.66; Pair-stack £19.31
- Option 2**  
2255 Adjustable Brake & 6366 Carrier  
Single-stack £19.62; Pair-stack £39.22
- Option 3**  
Enhanced Wave (80mm only)  
Single-stack £36.40; Pair-stack £72.83

Rail and Standard Accessories		Price Ctg.
		A
3825 Clamp, at 300mm centres, 10, 100.		
3841 Rail, silver, white, matt white, black, antique bronze, anodic grey, charcoal available in 6m or cut-to-size.		
3842 Endcover.		
6065 Twist eye endstop, white, black.		
1148C Screw, 31mm/1 1/4", No. 8 countersunk, 100.		
Plus one of the following glider options:		
<b>Standard Gliders</b>		
11301 2C Gliders in strip form, W/BL at 14 per m.		
<b>Roller Gliders</b>		
6283 Roller gliders white at 10 per m.		
<b>Wave Gliders</b>		
11302 Wave 2C Glider-cord 80mm, W/BL.		
11303 Wave 2C Glider-cord 60mm, W/BL.		
6099 Roller glider-cord white 80mm pitch.		
1148C Screw, 31mm/1 1/4", No. 8 countersunk, 100		

### Optional Accessories

(additional charges may apply).

- 2255 Adjustable brake, white, black.
- 2256 Adjustable brake, white, black
- 3582 Hook, Box, 100. Self-service sachets, white, black 25 x 25. Outer, 20,000.
- 3599 Hook, Box, white, black 100. Self service sachets, 25x25. Outer, 25,000.
- 3802 Connecting bridge.
- 3826 Nylon bracket, (top fix), white, black.
- 3832 Clamp for top fixing.
- 3836 Nylon bracket, (face fix).
- 6053 Spring stop, 10.
- 6094 Roller glider with hook, 10, 100.
- 6098 Roller glider with eye, white, black.
- 6349 Wave<sup>®</sup>curtain tape, white, black.
- 6364 Extension, white, black.
- 6365 Hanger, white, black.
- 6363 Iron-on hemming tape.
- 6366 Draw rod carrier, white, black.
- 10075 Lead curtain weight.
- 10076 Fabric side weight.
- 10430 - 10434 Draw rods, white, black or aluminium

### Smart Fix Brackets in W/S/BL/MW/AG/AB/CC

- 11118 Smart Fix 60mm Bracket (11200 Set).
- 11119 Smart Fix 80mm Bracket (11201 Set).
- 11120 Smart Fix 100mm Bracket (11202 Set).
- 11121 Smart Fix 120mm Bracket (11203 Set).
- 11122 Smart Fix 150mm Bracket (11204 Set).
- 11123 Smart Fix 200mm Bracket (11205 Set).

### Square Smart Fix Brackets in W/S/BL/MW/AG/AB/CC

- 11139 Smart Fix 60mm Bracket (11210 Set).
- 11140 Smart Fix 80mm Bracket (11211 Set).
- 11141 Smart Fix 100mm Bracket (11212 Set).
- 11142 Smart Fix 120mm Bracket (11213 Set).
- 11143 Smart Fix 150mm Bracket (11214 Set).

- 11144 Smart Fix 200mm Bracket (11215 Set).
- Smart Fix Brackets Covers**
- 11116 Smart Fix Bracket Cover.
- 11137 Square Smart Fix Bracket Cover.

### Colours

Other colours special order—see page 73.

### Tools

- 0538 Bending kit for use with 7103/7109.
- 7103 Portable hand operated bending tool.
- 7109 Portable electrically operated bending tool.
- 7802 Filler set 3840 at 200cm for 7103/9.

### Bending

Max. trade discount 33 1/3%

Angle bend £60.50 each.  
Standard radius 20cm.  
Semi-circle or gradual curve £81.50 each.





# Hand Operated Curtain Track Systems

## SG 6870

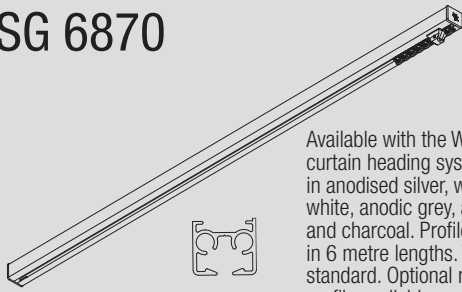

Available with the Wave Standard curtain heading systems. Supplied in anodised silver, white, black, matt white, anodic grey, antique bronze and charcoal. Profile available in 6 metre lengths. Top fix standard. Optional recess profile available.

26cm std.

## SG 6970

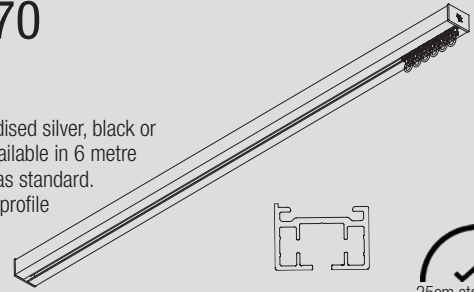

Supplied in anodised silver, black or white. Profile available in 6 metre lengths. Top fix as standard. Optional recess profile available.

25cm std.

### System Prices

Specific lengths charged at the nearest 25cm increment above.

#### Using Standard Gliders

cm	W/S/BL	MW/AG/AB/CC
£	£	£
125	73.10	102.74
150	80.98	115.89
175	92.27	132.47
200	100.15	145.63
225	111.45	162.21
250	119.33	175.37
275	130.62	191.95
300	138.50	205.11
325	149.80	221.69
350	157.68	234.85
375	168.97	251.43
400	176.85	264.59
425	188.15	281.16
450	196.03	294.33
475	207.32	310.90
500	215.20	324.07
525	226.50	340.64
550	234.38	353.80
575	245.67	370.38
600	253.54	383.56

#### Using 60mm Standard Wave Gliders

cm	W/S/BL	MW/AG/AB/CC
£	£	£
125	98.68	132.21
150	111.91	151.27
175	128.16	173.47
200	141.39	192.54
225	157.65	214.73
250	170.88	233.80
275	187.14	255.99
300	200.36	275.06
325	216.62	297.25
350	229.85	316.32
375	246.11	338.52
400	259.34	357.59
425	275.59	379.78
450	288.82	398.85
475	305.08	421.04
500	318.31	440.11
525	334.56	462.30
550	347.79	481.37
575	364.05	503.57
600	377.28	522.65

#### Using 80mm Standard Wave Gliders

cm	W/S/BL	MW/AG/AB/CC
£	£	£
125	96.02	124.23
150	108.35	141.70
175	123.88	162.29
200	136.21	179.77
225	151.74	200.36
250	164.07	217.84
275	179.60	238.43
300	191.93	255.91
325	207.46	276.50
350	219.80	293.98
375	235.33	314.57
400	247.66	332.05
425	263.19	352.64
450	275.52	370.12
475	291.05	390.71
500	303.38	408.19
525	318.91	428.78
550	331.25	446.26
575	346.78	466.85
600	359.10	484.35

Prices above are for systems ready-assembled. Substantial savings can be made for self-assembly. Rail can be supplied in full lengths or cut-to-size with accessories separately.

### Enhanced Wave Options

Add the following to the systems prices above:

- Option 1**  
2256 Adjustable Brake  
Single-stack £9.66; Pair-stack £19.31
- Option 2**  
2255 Adjustable Brake & 6366 Carrier  
Single-stack £19.62; Pair-stack £39.22
- Option 3**  
Enhanced Wave (80mm only)  
Single-stack £36.40; Pair-stack £72.83

### Rail and Standard Accessories

- 3825 Clamp, 10, 100.  
6065 Endstop, white, black.  
11190 Profile, silver, white, black, matt white, anodic grey, antique bronze, charcoal in 6m.  
1148C Screw, 31mm/1 1/4", No. 8 countersunk, 100  
11233 Endcover silver, white, matt white, black, anodic grey, antique bronze, charcoal.  
**Standard Gliders**  
11301 2C Glider in strip form, white, black at 14 per m, outer 1000.  
**Wave Gliders**  
11302 Wave 2C Glider-cord 80mm, white, black.  
11303 Wave 2C Glider-cord 60mm, white, black.

### Optional Accessories

- (additional charges may apply)  
2255 Adjustable Brake, white, black.  
2256 Adjustable brake, white, black.  
3582 Hook, white, black, Box, 100.  
Self service sachets, 25x25. Outer, 1,000 Outer, 20,000.  
3599 Hook, box 100, outer 25,000.  
3802 Connecting Bridge.  
3826 Nylon bracket, white, black (top fix).  
3832 Clamp for top fixing.  
3836 Nylon bracket, (face fix).  
6053 Spring stop, 10.  
6064 Endstop.  
6086 Spring stop, white, black each 10, 100.  
6094 Roller glider with hook, 10, 100.  
6098 Roller glider with eye, white, black 10,100.  
6099 Roller glider - cord 80mm pitch. Outer of 50m.  
6146 Nylon hook only, 12, 100.  
6283 Roller glider, 10, 100.  
6349 Wave® curtain tape, white, black.  
6364 Extension, white, black.  
6365 Hanger, white, black.  
6363 Iron-on hemming tape.  
6366 Draw rod carrier, white, black.  
10075 Lead curtain weight.  
10076 Fabric side weight.  
10157 Wedge, white, black.  
10430-10434 Draw Rods, white, black or aluminium  
11230 Recess profile, white and black 6m  
11238 Recess Mask, white and black  
11295 Endstop white, black or silver.

### Smart Fix Brackets in W/S BL/MW/AG/AB/CC

- 11118 Smart Fix 60mm Bracket (11200 Set).  
11119 Smart Fix 80mm Bracket (11201 Set).  
11120 Smart Fix 100mm Bracket (11202 Set).  
11121 Smart Fix 120mm Bracket (11203 Set).  
11122 Smart Fix 150mm Bracket (11204 Set).  
11123 Smart Fix 200mm Bracket (11205 Set).  
**Square Smart Fix Brackets in W/S BL/MW/AG/AB/CC**  
11139 Smart Fix 60mm Bracket (11210 Set).  
11140 Smart Fix 80mm Bracket (11211 Set).  
11141 Smart Fix 100mm Bracket (11212 Set).  
11142 Smart Fix 120mm Bracket (11213 Set).  
11143 Smart Fix 150mm Bracket (11214 Set).  
11144 Smart Fix 200mm Bracket (11215 Set).  
**Universal Smart Fix Extension Bracket**  
11154 Universal Smart Fix 120mm.  
11155 Universal Smart Fix 150mm.  
11156 Universal Smart Fix 200mm.

### Recess Profile and Accessories White or Black

Charged at the nearest 25cm increment above.  
Add to price Per Metre Per Track  
White £29.98 £10.69

**Colours**  
Other colours special order - see Page 73.

**Tools**  
7245 Notching tool for recess profile 11230

**Bending** Max. trade discount 33 1/3%

Angle bend £60.50 each. Standard radius 26cm.  
Semi-circle or gradual curve £81.50 each.  
**Note:** If using recess profile, add an additional 20% to the relevant bending charge above.  
**Please Note:** Minimum radius for 6870 with recess profile is 50cm.

### System Prices

Specific lengths charged at the nearest 25cm increment above.

#### Silver, Black or White

cm	Std	60mm	80mm
	Roller Glider	Roller Wave	Roller Wave
£	£	£	£
125	142.81	236.33	203.33
150	160.26	275.40	235.80
175	184.90	316.80	270.60
200	202.35	355.87	303.06
225	226.98	397.27	337.86
250	244.43	436.33	370.33
275	269.07	477.73	405.13
300	286.52	516.80	437.59
325	311.16	558.20	472.39
350	328.61	597.26	504.86
375	353.24	638.66	539.66
400	370.69	677.73	572.12
425	395.33	719.13	606.92
450	412.78	758.20	639.39
475	437.42	799.60	674.19
500	454.86	838.66	706.65
525	479.50	880.06	741.45
550	496.95	919.13	773.92
575	521.59	960.53	808.72
600	539.05	999.63	841.20

Prices above are for systems ready-assembled. Substantial savings can be made for self-assembly. Rail can be supplied in full lengths or cut-to-size with accessories separately.

### Rail and Standard Accessories

- 3004 Clamps, 10, 100.  
11235 Endcover silver, black and white.  
11295 Endstop white and black.

10840 2C Roller glider, white, black at 10 per m, outer 10, 100.

10850 Rail, Silver, Black and White in 6m.

10852 Wave 2C Roller Cord 80mm, white, black.

10869 Wave 2C Roller Cord 60mm, white, black.

### Optional Accessories

- (additional charges may apply)  
3041 Bracket.  
3582 Curtain hook, white, black box, 100  
Self service sachets, 25 x 25.  
Outer, 20,000.  
6105 Hanger with plate  
6107 V-Hanger with plate  
6349 Wave® curtain tape, white, black.  
6363 Iron-on hemming tape.  
7002 Profile protector.  
10075 Lead weight 50/gr/m.  
10076 Fabric weight.  
10430 -10434 Draw Rods, white, black or aluminium.

### Smart Fix Brackets in white, black or silver.

- 11118 Smart Fix 60mm Bracket (11200 Set).  
11119 Smart Fix 80mm Bracket (11201 Set).  
11120 Smart Fix 100mm Bracket (11202 Set).  
11121 Smart Fix 120mm Bracket (11203 Set).  
11122 Smart Fix 150mm Bracket (11204 Set).  
11123 Smart Fix 200mm Bracket (11205 Set).

### Square Smart Fix Brackets in white, black or silver.

- 11139 Smart Fix 60mm Bracket (11210 Set).  
11140 Smart Fix 80mm Bracket (11211 Set).  
11141 Smart Fix 100mm Bracket (11212 Set).  
11142 Smart Fix 120mm Bracket (11213 Set).  
11143 Smart Fix 150mm Bracket (11214 Set).  
11144 Smart Fix 200mm Bracket (11215 Set).

### Universal Smart Fix Extension Brackets

- 11154 Universal Smart Fix 120mm.  
11155 Universal Smart Fix 150mm.  
11156 Universal Smart Fix 200mm.

5118 Wedge for recess profile, W/BL  
10831 Connecting Bridge.

- 10862 Recess profile, white or black, per meter.  
10864 Recess mask, belt return, white, black.  
10865 Mounting support plate.  
11465 Springstop

### Recess Profile and Accessories White or Black

Charged at the nearest 25cm increment above.  
Add to price Per Metre Per Track  
White £52.59 £9.94

**Colours**  
Other colours special order - see Page 73.

**Tools**  
7246 Notching tool for recess profile 10862

**Bending** Max. trade discount 25%

For each bend add the following to above system price:  
Radius/cm  
25-99 £182.00 each.  
Over 99 £342.00 each.

**Note:** If using recess profile, add an additional 20% to the relevant bending charge above.  
Please note: Standard radius for 6970 is 25cm. Minimum radius for 6970 with recess profile is 50cm.

All prices shown exclude VAT



# Cord Operated Curtain Track Systems

## SG 3000

Supplied in white. Profile available in 5 or 6 metre lengths.

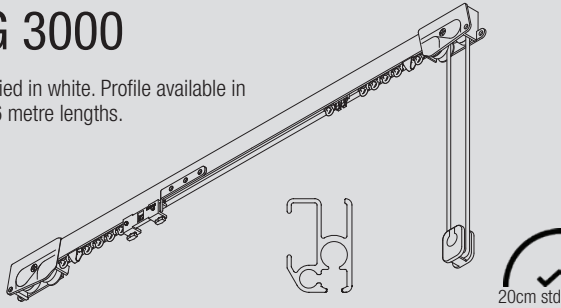

## SG 3840

Supplied in anodised silver, white, black, matt white, anodic grey, antique bronze and charcoal. Available in 6 metre lengths only. Available with the Wave Standard curtain heading systems. Top fixed as standard.

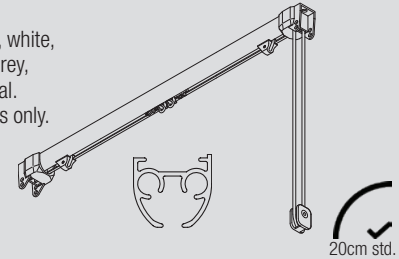

System Prices		Price Ctg.
Specific lengths charged at the nearest 25cm increment above.		A
cm	White £	
125	113.11	
150	120.96	
175	128.83	
200	136.75	
225	144.53	
250	152.41	
275	160.28	
300	168.14	
325	175.94	
350	183.79	
375	191.71	
400	199.57	
425	207.42	
450	215.22	
475	223.15	
500	230.97	
525	238.82	
550	246.71	
575	254.52	
600	262.39	

Above prices are for systems ready - assembled. Substantial savings can be made for self-assembly. Rail can be supplied in full lengths or cut-to-size with accessories separately.

Rail and Standard Accessories		Price Ctg.
		A
18R Screw 25mm/1", No. 8 round head, 100.		
1082 Rail, white in 5m, 6m.		
1105 Spacer for cord pull end.		
1348R Screw round head No. 8 44mm/1 3/4" for spacer 1105, 100.		
3070 Twist eye endstop, each 10.		
3090 Cord 100, metres, 500 metres.		
3242 Overlap, each, 10, 100. Euroslot sachet 1.		
3288 Pair of endpieces, including Pilot runners 3030/3213, white. Outer, 25 sets, per set.		
3533 Glider. Box, 100. Self-service sachets, 25 x 25. Outer, 25,000. Euroslot sachet 25.		
3534 Glider, in strip form, 14 per metre. Outer, 1,000 gliders.		
3630 Universal bracket, white, each, 10, 100, Euroslot sachet 2.		

10731 Cord retainer		Price Ctg.
		E

All prices shown exclude VAT

Optional Accessories		Price Ctg.
(Additional charges may apply)		A
1128R Screw 36mm/1 1/2", No. 8 round head, 100.		
3020 Hook. Metal, 100.		
3032 Springstop, 10, 100.		
3045 Metal overlap arm, each, 10.		
3151 Clearance spacer (for top boards).		
3208 Intermediate pulley, white, grey, antique bronze, black, gold, each, 10.		
3231 End fixing bracket, each, 10.		
3289/3289W Set end pieces with return, including pilot runners, set.		
3511 Glider, at 16 per metre, 100. Outer, 25,000 gliders.		
3562 Standard tape, 100 metres.		
3570 Rotating glider, 100.		
3571 Hook. Box 100. Self-service sachets, 25 x 25. Outer 35,000. Euroslot sachet 25.		
3582 Hook. Box, 100 Self-service sachets, 25 x 25. Euroslot sachets 25. Outer, 1000. Outer, 20,000.		
3599 Hook. Box, 100. Self-service sachets, 25 x 25. Euroslot sachet 25. Outer, 25,000.		
3603 Top fix brackets, white at 600mm centres each, 100. Euroslot sachet 2.		
3620 Connecting bridge, each.		
3655 Long universal bracket.		
3660 Extra long universal bracket.		
Smart Fix Brackets in white, black or silver		
11118 Smart Fix 60mm Bracket (11200 Set).		
11119 Smart Fix 80mm Bracket (11201 Set).		
11120 Smart Fix 100mm Bracket (11202 Set).		
11121 Smart Fix 120mm Bracket (11203 Set).		
11122 Smart Fix 150mm Bracket (11204 Set).		
11123 Smart Fix 200mm Bracket (11205 Set).		
Square Smart Fix Brackets in white, black or silver		
11139 Smart Fix 60mm Bracket (11210 Set).		
11140 Smart Fix 80mm Bracket (11211 Set).		
11141 Smart Fix 100mm Bracket (11212 Set).		
11142 Smart Fix 120mm Bracket (11213 Set).		
11143 Smart Fix 150mm Bracket (11214 Set).		
11144 Smart Fix 200mm Bracket (11215 Set).		
Smart Fix Bracket Covers		
11116 Smart Fix Bracket Cover.		
11137 Square Smart Fix Bracket Cover.		

Colours		Price Ctg.
Other colours special order - see page 73.		E

Tools		Price Ctg.
		E
SL3000 Reel, sleeving.		
SL3000W Reel, sleeving. 80018		
Slotting tool. 7103 Portable hand operated bending tool.		
7004 Cording needle.		
7109 Portable electrically operated bending tool.		
Instruction leaflet.		
7805 Filler set 3000 at 200cm for 7103/9.		
0540 Bending tool for gradual curves.		

Bending		Max. trade discount
		33 1/3%
Angle bend £44.50 each.		
Standard radius 20cm.		
Gradual curve £65.50 each.		

System Prices		Using Standard Gliders		Using Roller Gliders		Price Ctg.	
cm	W/S/BL £	MW/AG/AB/CC £	W/S/BL £	MW/AG/AB/CC £	W/S/BL £	MW/AG/AB/CC £	A
150	120.25	156.64	138.16	174.56			
175	131.14	172.19	152.17	193.27			
200	142.16	187.84	166.04	211.74			
225	153.15	203.43	180.09	230.36			
250	164.09	218.97	194.04	248.94			
275	175.07	234.59	207.91	267.46			
300	186.08	250.16	221.87	285.97			
325	196.93	265.75	235.77	307.31			
350	207.91	281.29	249.85	323.19			
375	218.88	296.93	263.78	341.85			
400	229.88	312.49	277.72	360.34			
425	240.80	328.06	291.67	378.91			
450	251.80	343.65	305.62	397.45			
475	262.72	359.19	319.63	416.09			
500	273.79	374.83	333.56	434.56			
525	284.71	390.38	347.49	453.12			
550	295.70	405.96	361.44	471.67			
575	306.64	421.60	375.44	490.41			
600	317.65	437.11	389.42	508.89			

Using Standard Wave Gliders		60mm glider-cord		80mm glider-cord		
cm	W/S/BL £	MW/AG/AB/CC £	W/S/BL £	MW/AG/AB/CC £	W/S/BL £	MW/AG/AB/CC £
150	149.29	185.69	144.04	180.43		
175	165.02	206.08	158.48	199.54		
200	180.89	226.58	173.07	218.75		
225	196.71	247.00	188.20	238.39		
250	212.48	267.37	202.70	257.59		
275	228.31	287.85	217.85	277.40		
300	244.17	308.26	232.43	296.52		
325	259.86	328.69	246.84	315.66		
350	275.70	349.06	262.00	335.36		
375	291.50	369.55	276.52	354.56		
400	307.34	389.95	291.08	373.69		
425	323.09	410.36	306.15	393.42		
450	338.94	430.76	320.73	412.54		
475	354.72	451.19	335.82	432.30		
500	370.63	471.65	350.45	451.47		
525	386.40	492.05	364.95	470.59		
550	402.21	512.45	380.07	490.33		
575	417.98	532.95	394.57	509.54		
600	433.84	553.33	409.14	528.63		

Using Wave Roller Gliders		80mm glider cord	
cm	W/S £	MW/AG/AB/CC £	W/S £
150	219.99	256.39	
175	247.65	288.71	
200	275.15	320.84	
225	302.81	353.10	
250	330.43	385.32	
275	357.94	417.47	
300	385.53	449.62	
325	413.08	481.91	
350	440.77	514.14	
375	468.35	546.39	
400	495.94	578.56	
425	523.51	610.77	
450	551.12	642.93	
475	578.74	675.22	
500	606.31	707.32	
525	633.87	739.52	
550	661.48	771.73	
575	689.11	804.08	
600	716.76	836.24	

Track lengths between those specified will be charged at the rate for the nearest standard length above.

Above prices are for systems ready-assembled. Substantial savings can be made for self-assembly. Rail can be supplied in full lengths or cut-to-size with accessories separately.



# Cord Operated Curtain Track Systems

## SG 3840

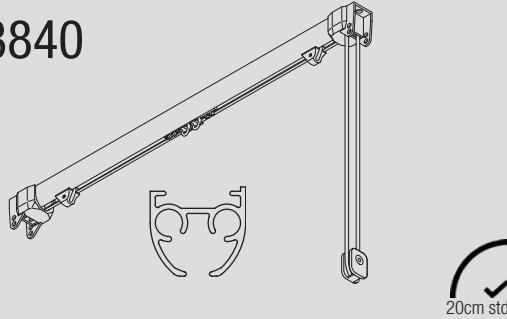

## SG 3870

Supplied in anodised silver, white, black, matt white, anodic grey, antique bronze and charcoal. Available with the Wave Standard curtain heading systems. Available in 6 metre lengths. Top fix as standard. Optional recess profile available.

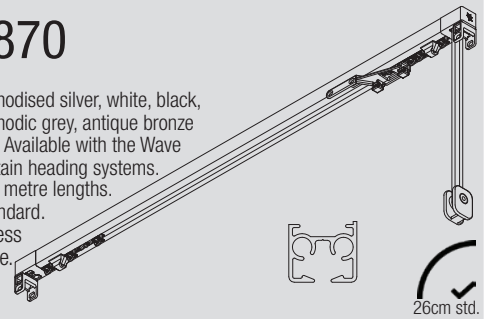

	Price Ctg.
<b>Rail and Standard Accessories</b>	<b>A</b>
1148C Screw, 31mm/1 1/4", No. 8 countersunk, 100.	
3090 Cord, 100 metres. 500 metres.	
3091 Cord, 100 metres. black.	
3825 Clamp, 10, 100.	
3841 Rail, silver, white, black, matt white, anodic grey, antique bronze, charcoal available in 6m.	
3845 Endpiece set, white, black, grey, matt white, anodic grey, antique bronze, charcoal.	
6086 Spring stop, white, black each 10, 100.	
6288 Plastic overlap arm white, black, each, 10.	
Plus one of the following glider options:	
<b>Standard Gliders</b>	
11301 2C Gliders in strip form white, black, at 14 per m, outer 1000.	
<b>Roller Gliders</b>	
6283 Roller glider, white at 10 per metre. Outer 10, 100.	
<b>Wave Gliders</b>	
6099 Roller glider-cord, white 80mm pitch. Outer of 50mm.	
11302 2C Wave glider-cord 80mm, white, black	
11303 2C Wave glider-cord 60mm, white, black	
10731 Cord retainer	<b>A</b>
<b>Optional Accessories</b> (additional charges may apply).	
3020 Hook. Metal, 100.	
3562 Standard tape, 100 metres.	
3571 Hook, Box 100. Self-service sachets, 25 x 25. Outer, 35,000.	
3582 Curtain hooks, white, black.	
3582 Hook. Box, 100. Self-service sachets, 25 x 25. Outer, 20,000.	
3599 Hook, white, black Box 100. Self-service sachets, 25 x 25. Outer, 25,000.	
3802 Connecting bridge, each.	
3826 Nylon bracket, white, black (top fix).	
3832 Clamp for top fixing.	
3833A Intermediate pulley, white, black each.	
3836 Nylon bracket, (face fix).	
3846 Endpieces set with return including pair of pilot runners and 2 x 3816 endpieces, white.	
6063 Overlap arm, each, 10.	
6094 Roller glider with hook, 10, 100.	
6098 Roller glider with eye, white, black.	
6099 Roller glider, white cord 80mm.	
6349 Wave® curtain tape, white, black.	
6363 Iron-on hemming tape.	
6364 Extension, white, black.	
6365 Hanger, white, black.	

All prices shown exclude VAT

	Price Ctg.
<b>Smart Fix Brackets in W/S/BL/MW/AG/AB/CC</b>	<b>A</b>
11118 Smart Fix 60mm Bracket (11200 Set).	
11119 Smart Fix 80mm Bracket (11201 Set).	
11120 Smart Fix 100mm Bracket (11202 Set).	
11121 Smart Fix 120mm Bracket (11203 Set).	
11122 Smart Fix 150mm Bracket (11204 Set).	
11123 Smart Fix 200mm Bracket (11205 Set).	
<b>Square Smart Fix Brackets in W/S/BL/MW/AG/AB/CC</b>	
11139 Smart Fix 60mm Bracket (11210 Set).	
11140 Smart Fix 80mm Bracket (11211 Set).	
11141 Smart Fix 100mm Bracket (11212 Set).	
11142 Smart Fix 120mm Bracket (11213 Set).	
11143 Smart Fix 150mm Bracket (11214 Set).	
11144 Smart Fix 200mm Bracket (11215 Set).	
<b>Smart Fix Bracket Covers</b>	
11116 Smart Fix Bracket Cover.	
11137 Square Smart Fix Bracket Cover.	
<b>Universal Smart Fix Extension Bracket</b>	
11154 Universal Smart Fix 120mm.	
11155 Universal Smart Fix 150mm.	
11156 Universal Smart Fix 200mm	
<b>Colours</b>	<b>E</b>
Other colours special order – see page 73.	
<b>Tools</b>	<b>E</b>
7103 Portable hand operated bending tool.	
7109 Portable electrically operated bending tool.	
7802 Filler set 3840 at 200cm for 7103/9.	
<b>Enhanced Wave® System supplement</b> per system £	
80mm Single-stack 23.09	
80mm Pair-stack 46.22	
<b>Bending</b>	<b>Max. trade discount 33 1/3%</b>
Angle bend £60.50 each.	
Standard radius 20cm.	
Semi-circle or gradual curve £81.50 each.	

	Price Ctg.
<b>System Prices</b> Specific lengths charged at the nearest 25cm increment above.	<b>A</b>
<b>Using Standard Gliders</b>	
cm W/S/BL MW/AG/AB/CC £ £	
125 116.62 153.08	
150 125.76 167.24	
175 139.44 184.83	
200 147.59 198.99	
225 160.27 216.58	
250 169.42 230.74	
275 182.10 248.34	
300 191.25 262.50	
325 203.94 280.09	
350 213.09 294.25	
375 225.77 311.84	
400 234.92 326.00	
425 247.60 343.59	
450 256.75 357.76	
475 269.43 375.35	
500 278.58 389.51	
525 291.26 407.10	
550 300.41 421.26	
575 313.09 438.85	
600 322.26 453.04	
<b>Using 60mm Standard Wave Gliders</b>	
cm W/S/BL MW/AG/AB/CC £ £	
125 142.97 178.66	
150 157.63 198.17	
175 175.42 220.72	
200 190.08 240.23	
225 207.88 262.79	
250 222.54 282.29	
275 240.33 304.85	
300 254.99 324.36	
325 272.78 346.91	
350 287.44 366.42	
375 305.24 388.98	
400 319.90 408.48	
425 337.69 431.04	
450 352.35 450.55	
475 370.15 473.10	
500 384.80 492.61	
525 402.60 515.16	
550 417.26 534.67	
575 435.05 557.23	
600 449.72 576.76	
<b>Using 80mm Standard Wave Gliders</b>	
cm W/S/BL MW/AG/AB/CC £ £	
125 134.99 170.92	
150 148.05 188.87	
175 164.25 209.88	
200 177.31 227.84	
225 193.51 248.84	
250 206.57 266.80	
275 222.77 287.81	
300 235.84 305.77	
325 252.03 326.77	
350 265.10 344.73	
375 281.30 365.74	
400 294.36 383.70	
425 310.56 404.70	
450 323.62 422.66	
475 339.82 443.67	
500 352.88 461.63	
525 369.08 482.63	
550 382.14 500.59	
575 398.34 521.60	
600 411.41 539.57	
Prices above are for systems ready-assembled. Substantial savings can be made for self-assembly. Rail can be supplied in full lengths or cut-to-size with accessories separately.	
<b>Enhanced Wave® System supplement</b> per system £	
80mm Single-stack 23.09	
80mm Pair-stack 46.22	
<b>Rail &amp; Standard Accessories</b>	
3090 Cord 100, metres, 500 metres, white.	
3091 Cord, loom, black.	
3825 Clamp at 30cm intervals, 10, 100.	
6086 Spring stop, white, black each 10, 100.	
6288 Plastic overlap arm, white, black each, 10.	
11190 Rail, silver, white, black, matt white, anodic grey, antique bronze, charcoal in 6m.	
11285 Guide set, silver, white, black matt white, anodic grey, antique bronze, charcoal.	
1148C Screw, 31mm/1 1/4", No. 8 countersunk, 100.	

	Price Ctg.
<b>Standard Gliders</b>	
11301 2C Glider in strip form, white, black at 14 per m, outer 1000.	
<b>Wave Gliders</b>	
11302 Wave 2C Glider-cord 80mm, white, black.	
11303 Wave 2C Glider-cord 60mm, white, black.	
10731 Cord retainer, white, black.	<b>E</b>
<b>Optional Accessories</b> (Additional charges may apply)	<b>A</b>
3020 Hook. Metal, 100.	
3571 Hook. Box, 100. Self-service sachets, 25 x 25. Outer, 35,000.	
3582 Hook, white, black Box, 100. Self-service sachets, 25 x 25. Outer, 25,000.	
3599 Hook, white, black Box, 100. Self-service sachets, 25 x 25. Outer, 25,000.	
3802 Connecting bridge, each.	
3826 Nylon bracket, white, black (top fix).	
3832 Clamp for top fixing.	
3836 Nylon bracket, (face fix).	
6053 Spring Stop, 10.	
6063 Overlap arm, each, 10.	
6064 Endstop.	
6065 Twist eye endstop, white, black each, 10.	
6094 Roller glider with hook, 10, 100.	
6098 Roller glider with eye, white, black 10, 100.	
6283 Roller glider, white, 10, 100.	
6349 Wave® curtain tape, white, black.	
6363 Iron-on hemming tape.	
6364 Extension, white, black.	
6365 Hanger, white, black.	
10075 Lead weight 50 gr/m.	
10076 Fabric weight.	
10157 Wedge for recess profile, white, black.	
11230 Recess profile white or black in 6m.	
11238 Recess mask, white, black.	
11295 Endstop, white, silver or black each 10.	
<b>Smart Fix Brackets in W/S/BL/MW/AG/AB/CC</b>	
11118 Smart Fix 60mm Bracket (11200 Set).	
11119 Smart Fix 80mm Bracket (11201 Set).	
11120 Smart Fix 100mm Bracket (11202 Set).	
11121 Smart Fix 120mm Bracket (11203 Set).	
11122 Smart Fix 150mm Bracket (11204 Set).	
11123 Smart Fix 200mm Bracket (11205 Set).	
<b>Square Smart Fix Brackets in W/S/BL/MW/AG/AB/CC</b>	
11139 Smart Fix 60mm Bracket (11210 Set).	
11140 Smart Fix 80mm Bracket (11211 Set).	
11141 Smart Fix 100mm Bracket (11212 Set).	
11142 Smart Fix 120mm Bracket (11213 Set).	
11143 Smart Fix 150mm Bracket (11214 Set).	
11144 Smart Fix 200mm Bracket (11215 Set).	
<b>Smart Fix Bracket Covers</b>	
11116 Smart Fix Bracket Cover.	
11137 Square Smart Fix Bracket Cover.	
<b>Universal Smart Fix Extension Bracket</b>	
11154 Universal Smart Fix 120mm.	
11155 Universal Smart Fix 150mm.	
11156 Universal Smart Fix 200mm.	
<b>Recess Profile and Accessories White or Black</b> Charged at the nearest 25cm increment above.	<b>A</b>
Add to price Per Metre Per Track	
White £29.98 £10.69	
<b>Tools</b>	<b>E</b>
7245 Notching tool for recess profile 11230	
<b>Bending</b>	<b>Max. trade discount 33 1/3%</b>
Angle bend £60.50 each.	
Standard radius 26cm.	
Semi-circle or gradual curve £81.50 each.	
<b>Note:</b> If using recess profile, add an additional 20% to the relevant bending charge above.	
Please note: Standard angle radius with recess profile is 50cm	





# Cord Operated Curtain Track Systems

## SG 3900

Supplied in White. Profile available in 5 metre or 6 metre lengths.

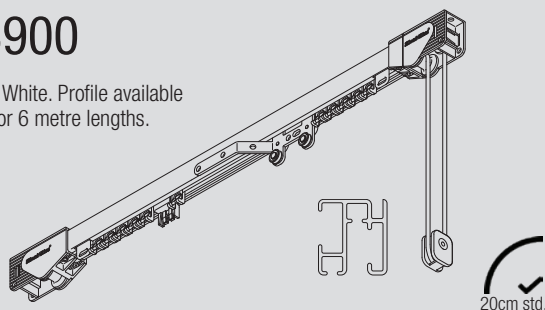

	Price Ctg.		Price Ctg.																																																															
<p><b>System Prices</b> Specific lengths charged at the nearest 25cm increment above.</p> <table border="1"> <thead> <tr> <th>cm</th> <th>White</th> <th>£</th> </tr> </thead> <tbody> <tr><td>125</td><td>113.80</td><td></td></tr> <tr><td>150</td><td>124.97</td><td></td></tr> <tr><td>175</td><td>136.24</td><td></td></tr> <tr><td>200</td><td>147.34</td><td></td></tr> <tr><td>225</td><td>158.64</td><td></td></tr> <tr><td>250</td><td>169.82</td><td></td></tr> <tr><td>275</td><td>181.05</td><td></td></tr> <tr><td>300</td><td>192.27</td><td></td></tr> <tr><td>325</td><td>203.44</td><td></td></tr> <tr><td>350</td><td>214.66</td><td></td></tr> <tr><td>375</td><td>225.89</td><td></td></tr> <tr><td>400</td><td>237.09</td><td></td></tr> <tr><td>425</td><td>248.23</td><td></td></tr> <tr><td>450</td><td>259.49</td><td></td></tr> <tr><td>475</td><td>270.70</td><td></td></tr> <tr><td>500</td><td>281.92</td><td></td></tr> <tr><td>525</td><td>293.08</td><td></td></tr> <tr><td>550</td><td>304.32</td><td></td></tr> <tr><td>575</td><td>315.51</td><td></td></tr> <tr><td>600</td><td>326.65</td><td></td></tr> </tbody> </table> <p>Prices above are for systems ready-assembled. Substantial savings can be made for self-assembly. Rail can be supplied in full lengths or cut-to-size with accessories separately.</p>	cm	White	£	125	113.80		150	124.97		175	136.24		200	147.34		225	158.64		250	169.82		275	181.05		300	192.27		325	203.44		350	214.66		375	225.89		400	237.09		425	248.23		450	259.49		475	270.70		500	281.92		525	293.08		550	304.32		575	315.51		600	326.65		A	<p><b>Optional Accessories</b> (additional charges may apply)</p> <p>3582 Hook, box 100, outer 1,000, outer 20,000. 3599 Hook, box 100, outer, 25,000. 3603 Top fix bracket, white, at 600mm centres, outer of 100. 3151 Clearance spacer (for top boards). 3620 Connecting bridge, each. 3655 Long universal bracket. 3660 Extra long universal bracket, each. 3914 Bracket for return profile, each. 3916 Pilot runner for multi stack system. 3929 Intermediate pulley, white, each 10. 3932 Spring stop, each 10. 3935 Straight overlap arm, each, 10. 3639 Hanger assembly complete, each.</p> <p><b>Smart Fix Brackets in white, black or silver</b> 11118 Smart Fix 60mm Bracket (11200 Set). 11119 Smart Fix 80mm Bracket (11201 Set). 11120 Smart Fix 100mm Bracket (11202 Set). 11121 Smart Fix 120mm Bracket (11203 Set). 11122 Smart Fix 150mm Bracket (11204 Set). 11123 Smart Fix 200mm Bracket (11205 Set).</p> <p><b>Square Smart Fix Brackets in white, black or silver</b> 11139 Smart Fix 60mm Bracket (11210 Set). 11140 Smart Fix 80mm Bracket (11211 Set). 11141 Smart Fix 100mm Bracket (11212 Set). 11142 Smart Fix 120mm Bracket (11213 Set). 11143 Smart Fix 150mm Bracket (11214 Set). 11144 Smart Fix 200mm Bracket (11215 Set).</p> <p><b>Smart Fix Bracket Covers</b> 11116 Smart Fix Bracket Cover. 11137 Square Smart Fix Bracket Cover.</p> <p><b>Universal Smart Fix Extension Bracket</b> 11154 Universal Smart Fix 120mm. 11155 Universal Smart Fix 150mm. 11156 Universal Smart Fix 200mm.</p>	A
cm	White	£																																																																
125	113.80																																																																	
150	124.97																																																																	
175	136.24																																																																	
200	147.34																																																																	
225	158.64																																																																	
250	169.82																																																																	
275	181.05																																																																	
300	192.27																																																																	
325	203.44																																																																	
350	214.66																																																																	
375	225.89																																																																	
400	237.09																																																																	
425	248.23																																																																	
450	259.49																																																																	
475	270.70																																																																	
500	281.92																																																																	
525	293.08																																																																	
550	304.32																																																																	
575	315.51																																																																	
600	326.65																																																																	
<p><b>Rail &amp; Standard Accessories</b></p> <p>18R Screw 25mm/1" No. 8 round head, 100. 3982W White rail, available in 5m or 6m lengths, in outers of 10 lengths only. 3630 Universal nylon bracket, white, at 600mm centres, 100. 3090 Cord, 100 metres, 500 metres. 3915 Endpiece set, incl. pilot runners 3939/3917, white, outer of 20 or 50 only. 3922 Roller glider in strip form at 10 per metre, outer of 1,000 gliders, outer of 6,000 gliders. 3936 Overlap arm, outer of 20 only.</p>	A	<p><b>Tools</b> 7103 Portable hand operated bending tool. 7109 Portable electrically operated bending tool. 0545 Bending kit for 7103/7109 including filler set, blocks, arms and rings. 80018 Slotting tool. 7803 Filler set for 7103/7109, 200cm. 0540 Bending tool for gradual curves.</p>	E																																																															
<p>10731 Cord retainer</p>	E	<p><b>Bending</b></p> <table border="1"> <thead> <tr> <th></th> <th>Max. trade discount</th> </tr> </thead> <tbody> <tr> <td>Angle bend £60.50 each. Standard radius 20cm. Gradual curve £81.50 each.</td> <td>33 1/3%</td> </tr> </tbody> </table>		Max. trade discount	Angle bend £60.50 each. Standard radius 20cm. Gradual curve £81.50 each.	33 1/3%																																																												
	Max. trade discount																																																																	
Angle bend £60.50 each. Standard radius 20cm. Gradual curve £81.50 each.	33 1/3%																																																																	

All prices shown exclude VAT



# Cord Operated Curtain Track Systems

## SG 3970

Supplied in white. Profile available in 6 metre lengths. Top as standard. Optional recess profile available.

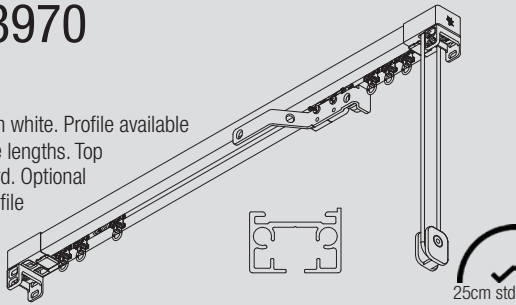

## SG 6370

Supplied in satin silver finish as standard. Profile available in 5 and 6 metre lengths.

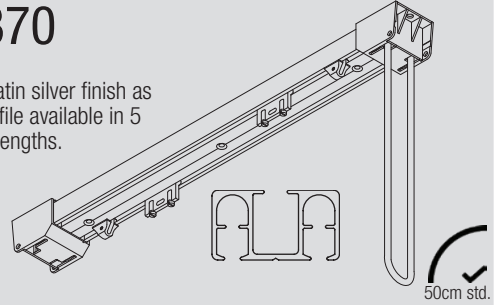

System Prices				Price Ctg.
Specific lengths charged at the nearest 25cm increment above.				C
White	Wave	Wave		
Standard	Roller	Roller		
Roller	Glider	Glider		
Gliders	60mm	80mm		
cm	£	£	£	
125	257.08	298.31	288.07	
150	276.42	333.75	319.95	
175	302.26	371.11	353.88	
200	321.61	406.56	385.77	
225	347.46	443.93	419.70	
250	366.81	479.38	451.59	
275	392.66	516.75	485.52	
300	412.01	552.20	517.40	
325	437.85	589.57	551.33	
350	457.21	625.01	583.22	
375	483.05	662.38	617.15	
400	502.40	697.83	649.04	
425	528.25	735.20	682.97	
450	547.60	770.65	714.85	
475	573.45	808.02	748.78	
500	592.80	843.46	780.67	
525	618.65	880.83	814.60	
550	638.00	916.28	846.51	
575	663.84	953.65	880.43	
600	683.22	989.12	912.33	

Prices above are for systems ready-assembled. Substantial savings can be made for self-assembly. Rail can be supplied in full lengths or cut-to-size with accessories separately.

Rail & Standard Accessories		Price Ctg.
		A
3004	Clamp, each, 10, 100.	
3090	Cord 100, metres, 500 metres.	
10854	Wave overlap support arm, white.	
11295	Endstop, white.	

Rail and Standard Accessories		Price Ctg.
		C
3971	Profile, white 6m.	
10821	Overlap arm, bent, white.	
10826	Overlap arm support set.	
10840	2C Roller glider, at 10 per m, outer 10, 100.	
10852	Wave roller glider cord (80mm pitch), 6.5mm channel.	
10887	Wave overlap arm set.	
10869	Wave roller glider cord (60mm pitch), 6.5mm channel.	
10845	Wave master carrier, single stack 80mm.	
10923	Pan head screw M4X12.	
11314	Master carrier.	
11315	Guide set, white.	

Tools		Price Ctg.
		E
7246	Notching tool for recess profile 10862	

Bending		Price Ctg.
		E
10731	Cord retainer	

All prices shown exclude VAT

Optional Accessories			Price Ctg.
(additional charges may apply)			A
3041	Bracket, each, 100.		
3582	Curtain hook, box, 100.		
	Self-service sachets, 25 x 25.		
	Outer, 20,000.		
6349	Wave® curtain tape.		
6363	Iron-on hemming tape.		
6365	Hanger.		
7002	Profile protector.		
10075	Lead weight 50 gr/m.		
10076	Fabric weight.		
10867	M4 x 16 screw.		
	Smart Fix Brackets in white, black or silver		
11118	Smart Fix 60mm Bracket (11200 Set).		
11119	Smart Fix 80mm Bracket (11201 Set).		
11120	Smart Fix 100mm Bracket (11202 Set).		
11121	Smart Fix 120mm Bracket (11203 Set).		
11122	Smart Fix 150mm Bracket (11204 Set).		
11123	Smart Fix 200mm Bracket (11205 Set).		
	Square Smart Fix Brackets in white, black or silver		
11139	Smart Fix 60mm Bracket (11210 Set).		
11140	Smart Fix 80mm Bracket (11211 Set).		
11141	Smart Fix 100mm Bracket (11212 Set).		
11142	Smart Fix 120mm Bracket (11213 Set).		
11143	Smart Fix 150mm Bracket (11214 Set).		
11144	Smart Fix 200mm Bracket (11215 Set).		
	Smart Fix Bracket Covers		
11116	Smart Fix Bracket Cover.		
11137	Square Smart Fix Bracket Cover.		
	Universal Smart Fix Extension Bracket		
11154	Universal Smart Fix 120mm.		
11155	Universal Smart Fix 150mm.		
11156	Universal Smart Fix 200mm.		

Recess Profile White and Accessories		Price Ctg.
Charged at the nearest 25cm increment above.		C
5118	Wedge for recess profile.	
10820	Overlap arm, straight, white.	
10831	Connecting bridge.	
10862	Recess profile, white, per metre.	
10864	Recess mask, belt return, white.	
10865	Mounting support plate.	

Tools			Price Ctg.
			E
7246	Notching tool for recess profile 10862		

Bending		Price Ctg.
		E
For each bend add the following to above system price:		
Radius/cm		
25-99	£182.00 each.	
Standard radius 25cm		
Over 99	£342.00 each.	

Note: If using recess profile add an additional 20% to the relevant bending charge above. Please note: Standard radius for 3970 is 25cm. Standard minimum radius with recess profile is 50cm

System Prices			Price Ctg.
Specific lengths charged at the nearest 25cm increment above.			C
Satin Silver			
cm		£	
300		458.06	
350		506.71	
400		555.43	
450		604.10	
500		652.77	
550		701.47	
600		750.17	
650		798.87	
700		847.51	
750		896.22	
800		944.85	
850		993.56	
900		1042.25	
950		1090.95	
1000		1139.63	
1050		1188.32	
1100		1236.99	
1150		1285.62	
1200		1334.37	
1250		1383.01	
1300		1431.72	
1350		1480.37	
1400		1529.11	
1450		1577.76	
1500		1626.43	

Connecting bridge included over 6m. Right hand pull as standard.

Above prices are for systems ready-assembled. Substantial savings can be made for self-assembly. Rail can be supplied in full lengths or cut-to-size with accessories separately.

Rail and Standard Accessories		Price Ctg.
		C
6070	Cord.	
6214	Adjustable pilot runner.	
6227	Master pilot runner.	
6371	Silver rail available in 5m and 6m or cut-to-size	
6377	End piece set.	
28C	Screw countersunk, No. 8 2"/50mm.	

Bending		Price Ctg.
		A
6086	Spring stop.	
6098	Roller glider with eye. 10 per metre.	

Tools		Price Ctg.
		E
10731	Cord retainer	

Special Lengths charged at the nearest 50cm increment above.

Optional Accessories			Price Ctg.
(additional charges may apply)			C
6079	Overlap arm.		
6376	Connecting bridge.		

Nylon hook.		Price Ctg.
		A
3599	Nylon hook.	
6283	Roller glider.	
6369	Insert (Face Fix).	

Universal Smart Fix Extension Bracket in white or silver

11154 Universal Smart Fix 120mm.  
11155 Universal Smart Fix 150mm.  
11156 Universal Smart Fix 200mm.

Colours		Price Ctg.
Other colours special order - see Page 73.		E

Bending		Price Ctg.
		E

Standard right angle £155.00 each.  
Standard radius 50cm.  
Semi-circle or gradual curve £458.50 each.



# Metropole

## SG 7600

A decorative curtain pole concept combining beautifully crafted design details with contemporary finishes on our pole systems 7600/7610/7620/7630/7640 and 7650.

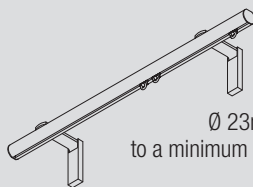

Hand operated,  
Ø 23mm, can be bent  
to a minimum radius of 15cm.

Assembled systems below includes Smart Fix Set 11206 as standard.  
All bent poles are supplied with Smart Fix Set 11209 as standard.  
For additional bracket options please see page 22.



Metropole by Silent Gliss is based around our pole systems 7600/7610/7620 (hand drawn), 7630/7640 (cord drawn) and 7650 (electric).  
Select desired pole combination from our pole catalogue and find price below.

### SG 7600 (SG 1003) HAND DRAWN Ø 23mm – 'SILVER'/'BLACK'/'WHITE'/'MATT WHITE'/'ECRU

Price Category A

Size cm	125	150	175	200	225	250	275	300	325	350	375	400	425	450	475	500	525	550	575	600
Endcap Flush/Stud	106.66	125.21	143.80	162.41	180.94	199.56	218.15	236.74	255.30	273.92	292.52	311.04	329.69	348.23	366.83	385.40	403.98	422.59	441.20	459.78
*Ball End	204.22	222.77	241.35	259.97	278.51	297.11	315.72	334.30	352.85	371.49	390.07	408.59	427.25	445.79	464.40	482.96	501.54	520.16	538.76	557.33
*Spear Finial	172.13	190.69	209.28	227.88	246.43	265.04	283.63	302.22	320.77	339.41	357.99	376.52	395.18	413.72	432.31	450.88	469.46	488.07	506.68	525.26
*Groove Cylinder	168.20	186.75	205.34	223.95	242.49	261.11	279.70	298.28	316.84	335.47	354.06	372.59	391.24	409.78	428.38	446.94	465.53	484.14	502.74	521.32
*Design End Cap	140.34	158.89	177.47	196.09	213.47	233.23	251.84	270.42	288.97	307.60	326.19	344.71	363.37	381.91	400.44	419.08	437.66	456.27	474.88	493.45
*Clear Ball	238.71	257.26	275.85	294.46	313.01	331.60	350.21	368.79	387.34	405.98	424.56	443.09	461.75	480.28	498.91	517.46	536.05	554.64	573.25	591.82
*Ellipse	151.15	169.70	188.28	206.90	225.44	244.04	262.64	281.22	299.77	318.41	337.00	355.53	374.18	392.72	411.31	429.88	448.47	467.08	485.69	504.26
*Taper	137.58	156.13	174.72	193.32	211.86	230.48	249.07	267.67	286.22	304.84	323.43	341.96	360.62	379.16	397.76	416.32	434.91	453.51	472.13	490.70

### SG 7600 (SG 1003) HAND DRAWN Ø 23mm – GUNMETAL/CHARCOAL/'CHROME EFFECT

Size cm	125	150	175	200	225	250	275	300	325	350	375	400	425	450	475	500	525	550	575	600
Endcap Flush/Stud	123.78	147.17	170.45	193.76	217.04	240.38	263.70	286.96	310.24	333.57	356.84	380.20	403.49	426.86	450.14	473.45	496.75	520.07	543.36	566.71
*Ball End	221.34	244.73	268.01	291.31	314.60	337.94	361.26	384.52	407.80	431.13	454.41	477.78	501.06	524.42	547.70	571.00	594.31	617.63	640.92	664.28
*Spear Finial	189.25	212.64	235.93	259.24	282.53	305.87	329.19	352.44	375.72	399.05	422.33	445.69	468.97	492.35	483.81	538.93	562.24	585.56	608.83	632.19
*Groove Cylinder	185.32	208.71	232.00	255.31	278.58	301.92	325.24	348.50	371.79	395.11	418.39	441.76	465.05	488.41	511.68	534.99	558.29	581.61	604.90	628.26
*Design End Cap	157.44	180.85	204.13	227.43	250.72	274.06	308.20	320.63	343.92	367.25	390.52	413.90	437.18	460.54	483.81	507.12	530.43	553.75	577.04	600.39
*Clear Ball	255.82	279.21	302.49	325.82	349.11	372.44	395.76	419.01	442.30	465.63	488.91	512.27	535.56	558.92	582.19	605.49	628.80	652.12	675.41	698.76
*Ellipse	168.26	191.65	214.93	224.68	247.97	284.88	308.20	331.43	354.72	378.06	401.34	424.70	447.99	471.35	494.62	517.93	541.23	564.56	587.85	611.20
*Taper	154.70	178.09	201.38	224.68	247.97	271.31	294.62	317.88	341.17	364.50	387.76	411.13	434.41	457.78	481.06	504.37	527.68	551.00	574.28	597.63

The above pricing includes standard glider (11301). For alternatives add the relevant price supplement below.

### SG 7600 (SG 1003) GLIDER-SUPPLEMENTS

Size cm	125	150	175	200	225	250	275	300	325	350	375	400	425	450	475	500	525	550	575	600
<b>Wave™ Standard Supplement</b>																				
60mm Glider-cord	25.30	30.34	35.41	40.47	45.52	50.59	55.63	60.70	65.74	70.81	75.88	80.92	85.99	91.04	96.10	101.15	106.22	111.28	116.33	121.40
80mm Glider-cord	20.70	25.08	28.87	32.64	37.04	40.80	45.18	48.97	52.73	57.13	60.90	64.67	69.06	72.83	77.23	81.00	84.79	89.16	92.93	96.71
<b>Enhanced Wave Supplement (with added optional extra</b>																				
<b>Please add the following to the above 80mm prices)</b>																				
<b>Option 1: 2256 Adjustable Brake</b>					<b>Option 2: 2255 Adjustable Brake &amp; 6366 Carrier</b>					<b>Option 3: Enhanced Wave (80mm only)</b>										
Single Stack: £9.66		Pair Stack: 19.31		Single Stack: £19.62		Pair Stack: £39.22			Single Stack: £36.40			Pair Stack: £72.83								

Bending (Max. trade discount 331/3%) Angle bend: £ 39.50 each. Standard radius 15cm. Semi-circle or gradual curve: £62.50 each. All bent poles are supplied with Smart Fix extension bracket set 11209.

\* Finials not available in chrome effect or silver

\*\* When a Metropole is ordered in black, the standard glider will also be supplied in black

All prices shown exclude VAT





# Metropole

## SG 7610

A decorative curtain pole concept combining beautifully crafted design details with contemporary finishes on our pole systems 7600/7610/7620/7630/7640 and 7650.

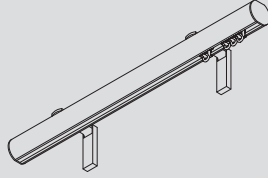

Hand operated, Ø 30mm can be bent to a minimum radius of 25cm

Assembled systems below includes Smart Fix Set 11206 as standard. All bent poles are supplied with Smart Fix Set 11209 as standard. For additional bracket options please see page 22.



### SG 7610 (SG 6130) HAND DRAWN Ø 30mm – \*SILVER\*/BLACK/WHITE/MATT WHITE/ECRU

Price Category A

Size (cm)	125	150	175	200	225	250	275	300	325	350	375	400	425	450	475	500	525	550	575	600
Endcaps Flush/Stud	134.13	153.37	172.49	191.65	210.87	230.06	249.15	268.34	287.42	306.66	316.02	344.93	364.08	383.24	402.41	421.56	440.68	459.85	479.00	498.19
*Ball End	240.00	259.24	278.37	297.54	316.76	335.92	355.02	374.20	393.28	412.54	421.90	450.79	469.95	489.13	508.28	527.42	546.52	565.73	584.88	604.07
*Spear Finial	237.40	256.61	275.79	294.93	314.15	333.32	352.40	371.60	390.70	409.94	419.30	448.19	467.34	486.52	505.70	524.84	543.92	563.15	582.30	601.47
*Groove Cylinder	209.39	228.61	247.74	266.90	286.11	305.31	324.40	343.58	362.66	381.91	391.28	420.17	439.33	458.49	477.66	496.80	515.92	535.11	554.26	573.43
*Design Endcap	180.58	199.82	218.96	238.14	257.34	276.52	295.61	314.78	333.87	353.15	362.49	391.37	410.53	429.70	448.86	468.01	487.12	506.31	525.48	544.65
*Clear Ball	274.27	293.51	312.66	331.79	351.02	370.19	389.28	408.48	427.57	446.83	456.19	485.06	504.23	523.37	542.56	561.70	580.80	600.01	619.17	638.33
*Ellipse	196.83	216.06	235.20	254.36	273.57	292.77	311.85	331.03	350.12	369.37	378.73	407.62	426.78	445.95	465.12	484.25	503.37	522.56	541.71	560.89
*Taper	169.27	188.5	207.63	226.79	246.01	265.19	284.28	303.47	322.55	341.8	351.17	380.06	399.22	418.38	437.55	456.69	475.81	494.99	514.16	533.32

### SG 7610 (SG 6130) HAND DRAWN Ø 30mm – \*CHROME EFFECT (max 4m length)/GUNMETAL/BRONZE/ANTIQU BRONZE/SAND/TAUPE ANODIC GREY/CHARCOAL/SLATE GREY/OCHRE

Size (cm)	125	150	175	200	225	250	275	300	325	350	375	400	425	450	475	500	525	550	575	600
Endcaps Flush/Stud	163.45	188.47	213.56	238.48	263.52	288.53	313.54	338.52	363.61	388.61	413.58	438.65	463.68	488.61	513.73	538.68	563.68	588.67	613.70	638.74
*Ball End	269.32	294.34	319.42	344.34	369.39	394.42	419.41	444.38	469.48	494.47	519.45	544.52	569.56	594.49	619.61	644.56	669.55	694.54	719.56	744.61
*Spear Finial	266.73	291.75	316.83	341.75	366.79	391.80	416.82	441.78	466.90	491.87	516.85	541.93	566.95	591.90	617.01	641.97	666.96	691.93	716.96	742.00
*Groove Cylinder	238.71	263.71	288.80	313.72	338.77	363.78	388.79	413.77	438.86	463.85	488.82	513.89	538.93	563.86	589.00	613.93	638.92	663.92	688.95	714.00
*Design Endcap	209.93	234.92	260.02	284.94	309.99	334.99	359.97	384.99	410.07	435.07	460.03	485.11	510.15	535.06	560.20	585.16	610.14	635.12	660.14	685.21
*Clear Ball	303.62	328.61	353.70	378.64	403.68	428.68	453.67	478.68	503.76	528.75	553.73	578.80	603.84	628.75	653.89	678.84	703.82	728.82	753.83	778.90
*Ellipse	226.17	251.17	276.26	301.17	326.22	351.23	376.25	401.23	426.32	451.30	476.27	501.34	526.38	551.32	576.45	601.39	626.37	651.37	676.40	701.45
*Taper	198.59	223.60	248.69	273.62	298.65	323.67	348.68	373.65	398.74	423.74	448.71	473.78	498.81	523.74	548.88	573.81	598.82	623.80	648.84	673.88

The above pricing includes standard glider (11301). For alternatives add the relevant price supplement below.

### SG 7610 (SG 6130) GLIDER-SUPPLEMENTS

Size cm	125	150	175	200	225	250	275	300	325	350	375	400	425	450	475	500	525	550	575	600
SG 6283 Roller-Glider	24.23	29.07	33.92	38.76	43.61	48.45	53.30	58.15	62.99	67.84	72.68	77.53	82.37	87.22	92.06	96.91	101.75	106.60	111.44	116.30
Supplement																				
Wave™ Standard Supplement																				
60mm Glider-cord	25.30	30.34	35.40	40.47	45.52	50.58	55.63	60.70	65.74	70.81	75.88	80.92	85.99	91.03	96.10	101.15	106.21	111.28	116.33	121.40
80mm Glider-cord	20.70	25.08	28.87	32.64	37.03	40.80	45.18	48.97	52.73	57.13	60.90	64.66	69.06	72.83	77.23	80.99	84.78	89.16	92.93	96.71
Enhanced Wave Supplement (with added optional extras)																				
Please add the following to the above 80mm wave prices.																				
Option 1: 2256 Adjustable Brake																				
Single Stack: £9.66																				
Pair Stack: £ 19.31																				
Option 2: 2255 Adjustable Brake & 6366 Carrier																				
Single Stack: £19.62																				
Pair Stack: £39.22																				
Option 3: Enhanced Wave (80mm only)																				
Single Stack: £36.40																				
Pair Stack: £72.83																				
SG 6099 Wave Roller-Glider																				
Supplement (80mm)	92.42	110.90	129.40	147.88	166.36	184.85	203.33	221.82	240.30	259.05	277.28	295.75	314.23	332.73	351.21	369.70	388.18	406.66	425.15	443.63

Internal connecting bridge 6635 £25.36 each.

Bending 7610 (Max trade discount 33¼%). Angle bend £89.50 each. Standard radius 25cm. Semi circle or gradual curve £121.50 each.

All bent poles are supplied with Smart Fix extension bracket set 11209.

\* Finials are not available in chrome effect or silver

\*\* When a Metropole is ordered in black, the standard glider will also be supplied in black

All prices shown exclude VAT

# Metropole

## SG 7620

A decorative curtain pole concept combining beautifully crafted design details with contemporary finishes on our pole systems 7600/7610/7620/7630/7640 and 7650.

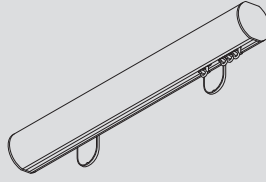

Assembled systems below includes Smart Fix Set \*11206 as standard. All bent poles are supplied with Smart Fix Set 11209 as standard. For additional bracket options please see page 22.

Hand operated, Ø 50mm can be bent to a minimum radius of 50cm



### SG 7620 (SG 6140) HAND DRAWN Ø 50mm – \*\*SILVER/\*\*BLACK/WHITE/MATT WHITE/ECRU

Price Category A

Size (cm)	125	150	175	200	225	250	275	300	325	350	375	400	425	450	475	500	525	550	575	600
Endcap Flush/Stud	164.49	176.22	207.81	239.39	251.13	282.68	294.45	326.01	357.59	369.31	400.87	432.48	444.25	475.79	487.54	519.08	550.68	562.37	594.50	625.55
**Ball End	373.82	385.53	417.13	448.70	460.46	492.00	503.76	535.33	566.91	578.63	610.20	641.79	653.56	685.11	696.87	728.40	760.00	771.70	803.83	834.88
**Spear Finial	470.57	482.31	513.90	545.46	557.22	588.77	600.54	632.10	663.68	675.40	706.96	738.57	750.34	781.87	793.64	825.17	856.78	868.46	900.58	931.65
**Groove Cylinder	326.49	338.22	369.82	401.38	413.13	444.69	456.45	488.01	519.59	531.31	562.87	594.48	606.25	637.79	649.55	681.08	712.69	724.38	756.50	787.56
**Design Endcap	230.41	242.14	273.74	305.30	317.05	348.61	360.36	391.93	423.51	423.83	466.79	498.40	510.17	541.71	553.47	585.00	616.60	628.30	660.41	691.48
**Clear Ball	430.08	441.83	473.43	505.02	516.74	548.30	560.05	591.64	623.19	634.93	666.49	698.10	709.86	741.41	753.16	784.70	816.30	828.01	860.13	891.19
*/**Ellipse	412.52	424.25	455.84	487.41	499.17	530.71	542.49	574.05	605.63	617.35	648.91	680.52	692.29	723.83	735.59	767.12	798.73	810.41	842.53	873.60
*/**Taper	331.29	343.02	374.62	406.20	417.94	449.49	461.25	492.82	524.39	536.11	567.68	599.28	611.06	642.60	654.35	685.88	717.49	729.18	761.30	792.36

### SG 7620 (SG 6140) HAND DRAWN Ø 50mm – TAUPE/ANTIQU BRONZE/ANODIC GREY/SLATE GREY/BRONZE

Size (cm)	125	150	175	200	225	250	275	300	325	350	375	400	425	450	475	500	525	550	575	600
Endcap Flush/Stud	275.65	297.52	338.95	380.54	402.30	443.89	465.65	507.24	548.79	570.53	612.12	653.69	675.50	717.10	738.82	780.42	821.94	843.77	885.34	926.88
Ball End	484.95	506.85	548.26	589.85	611.62	653.21	674.99	716.56	758.12	779.87	821.42	863.01	884.81	926.43	948.14	989.75	1031.26	1053.09	1094.65	1136.23
Spear Finial	581.72	603.61	645.03	686.63	708.39	749.96	771.74	813.33	854.88	876.62	918.20	959.79	981.58	1023.20	1044.91	1086.51	1128.03	1149.85	1191.41	1232.98
Groove Cylinder	437.63	459.53	500.95	542.54	564.30	605.87	627.66	669.24	710.80	732.54	774.11	815.70	837.50	879.11	900.83	942.42	983.94	1005.77	1047.33	1088.89
Design Endcap	341.56	363.45	404.86	446.46	468.22	509.80	531.58	573.16	614.72	636.46	678.03	719.63	741.42	783.02	804.75	846.34	887.86	909.69	951.25	992.81
Clear Ball	541.26	563.14	604.56	646.15	667.92	709.50	731.28	772.86	814.41	836.15	877.74	919.32	941.11	982.71	1004.43	1046.04	1087.57	1109.39	1150.95	1192.51
*Ellipse	523.68	545.56	586.98	628.58	650.34	691.92	713.69	755.27	796.82	807.16	860.15	901.73	923.53	965.15	986.86	1028.46	1069.98	1091.80	1133.36	1174.91
*Taper	442.44	464.33	505.76	547.34	569.10	610.69	632.46	674.05	715.60	737.34	778.93	820.50	842.30	883.91	905.63	947.23	988.75	1010.57	1052.15	1093.69

The above pricing includes standard glider (11301). For alternatives add the relevant price supplement below.

### SG 7620 (SG 6140) GLIDER – SUPPLEMENTS

Size (cm)	125	150	175	200	225	250	275	300	325	350	375	400	425	450	475	500	525	550	575	600
SG 6283 Roller-Glider	24.23	29.07	33.92	38.76	43.61	48.45	53.30	58.15	62.99	67.84	72.68	77.53	82.37	87.22	92.06	96.91	101.75	106.60	111.44	116.30
Supplement																				
Wave®Standard Supplement																				
60mm Glider-cord	25.30	30.34	35.40	40.47	45.52	50.58	55.63	60.70	65.74	70.81	75.88	80.92	85.99	91.03	96.10	101.15	106.21	111.28	116.33	121.40
80mm Glider-cord	20.70	25.08	28.87	32.64	37.03	40.80	45.18	48.97	52.73	57.13	60.90	64.66	69.06	72.83	77.23	80.99	84.78	89.16	92.93	96.71
Enhanced Wave Supplement																				
Please add the following to the above 80mm wave prices.																				
Option 1: 2256 Adjustable Brake							Option 2: 2255 Adjustable Brake & 6366 Carrier							Option 3: Enhanced Wave (80mm only)						
Single Stack: £9.66			Pair Stack: £19.31				Single Stack: £19.62			Pair Stack: £39.22				Single Stack: £36.40			Pair Stack: £72.83			
SG 6099 Wave Roller-Glider (Not for use on bent 50mm poles)																				
Supplement (80mm)*	92.42	110.90	129.40	147.88	166.36	184.85	203.33	221.82	240.30	259.05	277.28	295.75	314.23	332.73	351.21	369.70	388.18	406.66	425.15	443.63

7620 Connecting Bridge, 11783 see parts list for prices.

Bending (Max. trade discount 33 1/3%) Angle bend: £99.00 each. Standard radius 50cm. Semi-circle or gradual curve: £132.50 each.

Bent tracks not compatible with 6099 Wave Roller Glider.

All bent poles are supplied with Smart Fix extension bracket set 11209.

\*Ellipse finials on 50mm poles can only be face fixed, standard bracket supplied with Ellipse or Taper finials are 11207.

\*\* Finials are not available in silver

\*\*\* When a Metropole is ordered in black, the standard glider will also be supplied in black

All prices shown exclude VAT



# Metropole

## SG 7630

A decorative curtain pole concept combining beautifully crafted design details with contemporary finishes on our pole systems 7600/7610/7620/7630 /7640 and 7560.

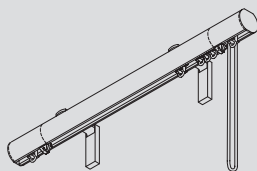

Cord operated, Ø 30mm can be bent to a minimum radius of 30cm

Assembled systems below includes Smart Fix Set 11206 as standard.  
All bent poles are supplied with Smart Fix Set 11209 as standard.  
For additional bracket options please see page 22.

All bent poles are supplied with adjustable brackets.



### SG 7630 (SG 6120) CORD DRAWN Ø 30mm – BLACK/WHITE/MATT WHITE/ECRU

Price Category A

Size cm	125	150	175	200	225	250	275	300	325	350	375	400	425	450	475	500	525	550	575	600
Flush/Stud Endcap	234.50	259.16	284.00	308.74	333.44	358.26	382.96	407.43	432.51	457.23	481.99	506.74	531.50	556.23	581.00	605.74	630.48	655.22	680.00	704.74
Ball End	340.33	365.02	389.86	414.59	439.31	464.14	488.82	513.30	538.39	563.10	587.85	612.61	637.36	662.10	686.88	711.62	736.36	761.10	785.88	810.62
Spear Finial	337.75	362.44	387.27	412.00	436.71	461.52	486.23	510.72	535.78	560.50	585.24	609.99	634.77	659.50	684.26	709.00	733.73	758.47	783.26	808.00
Groove Cylinder	309.74	334.41	359.25	383.98	408.69	433.52	458.22	482.68	507.75	532.48	557.23	581.98	606.74	631.47	656.24	680.99	705.73	730.47	755.26	779.98
Design Endcap	280.95	305.60	330.44	355.17	379.92	404.73	429.43	453.88	478.95	503.68	528.45	553.20	577.95	602.68	627.43	652.20	676.94	701.69	726.45	751.20
Clear Ball	374.63	399.28	424.12	448.87	473.59	498.43	523.12	547.57	572.65	597.39	622.12	646.90	671.66	696.37	721.13	745.87	770.63	795.37	820.16	844.87
Ellipse	297.20	321.86	346.70	371.44	396.15	420.97	445.67	470.13	495.20	519.93	544.68	569.44	594.20	618.93	643.70	668.46	693.18	717.92	742.71	767.43
Taper	269.63	294.29	319.15	343.88	368.59	393.41	418.11	442.56	467.64	492.37	517.12	541.87	566.63	591.36	616.14	640.89	665.62	690.36	715.14	739.87

### SG 7630 (SG 6120) CORD DRAWN Ø 30mm – OCHRE/GUNMETAL/BRONZE/ANTIQU BRONZE/SAND/TAUPE/ANODIC GREY/CHARCOAL/SLATE GREY/CHROME EFFECT (max 4m length)

Size cm	125	150	175	200	225	250	275	300	325	350	375	400	425	450	475	500	525	550	575	600
Flush/Stud Endcap	265.49	296.54	327.46	358.44	389.39	420.39	451.39	482.26	513.25	544.21	575.21	606.18	637.09	668.04	699.12	730.01	760.96	791.94	822.91	853.85
*Ball End	371.37	402.40	433.32	464.31	495.28	526.26	557.25	588.14	619.11	650.08	681.08	712.06	742.96	773.92	804.99	835.88	866.85	897.81	928.78	959.73
*Spear Finial	368.77	399.80	430.73	461.71	492.65	523.66	554.67	585.54	616.52	647.47	678.48	709.45	740.35	771.33	802.39	833.26	864.24	895.21	926.19	957.12
*Groove Cylinder	340.75	371.79	402.70	433.68	464.63	495.65	526.63	557.51	588.49	620.63	650.47	681.43	712.34	743.30	774.37	805.25	836.21	867.19	898.16	929.10
*Design Endcap	311.96	342.99	373.89	404.88	435.83	466.85	497.85	528.72	559.70	590.66	621.67	652.65	683.54	714.50	745.56	776.44	807.43	838.38	869.36	900.30
*Clear Ball	405.64	436.69	467.60	498.59	529.52	560.53	591.53	622.41	653.41	684.37	715.34	746.33	777.22	808.21	839.24	870.13	901.11	932.08	963.05	994.00
*Ellipse	328.21	359.23	390.15	421.14	452.09	483.10	514.08	544.96	575.95	606.92	637.92	668.88	699.79	730.75	761.83	792.71	823.66	854.64	885.61	916.56
*Taper	300.64	331.68	362.59	393.57	424.52	455.53	486.52	517.39	548.38	579.35	610.35	641.31	672.22	703.18	734.26	765.15	796.10	827.07	858.05	888.98

The above pricing includes standard glider (11301). For alternative glider options including wave and roller glider, please add the relevant price supplement below.

### SG 7630 (SG 6120) GLIDER-SUPPLEMENTS

Size cm	125	150	175	200	225	250	275	300	325	350	375	400	425	450	475	500	525	550	575	600
SG 6283 Roller-Glider Supplement	24.23	29.07	33.92	38.76	43.61	48.45	53.30	58.15	62.99	67.84	72.68	77.53	82.37	87.22	92.06	96.91	101.75	106.60	111.44	116.30
Wave™ Standard Supplement																				
60mm Glider-cord	25.30	30.34	35.40	40.47	45.52	50.58	55.63	60.70	65.74	70.81	75.88	80.92	85.99	91.03	96.10	101.15	106.21	111.28	116.33	121.40
80mm Glider-cord	20.70	25.08	28.87	32.64	37.03	40.80	45.18	48.97	52.73	57.13	60.90	64.66	69.06	72.83	77.23	80.99	84.78	89.16	92.93	96.71
Enhanced Wave Supplement (Please add the following to the above 80mm wave prices)																				
Single Stack: £23.09    Pair Stack: £46.22																				
SG 6099 Wave Roller-Glider Supplement (80mm)	92.42	110.90	129.40	147.88	166.36	184.85	203.33	221.82	240.30	259.05	277.28	295.75	314.23	332.73	351.21	369.70	388.18	406.66	425.15	443.63

- Includes 1 x 10731 Cord retainer

Bending (Max. trade discount 33 1/3%) Angle bend: £93.50 each. Standard radius 30cm. Semi-circle or gradual curve: £127.00 each.  
All bent poles are supplied with Smart Fix extension bracket set 11209.

Intermediate pulley 11663, see parts list for prices.

\* Finials are not available in chrome effect

\*\* When a Metropole is ordered in black, the standard glider will also be supplied in black

All prices shown exclude VAT

# Metropole

## SG 7640

A decorative curtain pole concept combining beautifully crafted design details with contemporary finishes on our pole systems 7600/7610/7620/7630/7640 and 7650.

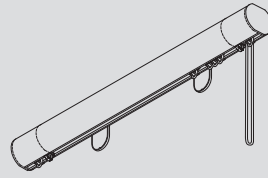

Cord operated, Ø 50mm  
can be bent to a minimum  
radius of 60cm

Assembled systems below includes Smart Fix Set \*11206 as standard.  
All bent poles are supplied with Smart Fix Set 11209 as standard.  
For additional bracket options please see page 22.



### SG 7640 (SG 6160) CORD DRAWN Ø 50mm – \*\*BLACK/WHITE/MATT WHITE/ECRU

Price Category A

Size (cm)	125	150	175	200	225	250	275	300	325	350	375	400	425	450	475	500	525	550	575	600
Endcap Flush/Stud	301.67	316.51	351.12	385.73	400.54	435.19	449.97	484.62	519.23	534.04	568.66	603.29	618.14	652.73	667.55	702.19	736.81	751.61	786.22	820.87
Ball End	510.99	525.82	560.42	595.04	609.86	644.51	659.30	693.95	728.54	743.36	777.96	812.62	827.44	862.04	876.85	911.48	946.12	960.92	995.55	1030.17
Spear Finial	607.75	622.59	657.21	691.82	706.63	741.28	756.06	790.70	825.31	840.12	874.74	909.37	924.21	958.81	973.62	1008.27	1042.90	1057.70	1092.32	1126.96
Groove Cylinder	463.66	478.50	513.12	547.73	562.54	597.19	611.98	646.61	681.23	696.04	730.66	765.30	780.13	814.72	829.54	864.18	898.82	913.62	948.23	982.87
Design Endcap	367.58	382.43	417.04	451.65	466.46	501.11	515.90	550.53	585.15	599.95	634.58	669.21	684.05	718.65	733.46	768.11	802.73	817.55	852.14	886.79
Clear Ball	567.30	582.10	616.74	651.35	666.16	700.82	715.59	750.24	784.85	799.67	834.26	868.92	883.74	918.34	933.16	967.79	1002.44	1017.21	1051.85	1086.47
*Ellipse	549.70	564.54	599.16	633.77	648.58	683.23	698.01	732.08	767.26	782.07	816.69	851.32	866.16	900.76	915.57	950.22	984.85	999.65	1034.27	1068.91
*Taper	468.47	483.30	517.93	552.54	567.35	602.00	616.78	651.42	686.04	700.84	735.47	770.10	784.94	819.52	834.35	868.99	903.62	918.42	953.03	987.67

### SG 7640 (SG 6160) CORD DRAWN Ø 50mm – TAUPE/ANTIQU BRONZE/ANODIC GREY/SLATE GREY/BRONZE

Size (cm)	125	150	175	200	225	250	275	300	325	350	375	400	425	450	475	500	525	550	575	600
Endcap Flush/Stud	393.68	416.28	458.70	501.16	523.80	566.20	588.83	631.30	673.73	696.33	738.76	781.23	803.82	846.24	868.89	911.34	953.72	976.37	1018.83	1061.26
Ball End	602.99	625.60	668.02	710.49	733.12	775.51	798.15	840.62	883.05	905.63	948.09	990.55	1013.12	1055.56	1078.49	1120.65	1163.06	1185.70	1228.13	1270.58
Spear Finial	699.76	722.36	764.77	807.26	829.90	872.29	894.91	937.39	979.81	1002.41	1044.85	1087.31	1109.90	1152.33	1174.98	1217.41	1259.81	1282.45	1324.90	1367.35
Groove Cylinder	555.67	578.27	620.69	663.17	685.81	728.21	750.83	793.65	835.73	858.33	900.76	943.24	965.82	1008.24	1030.89	1073.34	1115.73	1138.37	1180.82	1223.69
Design Endcap	459.59	483.36	524.61	567.08	589.73	632.12	654.76	697.22	739.65	762.25	804.68	847.16	869.74	912.16	934.81	977.26	1019.65	1042.29	1084.74	1127.17
Clear Ball	659.28	681.88	724.29	766.76	789.40	831.79	854.42	896.89	939.31	961.91	1004.35	1046.83	1069.41	1111.84	1134.49	1176.93	1219.32	1241.97	1284.41	1326.85
*Ellipse	641.72	664.32	706.72	749.21	771.85	814.24	836.86	879.34	921.76	944.36	986.80	1029.26	1051.85	1094.28	1116.93	1159.36	1201.76	1224.40	1266.86	1309.30
*Taper	560.49	583.09	625.51	667.97	690.61	733.01	755.63	798.10	840.54	863.12	905.57	948.04	970.63	1013.05	1035.70	1078.15	1120.53	1143.18	1185.63	1228.07

The above pricing includes standard glider (11301). For alternatives add the relevant price supplement below.

### SG 7640 (SG 6160) GLIDER – SUPPLEMENTS

Size	125	150	175	200	225	250	275	300	325	350	375	400	425	450	475	500	525	550	575	600
SG 6283 Roller-Glider	24.23	29.07	33.92	38.76	43.61	48.45	53.30	58.15	62.99	67.84	72.68	77.53	82.37	87.22	92.06	96.91	101.75	106.60	111.44	116.30
Supplement																				
Wave™ Standard Supplement																				
60mm Glider-cord	25.30	30.34	35.40	40.47	45.52	50.58	55.63	60.70	65.74	70.81	75.88	80.92	85.99	91.03	96.10	101.15	106.21	111.28	116.33	121.40
80mm Glider-cord	20.70	25.08	28.87	32.64	37.03	40.80	45.18	48.97	52.73	57.13	60.90	64.66	69.06	72.83	77.23	80.99	84.78	89.16	92.93	96.71
Enhanced Wave Supplement																				
Please add the following to the above 80mm wave prices.																				
Enhanced Wave																				
Single Stack: £23.09																				
Pair Stack: £46.22																				
SG 6099 Wave Roller-Glider (Not for use on bent 50mm poles)																				
Supplement (80mm)*	92.42	110.90	129.40	147.88	166.36	184.85	203.33	221.82	240.30	259.05	277.28	295.75	314.23	332.73	351.21	369.70	388.18	406.66	425.15	443.63

7640 Intermediate Pulley 11664, see parts list for prices.

Bending (Max. trade discount 33 1/3%) Angle bend: £99.00 each. Standard radius 68cm. Semi-circle or gradual curve: £132.50 each.

Bent tracks not compatible with 6099 Wave Roller Glider.

All bent poles are supplied with Smart Fix extension bracket set 11209.

\*Ellipse finials on 50mm poles can only be face fixed, standard brackets supplied with Ellipse or Taper finials are 11207.

\*\*When a Metropole is ordered in black, the standard glider will also be supplied in black

All prices shown exclude VAT









# Metropole

Electric Metropole SG 7650 (SG 6150) System – 5600 Integral Receiver System

Price Category C

Size (cm)	125	150	175	200	225	250	275	300	325	350	375	400	425	450	475	500	525	550	575	600
<b>*Silver/White/**Black/Ecru/Matt White</b>																				
Endcaps Flush/Stud	2241.50	2237.26	2300.63	2317.60	2445.02	2461.97	2494.04	2511.01	2669.69	2665.48	2718.74	2745.72	2863.16	2890.13	2922.24	2939.17	3097.85	3083.58	3147.37	3173.92
*Ball End	2450.81	2446.58	2509.95	2526.91	2654.34	2671.29	2703.36	2720.33	2879.01	2874.80	2928.06	2955.04	3072.47	3099.45	3131.55	3148.49	3307.17	3292.90	3356.69	3383.22
*Spear Finial	2547.58	2543.34	2606.71	2623.68	2751.11	2768.06	2800.13	2817.10	2975.78	2971.57	3024.83	3051.81	3169.24	3196.22	3228.32	3245.26	3403.94	3389.67	3453.46	3479.99
*Groove Cylinder	2403.49	2399.26	2462.63	2479.60	2607.02	2623.97	2656.04	2673.01	2831.69	2827.48	2880.74	2907.72	3025.16	3052.13	3084.24	3101.17	3259.85	3245.58	3309.37	3335.91
*Design Endcap	2307.41	2303.18	2366.55	2383.52	2510.94	2527.89	2559.96	2576.93	2735.61	2731.40	2784.67	2811.64	2929.08	2956.05	2988.16	3005.09	3163.77	3149.50	3213.29	3239.83
*Clear Ball	2507.12	2502.88	2566.25	2583.21	2710.64	2727.59	2759.66	2776.63	2935.31	2931.10	2984.36	3011.34	3128.77	3155.75	3187.85	3204.79	3363.47	3349.20	3412.99	3439.53
**Ellipse	2489.53	2485.29	2548.66	2565.63	2693.06	2710.01	2742.08	2759.05	2917.73	2913.52	2966.78	2993.76	3111.19	3138.17	3170.27	3187.20	3345.88	3331.62	3395.41	3421.95
**Taper	2408.31	2404.06	2467.43	2484.40	2611.83	2628.78	2660.85	2677.82	2836.50	2832.29	2885.55	2912.53	3029.96	3056.94	3089.04	3105.98	3264.66	3250.39	3314.18	3340.73
<b>Anodic Grey/Slate Grey/Antique Bronze/Taupe/Bronze</b>																				
Endcaps Flush/Stud	2288.48	2289.27	2357.65	2379.65	2512.13	2534.11	2571.19	2593.22	2756.91	2757.73	2816.00	2848.02	2970.50	3002.52	3039.62	3061.57	3225.31	3216.06	3284.88	3316.45
Ball End	2497.80	2498.59	2566.97	2588.96	2721.45	2743.43	2780.51	2802.54	2966.23	2967.05	3025.32	3057.34	3179.82	3211.84	3248.94	3270.88	3434.62	3425.38	3494.20	3525.78
Spear Finial	2594.57	2595.35	2663.74	2685.73	2818.22	2840.20	2877.28	2899.30	3063.00	3063.81	3122.09	3154.11	3276.59	3308.61	3345.70	3367.65	3531.39	3522.15	3590.97	3622.53
Groove Cylinder	2450.48	2451.27	2519.65	2541.65	2674.13	2696.11	2733.19	2755.22	2918.91	2919.73	2978.00	3010.02	3132.50	3164.52	3201.62	3223.57	3387.31	3378.06	3446.88	3478.45
Design Endcap	2354.40	2355.19	2423.57	2445.57	2578.05	2600.03	2637.11	2659.14	2822.83	2823.65	2881.92	2913.94	3036.42	3068.44	3105.54	3127.49	3291.23	3281.98	3350.80	3382.38
Clear Ball	2554.11	2554.89	2623.27	2645.26	2777.75	2799.73	2836.81	2858.84	3022.53	3023.35	3081.62	3113.64	3236.12	3268.14	3305.24	3327.19	3490.93	3481.68	3550.50	3582.07
*Ellipse	2536.52	2537.30	2605.69	2627.68	2760.17	2782.14	2819.23	2841.25	3004.95	3005.76	3064.04	3096.06	3218.54	3250.56	3287.65	3309.60	3473.34	3464.10	3532.92	3564.48
Taper	2455.29	2456.07	2524.46	2546.45	2678.94	2700.92	2738.00	2760.02	2923.72	2924.53	2982.81	3014.83	3137.31	3169.33	3206.43	3228.37	3392.11	3382.87	3451.69	3483.26

## Wave Roller Glider – SUPPLEMENT

Size (cm)	125	150	175	200	225	250	275	300	325	350	375	400	425	450	475	500	525	550	575	600
60/80mm	54.74	65.69	76.63	87.57	98.51	109.47	120.41	131.36	142.31	153.25	164.19	175.14	186.08	197.04	207.98	218.92	229.86	240.82	251.76	262.72

\*Ellipse finials on 50mm poles can only be face fixed, standard brackets supplied with Ellipse or Taper finials are 11207.

\*\*Finials not available in silver

\*\*\*When a 7650/5600 Metropole is ordered in black, the standard glider will also be supplied in black

## SG 7605 Metropole

A 36mm deep flat profile

Assembled systems below includes Smart Fix Set **11206** as standard.  
Bent poles are supplied with Smart Fix Set **11209** as standard.  
For additional bracket options, please see page 22.

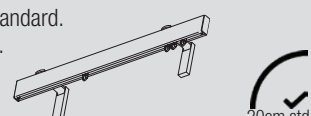

20cm std.

HAND DRAWN 36mm deep – WHITE/SILVER/\*\*BLACK/GUNMETAL/ANTIQUÉ BRONZE/CHROME EFFECT (max. length 3.95m)/

ANODIC GREY/CHARCOAL/SLATE GREY/MATT WHITE/BRONZE

Price Category A

Size (cm)	125	150	175	200	225	250	275	300	325	350	375	400	425	450	475	500	525	550	575	600
<b>Pole 6100 with Flush/Stud endcaps</b>																				
Silver/Black/White/ Matt White	131.87	149.35	166.99	184.59	202.1	219.71	237.26	254.91	272.39	290	307.59	325.16	342.76	360.32	377.91	395.47	413.03	430.6	448.18	465.76
<b>Pole 6100 with Flush/Stud endcaps</b>																				
Slate Grey/Charcoal/ Chrome Effect/Anodic Grey/ Ant Bze Gunmetal/Bronze	158.38	181.27	204.16	227.05	249.95	272.8	295.7	318.56	341.48	364.32	387.21	410.04	433	455.89	478.76	501.62	524.51	547.39	570.29	593.17

The above pricing includes standard glider (11301). For alternatives add the relevant price supplement below.

## SG 7605 (SG 6100) GLIDER - SUPPLEMENTS

Size (cm)	125	150	175	200	225	250	275	300	325	350	375	400	425	450	475	500	525	550	575	600
<b>SG 6283 Roller-Glider Supplement</b>	24.23	29.07	33.92	38.76	43.61	48.45	53.30	58.15	62.99	67.84	72.68	77.53	82.37	87.22	92.06	96.91	101.75	106.60	111.44	116.30
<b>Wave™ Standard Supplement</b>																				
60mm Glider-cord	25.30	30.34	35.40	40.47	45.52	50.58	55.63	60.70	65.74	70.81	75.88	80.92	85.99	91.03	96.10	101.15	106.21	111.28	116.33	121.40
80mm Glider-cord	20.70	25.08	28.87	32.64	37.03	40.80	45.18	48.97	52.73	57.13	60.90	64.66	69.06	72.83	77.23	80.99	84.78	89.16	92.93	96.71
OR																				
<b>Enhanced Wave Supplement (with added optional extras)</b>																				
<b>Please add the following to the above 80mm wave prices.</b>																				
<b>Option 1: 2256 Adjustable Brake</b>						<b>Option 2: 2255 Adjustable Brake &amp; 6366 Carrier</b>						<b>Option 3: Enhanced Wave (80mm only)</b>								
Single Stack: £9.66			Pair Stack: £19.31			Single Stack: £19.62			Pair Stack: £39.22			Single Stack: £36.40			Pair Stack: £72.83					
<b>SG 6099 Wave Roller-Glider Supplement (80mm)</b>																				
	92.42	110.90	129.40	147.88	166.36	184.85	203.33	221.82	240.30	259.05	277.28	295.75	314.23	332.73	351.21	369.70	388.18	406.66	425.15	443.63

Bending 7605 (max trade discount 33.33 %) Angle bend: £38.50 each. Standard radius 20cm.  
Semi-circle or gradual curve: £52.00 each.

\* When a Metropole is ordered in black, the standard glider will also be supplied in black

All prices shown exclude VAT



# Metropole Brackets

	11125 Smart Fix 80mm Bracket (11207 Set)		11668 Top Fix Bracket
	11126 Smart Fix 100mm Bracket (11208 Set)		11669 Fillet Bracket
	11216 Square Smart Fix 60mm Bracket Set		6175 Mini Hanger
	11217 Square Smart Fix 80mm Bracket Set		11154 Universal Smart Fix Set 120mm
	11218 Square Smart Fix 100mm Bracket Set		11155 Universal Smart Fix Set 150mm
	11472 Square Smart Fix Adjustable Bracket Set		11156 Universal Smart Fix Set 200mm

## Brackets

Price Category A

Bracket Supplements – Add the following supplement on to the system price if alternative brackets have been specified:

Pole Size (cm)	No. of Brackets	11125 (11207 Set) Smart Fix 80mm		11126 (11208 Set) Smart Fix 100mm		6175 Mini Hanger		11669 Fillet Bracket		11668 Top Fix Bracket	11154 Universal Smart Fix Bracket	11155 Universal Smart Fix Bracket	11156 Universal Smart Fix Bracket
		Colour		Colour		Colour		Colour		Colour	Colour	Colour	Colour
		Silver, Black, White, Matt White, Ecu, Gunmetal, Charcoal, Bronze, Antique Bronze, Anodic Grey, Slate Grey, Ochre, Sand, Taupe	Chrome Effect	Silver, Black, White, Matt White, Ecu, Gunmetal, Charcoal, Bronze, Antique Bronze, Anodic Grey, Slate Grey, Ochre, Sand, Taupe	Chrome Effect	Silver, White	Black, Gunmetal, Matt White, Charcoal, Ecu, Bronze, Antique Grey, Slate Grey, Ochre, Sand, Taupe	Silver, Black, Gunmetal, White, Matt White, Charcoal, Ecu, Bronze, Antique Grey, Slate Grey, Ochre, Sand, Taupe	Chrome Effect	Silver, Black, Gunmetal, White, Matt White, Charcoal, Ecu, Bronze, Antique Bronze, Anodic Grey, Slate Grey, Ochre, Sand, Taupe	Silver, Black, Gunmetal, White, Matt White, Charcoal, Ecu, Bronze, Antique Bronze, Anodic Grey, Slate Grey, Ochre, Sand, Taupe (Available 1st February 2024)		
125	3	3.62	1.98	7.59	11.14	75.83	108.39	123.97	101.18	40.70	77.92	79.20	80.94
150	4	4.82	2.64	10.12	14.86	101.10	144.52	165.29	134.90	54.26	103.90	105.60	107.91
175	4	4.82	2.64	10.12	14.86	101.10	144.52	165.29	134.90	54.26	103.90	105.60	107.91
200	4	4.82	2.64	10.12	14.86	101.10	144.52	165.29	134.90	54.26	103.90	105.60	107.91
225	5	6.03	3.30	12.65	18.58	126.38	180.65	206.62	168.62	67.83	129.87	132.00	134.89
250	5	6.03	3.30	12.65	18.58	126.38	180.65	206.62	168.62	67.83	129.87	132.00	134.89
275	6	7.24	3.96	15.19	22.29	151.65	216.78	247.94	202.35	81.39	155.84	158.40	161.87
300	6	7.24	3.96	15.19	22.29	151.65	216.78	247.94	202.35	81.39	155.84	158.40	161.87
325	6	7.24	3.96	15.19	22.29	151.65	216.78	247.94	202.35	81.39	155.84	158.40	161.87
350	7	8.44	4.62	17.72	26.01	176.93	252.91	289.27	236.07	94.96	181.82	184.80	188.85
375	7	8.44	4.62	17.72	26.01	176.93	252.91	289.27	236.07	94.96	181.82	184.80	188.85
400	7	8.44	4.62	17.72	26.01	176.93	252.91	289.27	236.07	94.96	181.82	184.80	188.85
425	8	9.65	5.28	20.25	29.72	202.20	289.04	330.59	269.80	108.52	207.79	211.20	215.83
450	8	9.65	5.28	20.25	29.72	202.20	289.04	330.59	269.80	108.52	207.79	211.20	215.83
475	9	10.86	5.94	22.78	33.44	227.48	325.17	371.91	303.52	122.09	233.77	237.60	242.81
500	9	10.86	5.94	22.78	33.44	227.48	325.17	371.91	303.52	122.09	233.77	237.60	242.81
525	9	10.86	5.94	22.78	33.44	227.48	325.17	371.91	303.52	122.09	233.77	237.60	242.81
550	10	12.06	6.60	25.31	37.16	252.75	361.30	413.24	337.25	135.65	259.74	264.00	269.78
575	10	12.06	6.60	25.31	37.16	252.75	361.30	413.24	337.25	135.65	259.74	264.00	269.78
600	10	12.06	6.60	25.31	37.16	252.75	361.30	413.24	337.25	135.65	259.74	264.00	269.78

Pole Size (cm)	No. of Brackets	11216 set (11145+11137) Square Smart Fix 60mm			11217 set (11146+11137) Square Smart Fix 80mm			11218 set (11147+11137) Square Smart Fix 100mm			11472 set (11483+11137) Square Smart Fix Adjustable		
		Colour			Colour			Colour			Colour		
		Silver, White	Black, Matt White, Ecu, Gunmetal, Charcoal, Bronze, Antique Bronze, Anodic Grey, Slate Grey, Ochre, Sand, Taupe	Chrome Effect	Silver, White	Black, Matt White, Ecu, Gunmetal, Charcoal, Bronze, Antique Bronze, Anodic Grey, Slate Grey, Ochre, Sand, Taupe	Chrome Effect	Silver, White	Black, Matt White, Ecu, Gunmetal, Charcoal, Bronze, Antique Bronze, Anodic Grey, Slate Grey, Ochre, Sand, Taupe	Chrome Effect	White, Silver	Black, Matt White, Ecu, Gunmetal, Charcoal, Bronze, Antique Bronze, Anodic Grey, Slate Grey, Ochre, Sand, Taupe	Chrome Effect
125	3	17.73	23.14	34.04	19.51	24.92	35.62	22.01	27.43	37.24	21.47	26.91	58.30
150	4	23.64	30.86	45.40	26.01	33.23	47.50	29.35	36.56	49.65	28.61	35.88	77.73
175	4	23.64	30.86	45.40	26.01	33.23	47.50	29.35	36.56	49.65	28.61	35.88	77.73
200	4	23.64	30.86	45.40	26.01	33.23	47.50	29.35	36.56	49.65	28.61	35.88	77.73
225	5	29.55	38.57	56.74	32.51	41.53	59.37	36.68	45.70	62.06	35.77	44.85	97.16
250	5	29.55	38.57	56.74	32.51	41.53	59.37	36.68	45.70	62.06	35.77	44.85	97.16
275	6	35.46	46.28	68.09	39.01	49.84	71.24	44.02	54.85	74.47	42.92	53.82	97.16
300	6	35.46	46.28	68.09	39.01	49.84	71.24	44.02	54.85	74.47	42.92	53.82	116.59
325	6	35.46	46.28	68.09	39.01	49.84	71.24	44.02	54.85	74.47	42.92	53.82	116.59
350	7	41.37	54.00	79.44	45.52	58.14	83.12	51.36	63.99	86.89	50.07	62.79	136.03
375	7	41.37	54.00	79.44	45.52	58.14	83.12	51.36	63.99	86.89	50.07	62.79	136.03
400	7	41.37	54.00	79.44	45.52	58.14	83.12	51.36	63.99	86.89	50.07	62.79	136.03
425	8	47.28	61.71	90.79	52.02	66.45	94.99	58.70	73.13	99.30	57.23	71.76	136.03
450	8	47.28	61.71	90.79	52.02	66.45	94.99	58.70	73.13	99.30	57.23	71.76	155.46
475	9	53.19	69.43	102.14	58.52	74.76	106.86	66.03	82.27	111.71	64.38	80.73	155.46
500	9	53.19	69.43	102.14	58.52	74.76	106.86	66.03	82.27	111.71	64.38	80.73	174.89
525	9	53.19	69.43	102.14	58.52	74.76	106.86	66.03	82.27	111.71	64.38	80.73	174.89
550	10	59.10	77.14	113.49	65.02	83.06	118.74	73.37	91.41	124.12	71.53	89.70	174.89
575	10	59.10	77.14	113.49	65.02	83.06	118.74	73.37	91.41	124.12	71.53	89.70	194.32
600	10	59.10	77.14	113.49	65.02	83.06	118.74	73.37	91.41	124.12	71.53	89.70	194.32

\*Smart Fix bracket sets, 11207 and 11208 are supplied as standard at no additional charge for WAVE.

\*\*Universal Smart Fix bracket options above are for single Metropole fixing. If double Metropole fixing is required please contact Silent Gliss for pricing. 11154 not suitable for double pole fixing.

Ellipse finials on 50mm poles can only be face fixed.

Extension brackets can be coloured to suit Metropole (refer to page 73 for pricing).

All prices shown exclude VAT





# Room Divider / Cubicle Track Systems

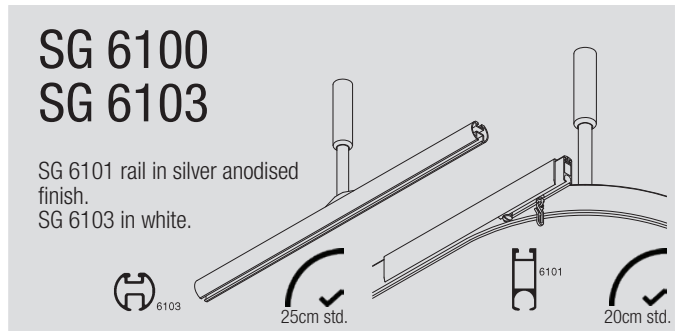

				Price Ctgy.
Ready, complete, pre-packed with all accessories, including hanger rod(s) where applicable.				A
<b>System Prices</b>				
		<b>6100 Silver</b>	<b>6103 White</b>	
<b>Model A</b>	91cm 183cm 213cm 244cm	64.96 102.28 115.44 131.20	111.21 162.02 178.63 195.66	
<b>Model B</b>	76cmx76cm 91cmx91cm	135.93 148.84	204.03 220.76	
<b>Model C-left Model D-right</b>	168cmx76cm	173.33	254.88	
<b>Model E</b>	91cmx76cm x91cm	243.31	310.59	
Special shapes for Shower Rails Send template and drawings for quotation.				A

<b>Colours</b> Special order – see Page 73.	E
--	---

<b>Bending for special shower rails</b>	
<b>Max. trade discount</b>	33 1/3%
6101 Angle bend £28.00 Standard radius 20cm. Semi-circle or gradual curve £38.50 6103 Angle bend £69.50 Standard radius 25cm Semi-circle or gradual curve £92.00	

All prices shown  
exclude VAT



# Room Divider / Cubicle Track Systems

Hospital Cubicle System available through approved Distributors only.

## SG 6100

Hospital Cubicle Safety Device System available through approved Distributors only – use in conjunction with System 6100

## SG 6650

## SG 6103

Supplied in satin silver finish and white in 6 metre lengths.

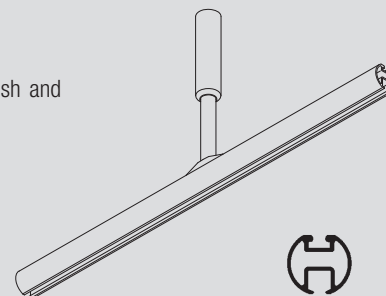

	Price Ctg.
<b>Accessories</b>	<b>A</b>
6101 Rail, silver, white. Available in following lengths: 4.5m, 5.0m, 5.5m, 6.0m. Available in silver only.	
6094 Roller glider with hook, 10, 100.	
6096 Strip glider. Outer, 1,000.	
6098 Roller glider with eye, 10, 100.	
6110 Dustcover for 6101, white, m.	
6124 Twist double ceiling fixing plate, silver, white, each.	
6137 Ceiling fixing plate (single), silver, white.	
6138 Ceiling fixing plate (double), silver, white.	
6143 Rotating glider, 20, 100.	
6146 Nylon hook only, 12, 100.	
6147 Nylon glider hook, 20.	
Box 500 (on strips). Outer 9,500.	
6160 Track insert for 6100, each.	
6190 Hanger rod assembly complete in silver and white, 61cm (2') or 91cm (3') or to order.	
6191 Hanger tube, silver and white, per metre.	
6192 Ceiling support complete with stud	
6193, silver and white, 100mm.	
6194 Track insert.	
6283 Roller glider, 10, 100.	
6501 'V' Hanger assembly system, silver, white.	
6503 Wall brackets complete, silver, white.	
25mm long with 50mm projection.	
50mm long with 50mm projection.	
100mm long with 50mm projection.	
200mm long with 50mm projection.	
50mm long with 100mm projection.	
100mm long with 100mm projection.	
75mm long with 150mm projection.	
6512 Connecting bridge, silver, white.	
6514 T-junction, single, silver, white.	
6524 Diagonal fixing support, silver, white.	
6525 Double 'T' junction, each, silver, white.	
6610 (old code 6609) Wall support, grey.	
6611 End cover with screw, grey, white, each.	
6625A Complete fixing sleeve, silver, white.	
6199 Internal connecting bridge.	
6187 Dummy ceiling support sleeve, silver, white.	
6175 Mini hanger, silver, white.	
0554 Loading device access.	
0553 Connecting bridge for loading device.	
0552 Transfer unit for loading device.	
11295 Endstop, silver, white, ea, 10.	

	Price Ctg.
<b>Accessories</b>	<b>A</b>
6675 Safety device.	
6655 Wall support.	
6677 V-hanger safety device.	
6663 Wall bracket connector plate.	
6666 Safety connecting bridge.	
6669 Dustcap for 6650.	
6671 Washer insert for wall support.	
6672 Cover for washer insert.	
6679 Acrylic disc for wall support.	

	Price Ctg.
<b>6103 Rail, silver and white, available in 6m lengths.</b>	<b>A</b>
6065 Twist eye endstop, each, 10.	
6094 Roller glider with hook, 10, 100.	
6096 Strip glider. Outer 1,000.	
6098 Roller glider with eye, 10, 100.	
6110 Dustcover, metre, white.	
6124 Twist double ceiling fixing plate, silver, white, each.	
6143 Rotating glider, 20, 100.	
6146 Nylon hook only, 12, 100.	
6147 Nylon glider hook, 20.	
Box 500 (on strips). Outer, 9,500.	
6193, 50mm, white and silver.	
6190 Hanger rod assembly complete in silver and white.	
61cm (2') 91cm (3') or to order.	
6191 Hanger tube, silver and white, per metre.	
6192 Ceiling support complete with stud	
6193, 100m each, silver, white.	
6194 Track insert.	
6283 Roller glider, 10, 100.	
6501 'V' Hanger assembly system, silver, white.	
6503 Wall brackets complete, silver, white	
25mm long with 50mm projection.	
50mm long with 50mm projection.	
100mm long with 50mm projection.	
200mm long with 50mm projection.	
50mm long with 100mm projection.	
100mm long with 100mm projection.	
75mm long with 150mm projection.	
6514M T-junction, single, silver, white.	
6525 Double 'T' junction, silver, white.	
6527 Wall support, metal, white.	
6620 Wall support complete, each, 10. Grey, each, 10. White.	
6625A Complete fixing sleeve, silver, white.	
6630 End cover, grey, white.	
6631 90° connector piece, grey, white.	
6635 Internal connecting bridge.	
6521 External connecting bridge, silver, white.	
6524 Diagonal fixing support, silver, white.	
6175 Mini hanger.	
11295 Endstop, silver, white, each, 10.	

	Price Ctg.
<b>Colours</b> (all colours except white and silver special order – see page 73).	<b>E</b>
<b>Bending</b>	
<b>Max. trade discount</b>	33 1/3%
Angle bend £69.50.	
Standard radius 25cm.	
Semi-circle or gradual curve £92.00 each.	

All prices shown exclude VAT



# Electric Curtain Track Systems

## SG 5100

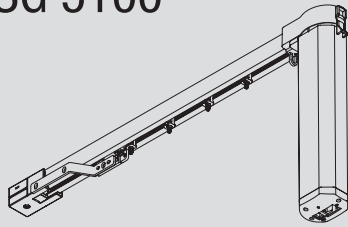

SG 5100 Base  
 SG 5100R with Remote Control  
 SG 5100T with Timer  
 SG 5100TC with Total Control



30cm std.

	Price Ctg.		Price Ctg.
<b>System Prices</b> Ready complete and assembled in white only.	A	<b>SG 5100 (all models)</b> For systems assembled with wave gliders please add the following supplement to standard system price.	A
<b>SG 5100</b> <b>Base</b> <b>Length</b> cm                      £		<b>Length</b> cm                      60mm                      80mm	
100                      601.94 150                      627.30 200                      652.75 250                      678.11 300                      703.47 350                      728.82 400                      754.19 450                      779.50 500                      804.87 550                      830.24 600                      855.60		100                      43.24                      37.00 150                      64.86                      55.51 200                      86.49                      74.00 250                      108.11                      92.52 300                      129.72                      111.02 350                      151.36                      129.53 400                      172.99                      148.03 450                      194.61                      166.55 500                      216.24                      185.06 550                      237.86                      203.56 600                      259.50                      222.07	
<b>SG 5100R</b> <b>with Remote Control</b> <b>Length</b> cm                      £	A	<b>Standard Accessories</b>	A
100                      680.21 150                      705.55 200                      730.91 250                      756.27 300                      781.62 350                      806.97 400                      832.32 450                      857.77 500                      883.14 550                      908.50 600                      933.88		18R Screw 25mm 0286 Cable Clips 1148C Countersunk screw No.8 31mm 5190 Motor 100-250v AC with 5m lead 10815 Cover White 10823 Belt Connector Arm 10824 Belt Connector Pin 10825 Drive Belt 10836 Hook White 10867 M4 x 16 screw 10925 Profile 10926 Clamp 10931 Roller Glider 10933 Belt Return & Motor Holder Set White 10936 Overlap Arm Set 10940 Belt Return 10945 Endstop 10949 1 Channel Wall Transmitter White 11116 Smart Fix Bracket Cover. 11120 Smart Fix 100mm Bracket (11202 Set).	
<b>SG 5100T</b> <b>with Timer</b> <b>Length</b> cm                      £	A	<b>Optional Accessories</b> (Additional charges may apply) 5192 24v DC moto 5193 Motor 100-240v AC with mains control 6349 Wave Curtain Tape FR 6363 Webbing Tape 70mm. For Wave Curtain 100mm 10905 Glider Cord 80mm for 6.5mm Channel 10906 Glider Cord 60mm for 6.5mm Channel 10943 Connecting Bridge 10946 1 Channel Transmitter White 10947 2 + 1 Channel Transmitter 10948 6 + 1 Channel Transmitter 10950 2 + 1 Channel Wall Transmitter 10951 5 + 1 Channel Wall Transmitter 11429 Timer White <b>Smart Fix Brackets in white or silver</b> 11119 Smart Fix 80mm Bracket (11201 Set). 11120 Smart Fix 100mm Bracket (11202 Set). 11121 Smart Fix 120mm Bracket (11203 Set). 11122 Smart Fix 150mm Bracket (11204 Set). 11123 Smart Fix 200mm Bracket (11205 Set). <b>Square Smart Fix Brackets in white or silver</b> 11140 Smart Fix 80mm Bracket (11211 Set). 11141 Smart Fix 100mm Bracket (11212 Set). 11142 Smart Fix 120mm Bracket (11213 Set). 11143 Smart Fix 150mm Bracket (11214 Set). 11144 Smart Fix 200mm Bracket (11215 Set). 11137 Square Smart Fix Bracket Cover. <b>Universal Smart Fix Extension Bracket in white or silver</b> 11154 Universal Smart Fix 120mm. 11155 Universal Smart Fix 150mm. 11156 Universal Smart Fix 200mm.	A
<b>SG 5100TC</b> <b>Total Control option</b> <b>Length</b> cm                      £	A	0722 2mm Allen Key	E
100                      869.58 150                      894.91 200                      920.26 250                      945.61 300                      970.97 350                      996.31 400                      1021.68 450                      1047.02 500                      1072.37 550                      1097.73 600                      1123.08		<b>Bending</b> <b>Max. trade discount</b> 33 1/3% Max 2 no. 90° bends or one curve: £193.00. Angle bends standard radius 30cm.	
<b>All prices shown exclude VAT</b>		Note: Autoglide is made-to-measure and cannot be cut down.	



# Electric Curtain Track Systems

## SG 5600

Electrically Operated  
Profile only 10850

Ready complete and assembled\*  
Supplied in white, black and anodised silver. Coordinating endpiece set and motor (white/grey/black).

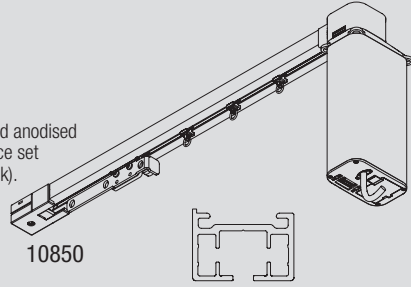

System Prices		Price
SG 5600 (9060 motor)		Catg.
Ready complete and assembled* 60mm wave is only applicable for pair stack. *12m-25m: These limits do not allow auto programming mode, touch and go or manual override		

SG 5600 with std roller glider/std Wave® glider (60*/80mm)		Price	
Shaded sizes are only applicable to standard roller glider (not standard Wave®)		Catg.	
Length	W/S	Price	
M	£	£	
1.5	1641.39	13.5	2517.67
2.0	1677.44	14.0	2553.75
2.5	1713.44	14.5	2589.80
3.0	1749.43	15.0	2625.88
3.5	1785.48	15.5	2661.96
4.0	1821.48	16.0	2698.02
4.5	1857.47	16.5	2734.09
5.0	1893.53	17.0	2770.15
5.5	1929.52	17.5	2806.22
6.0	1965.52	18.0	2842.31
6.5	2013.16	18.5	2878.34
7.0	2049.15	19.0	2914.42
7.5	2085.14	19.5	2950.49
8.0	2121.19	20.0	2986.56
8.5	2157.19	20.5	3022.63
9.0	2193.19	21.0	3058.69
9.5	2229.23	21.5	3094.76
10.0	2265.21	22.0	3130.84
10.5	2301.27	22.5	3166.90
11.0	2337.34	23.0	3202.96
11.5	2373.41	23.5	3239.03
12.0	2409.48	24.0	3275.09
12.5	2445.54	24.5	3311.17
13.0	2481.62	25.0	3347.25

SG 5600 with roller Wave® glider (60*/80mm)		Price	
Shaded sizes are only applicable to standard roller glider (not standard Wave®)		Catg.	
Length	W/S	Price	
M	£	£	
1.5	1707.06	13.5	3108.79
2.0	1765.01	14.0	3166.75
2.5	1822.90	14.5	3224.71
3.0	1880.80	15.0	3282.67
3.5	1938.73	15.5	3340.63
4.0	1996.61	16.0	3398.59
4.5	2054.52	16.5	3456.55
5.0	2112.45	17.0	3514.51
5.5	2170.33	17.5	3572.47
6.0	2228.25	18.0	3630.43
6.5	2286.17	18.5	3688.39
7.0	2344.06	19.0	3746.35
7.5	2401.95	19.5	3804.31
8.0	2459.84	20.0	3862.27
8.5	2517.76	20.5	3920.23
9.0	2575.67	21.0	3978.19
9.5	2633.56	21.5	4036.15
10.0	2691.45	22.0	4094.11
10.5	2749.34	22.5	4152.07
11.0	2807.26	23.0	4210.04
11.5	2865.17	23.5	4268.00
12.0	2923.09	24.0	4325.96
12.5	2981.00	24.5	4383.92
13.0	3038.91	25.0	4441.88

SMART by Silent Gliss - For SG 5600 control via third party control systems, please add the below per system:		Price
11270 Plug in SMART motor module, white Add £254.88 per system		Catg.
**Power supplies not included - see separate associated components prices, page 28.		

SG 5600 with radio module, std roller glider/std wave glider (60*/80mm)		Price	
Length	W/S	Price	
M	£	£	
1.5	1869.80	13.5	2746.04
2.0	1905.78	14.0	2782.12
2.5	1941.76	14.5	2818.17
3.0	1977.78	15.0	2854.23
3.5	2013.82	15.5	2890.31
4.0	2049.82	16.0	2926.38
4.5	2085.84	16.5	2962.45
5.0	2121.84	17.0	2998.50
5.5	2157.86	17.5	3034.58
6.0	2193.85	18.0	3070.65
6.5	2241.50	18.5	3106.72
7.0	2277.49	19.0	3142.76
7.5	2313.52	19.5	3178.85
8.0	2349.53	20.0	3214.92
8.5	2385.53	20.5	3250.98
9.0	2421.52	21.0	3287.06
9.5	2457.55	21.5	3323.11
10.0	2493.56	22.0	3359.19
10.5	2529.64	22.5	3395.25
11.0	2565.69	23.0	3431.32
11.5	2601.78	23.5	3467.40
12.0	2637.82	24.0	3503.45
12.5	2673.90	24.5	3539.53
13.0	2709.96	25.0	3575.59

SG 5600 with radio module and roller wave glider (60*/80mm)		Price	
Length	W/S	Price	
M	£	£	
1.5	1935.46	13.5	3337.14
2.0	1993.35	14.0	3395.10
2.5	2051.22	14.5	3453.06
3.0	2109.14	15.0	3511.02
3.5	2167.07	15.5	3568.98
4.0	2224.97	16.0	3626.94
4.5	2282.87	16.5	3684.90
5.0	2340.77	17.0	3742.86
5.5	2398.67	17.5	3800.82
6.0	2456.57	18.0	3858.78
6.5	2514.46	18.5	3916.75
7.0	2572.35	19.0	3974.71
7.5	2630.24	19.5	4032.67
8.0	2688.14	20.0	4090.63
8.5	2746.03	20.5	4148.59
9.0	2803.93	21.0	4206.55
9.5	2861.82	21.5	4264.51
10.0	2919.72	22.0	4322.47
10.5	2977.61	22.5	4380.43
11.0	3035.50	23.0	4438.39
11.5	3093.40	23.5	4496.35
12.0	3151.29	24.0	4554.31
12.5	3209.18	24.5	4612.27
13.0	3267.07	25.0	4670.23

**5600 Black**

Please add a 10% uplift to the White pricing tables.

Note: if a 5600 is ordered in black with one of the following glider types:

- 10840 2C Roller Glider
- 10869 Wave Roller Glider Cord 60mm
- 10852 Wave Roller Glider Cord 80mm

The gliders will be supplied in black as standard.

Standard Accessories		Price
		Catg.
3004	Clamp	C
9060	Motor, white, grey, black	C
9916	In-line connector	C
10816	Motor cover, white, grey, black	C
10817	Motor case holder, white, grey, black	C
10819	Belt return, white, grey, black	C
10820	Overlap arm, straight, white, black	C
10821	Overlap arm, bent, white, black	C
10822	Master carrier set, white, black	C
10826	Overlap arm support set	C
10837	Pilot runner arm, white, black	C
10838	Pilot runner set, white, black	C
10840	2C Roller glider, white, black	C
10850	Profile, white, silver, black per metre	C

Standard Accessories		Price
		A
10815	Cover, white, grey, black	
10825	Belt	
10836	Mask pair stack, white, grey, black	

Optional Accessories		Price
		Catg.
3041	Bracket	C
5118	Wedge for recess profile, white, black	C
6794	Screw for direct fix	C
9063	Radio module set for 9940 Radio system, grey, white, black	C
9960	Move Server Unit	C
10862	Recess profile, white, black per metre	C
10863	Recess mask, motor, white, black	C
10864	Recess mask, belt return, white, black	C
10865	Mounting support plate	C
10821L	Long overlap arm bent	C
10822	Master carrier set, white	C
10831	Connecting bridge	C
10838	Pilot runner set, white	C
10844	Wave end stop, motor, grey, white, black	C
10845	Wave master carrier, white, black single stack 80mm	C
10852	Wave roller glider cord, black, white (80mm pitch), 6.5mm channel	C
10856	Wave end stop, belt return, white, grey, black	C
10869	Wave roller glider cord, white, black (60mm pitch), 6.5mm channel	C
10886	Wave overlap arm, pilot runner set, white, black	C
10887	Wave overlap arm set, white, black	C
10926	Wave glider support	C
11411	Radio module set for 0450 Radio system, grey, white, black	C
11412	Power supply 24V DC UL	C

Optional Accessories		Price
		Catg.
3832	Twist clamp	A
3582	Curtain hook, white, black box, 100. Self-service sachets, 25 x 25. Outer, 20,000	A
6094	Roller glider with hook, 10, 100	A
6105	Hanger with plate	A
6107	V-Hanger with plate	A
6349	Wave @ curtain tape, white, black	A
6363	Top hemming tape	A
7002	Profile protector	A
10075	Lead weight 50 gr/m	A
10076	Fabric weight	A
10823	Belt connector arm	A
10824	Belt connector pin	A
10854	Wave overlap support arm, white, black	A
10805	Wave glider cord, white (80mm pitch), 6.5mm channel	A
10906	Wave glider cord, white (60mm pitch), 6.5mm channel	A
10924	Wave glider support, white, black	A
11116	Smart Fix Bracket Cover	A
11137	Square Smart Fix Bracket Cover	A
Smart Fix Brackets in white, black or silver		A
11118	Smart Fix 60mm Bracket (11200 Set).	A
11119	Smart Fix 80mm Bracket (11201 Set).	A
11120	Smart Fix 100mm Bracket (11202 Set).	A
11121	Smart Fix 120mm Bracket (11203 Set).	A
11122	Smart Fix 150mm Bracket (11204 Set).	A
11123	Smart Fix 200mm Bracket (11205 Set).	A
Square Smart Fix Brackets in white, black or silver		A
11139	Smart Fix 60mm Bracket (11210 Set).	A
11140	Smart Fix 80mm Bracket (11211 Set).	A
11141	Smart Fix 100mm Bracket (11212 Set).	A
11142	Smart Fix 120mm Bracket (11213 Set).	A
11143	Smart Fix 150mm Bracket (11214 Set).	A
11144	Smart Fix 200mm Bracket (11215 Set).	A
Universal Smart Fix Extension Bracket in white, black or silver		A
11154	Universal Smart Fix 120mm.	A
11155	Universal Smart Fix 150mm.	A
11156	Universal Smart Fix 200mm.	A

Recess Profile and Accessories White or Black		Price
Charged at the nearest 25cm increment above.		Catg.
Add to price	Per Metre	Per Track
White	£52.59	£10.68

Colours		Price
Other colours special order, see page 73.		Catg.

Tools		Price
7426 Notching tool for recess 10862		Catg.

Bends		Max. trade discount	25%
For each bend add the following to above system price:			
Radius/cm	Profile 10850		
25-99	£182.50		
Standard angle bend radius 25cm.			
Over 99	£342.00		

Note: If using recess profile, price add an additional 20% to the relevant bending charge above. Please note: Minimum radius for 5600 is 25cm. Minimum radius for 5600 with recess profile is 50cm.

Multiple System Operation		Price
A wide range of multiple operation methods are available, including low voltage control, radio/remote control and mixed systems. Can also be controlled through a smartphone, tablet or desktop with the Silent Gliss app 'Move' (refer to page 28 for pricing details). Please consult the Silent Gliss catalogue.		Catg.

All prices shown exclude VAT





# Electric Curtain Track Systems

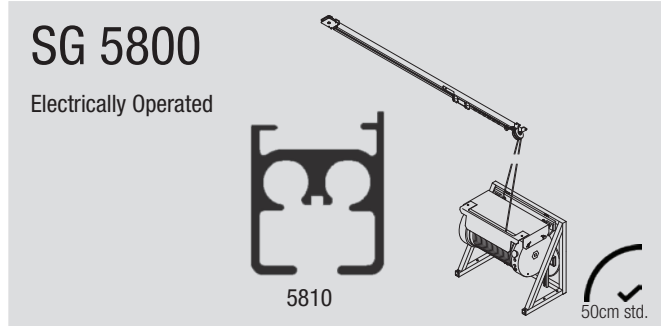

			Price Ctg.				Price Ctg.								
<b>System Prices</b>			<b>C</b>	<b>Optional Accessories</b>			<b>C</b>								
Ready complete and assembled (as far as possible depending on transport requirements).				(Additional charges may apply) 0578 Recess pattress, metal. 0615 Latching switch 6228 Double fixing plate. 5829 2 Hole fixing plate. 5813 Floor mounting frame.											
Length	Price Single Track	Price 2 Parallel Tracks		<b>Colours</b>				<b>E</b>							
M	£	£		Special quotation.											
12	22464.77	30913.10		<b>Bending</b>					<b>25%</b>						
13	22929.17	31841.83		Radius	Max. trade discount	<b>Each</b>									
14	23356.14	32695.76		cm	£					<b>379.50</b>					
15	23783.09	33549.70		32-99							<b>562.50</b>				
16	24210.07	34403.66		99-349								<b>734.50</b>			
17	24637.03	35257.58		Over 350									<b>Standard angle bend radius 50cm</b>		
18	25064.04	36111.56		<b>Remote/Multiple System Operation</b>										<b>C</b>	
19	25528.36	37040.27		Must not be wired in parallel. For information consult Silent Gliss.											
20	25955.35	37894.25													
21	26382.33	38748.17													
22	26809.29	39602.10													
23	27236.27	40456.05													
24	27663.25	41309.99													
25	28127.60	42238.77													
26	28554.58	43092.70													
27	28981.54	43946.63													
<p>SG 5800 can cover windows up to 60m if pair stacked. On lengths of this size Silent Gliss advice should be sought but as a guide price for each metre above 27m the following should be added:</p> <p><b>Single width</b> £399.50 <b>Two tracks in parallel</b> £839.50</p> <p>Track lengths between those specified will be charged at the rate for the nearest metre above. Price includes 6209 Top fix clamps, 5821/22 Wall mounting for motor, 5811 Overlap, 5809 Roller gliders at 5 per metre and where length exceeds 6 metres 6203 Connecting bridge. 0615 plastic switch with recess box. Earth is required.</p>															
<b>Standard Accessories</b>															
5806 Pilot Runner.															
5809 Roller glider, 10.															
5810 Silver profile only.															
5824 Endstop.															
5811 Overlap.															
5814 Cable, metre.															
5815 Cord guide return.															
5816 Cord guide.															
5834 Cable connector.															
6203 Connecting bridge.															
6209 Clamp, each, 10.															
All prices shown exclude VAT															



# Switches and Controls

## SG Control R SG 0450

Radio controlled systems

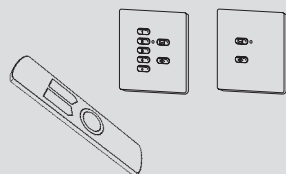

## SG Control L SG 9940

Radio controlled systems

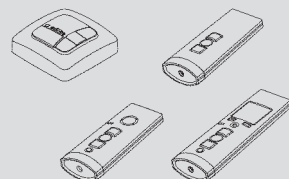

## SG SMART by Silent Gliss

For control via third party control systems

## SG Control A SG5100/Battery SG2345/4955

Operated Blinds  
Remote and Wall Plates

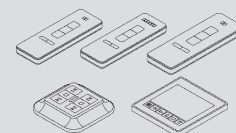

All costs for systems indicated in this section are exclusive of curtain/blind systems and need to be added for total cost. On-site wiring costs are also excluded although advisory service is available. To assist choosing the correct equipment please see application chart in the back of the price list.

10949 come as standard with SG5100 Autoglide system and battery SG2345/SG4955 systems. This can not be exchanged/returned for another control.

	Price Ctg.		Price Ctg.		Price Ctg.		Price Ctg.
<b>SG 0450</b>	<b>C</b>	<b>SG 9940</b>	<b>C</b>	0323	£2.42	<b>SG Control A System</b>	<b>A</b>
Radio control system, up to 255 room and blind addresses, individually or simultaneously. Can be used with mains switched motors and 24V switched motor systems. Low voltage option (motor type C) available on request.		9068	£512.76	0.5m Blue Patch Cable		<b>SG5100/2345/4955</b>	
20919	£384.89	Single-channel receiver		11260	£967.22	10949	£54.93
Control module for mains switched motors		9944	£393.18	Gateway		1 Channel Wall Transmitter, White	
20907	£415.52	Single-channel receiver, non latching		11261	£1163.28	10950	£81.27
Control module for 24V dc switched motors		9945	£355.50	Gateway KNX		2 + 1 Channel Wall Transmitter, White	
20913	£318.70	Single-channel receiver, latching		11262	£941.08	10951	£81.27
Single-channel wall switch. Available in the following colours:		9947	£232.33	Expansion Unit		5 + 1 Channel Wall Transmitter, White	
Antique Brass		Control Unit DC 24V		11263	£90.04	10946	£66.23
Black Nickel		10300	£289.04	Power supply 24V DC 2 Ampere DIN Rail		1 Channel Remote	
Chocolate Bronze		Single-channel hand-held remote		11264	£109.94	10947	£81.27
Matt Black		10302	£289.04	Power supply 24V DC 3.8 Ampere DIN Rail		2 + 1 Channel Remote	
Matt White		10302	£289.04	Power supply 24V DC 5 Ampere DIN Rail		10948	£81.27
Polished Brass		10303	£352.29	11265	£116.37	6 + 1 Channel Remote	
Mirror Polish		10+2+1 channel hand-held remote. Inc. timer		11266	£214.62	11429	£160.30
Brushed Silver		10804	£352.28	Power supply 24V DC 10 Ampere DIN Rail		Single Channel Timer	
20914	£318.70	15+5+1 channel hand-held remote		11270	£254.88		
Eight-channel wall switch. Available in the following colours:		Hand-held remotes are available in White, Silver or Anthracite		SMART module set white		<b>Fixed switches for mains Switched Motors</b>	<b>C</b>
Antique Brass		11412	£78.15	11281	£2918.38	Switches are available single or in banks as below.	
Black Nickel		Power supply 24V DC		Cabinet up to 8 Shading Device Unit including Circuit Breaker Protection		Add switches price to price of system.	
Chocolate Bronze		11480	£148.40	11282	£3763.43	Switches are designed for recess fixing.	
Matt Black		1 channel wall switch		Cabinet up to 24 Shading Device Unit including Circuit Breaker Protection		<b>Non-latching</b>	
Matt White		11490	£272.20	11283	£7133.82	1 Gang Switches	
Polished Brass		5 channel wall switch		Cabinet up to 56 Shading Device Unit including Circuit Breaker Protection		0565/W White plastic	£133.56
Mirror Polish				11318	£12.16	2 Gang Switches	
Brushed Silver				4-Pin Connector for 5600 SMART module		0566/W White plastic	£231.20
20336	£235.27			11319	£12.16	3 Gang Switches	
Eight channel hand held remote				4-Pin Connector for SMART motor (Room/Control/Side)		0567/W White plastic	£360.03
				11320	£18.23	4 Gang Switches	
				4-Pin Connector for SMART motor (Motor side)		0568/W White plastic	£457.69
				11325	£16.07	6 Gang Switches	
				6-Pin Connector for Gateway and Expansion Unit		0569/W White plastic	£690.98
						<b>Latching</b>	
				11269	£130.71	1 Gang Switches	
				Hand held setting tool for Series 40 and SMART motors (TTPRO)		0615/W White plastic	£72.14
				<b>Labour</b>	<b>E</b>	2 Gang Switches	
				To fully assemble cabinet with SMART Gateway, expansion unit (if required) and Power Supplies:		0616 White plastic	£97.22
				Up to 8 systems (Labour cost only)		3 Gang Switches	
				£226.60		0617 White plastic	£157.98
				Up to 24 systems (Labour cost only)		4 Gang Switches	
				£226.60		0618 White plastic	£189.99
				Up to 56 systems (Labour cost only)		6 Gang Switches	
				£226.60		0619 White plastic	£263.29
						<b>Extras</b>	
				Series 50 SMART by Silent Gliss motors for use with Silent Gliss Gateway and associated components – Add on £254.88 per system for 4960/ 4970/ 2350/ 4760/ 4770/ 4780/ 5600	<b>C</b>	9959 Relay	£194.42
				Add on £326.77 per system for 4880		9953 Volt free interface	£252.23
						<b>Tools</b>	<b>E</b>
						11269 Handheld setting tool for Series 40 and Series 50 SMART Motors TTPRO	£130.71
						11422 230V Setting lead	£39.21

All prices shown exclude VAT



# Roman Blind Systems

## SG 2120

Chain operated headrail system for Roman Blinds. For medium to heavy weight applications.

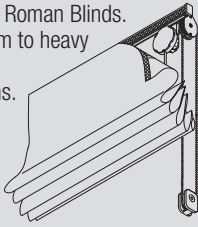

## SG 2305

Chain operated headrail system for Roman Blinds with integral child safety breakaway mechanism. For medium to heavy weight applications.

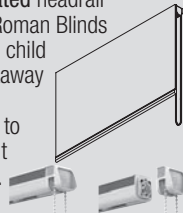

	Price Ctg.																																	
<b>SG 2120 System supplied ready assembled</b> Total max. curtain weight 8kg incl. any weighting. Maximum width: 4.0m Maximum drop: 6.0m <b>System width</b> <table border="1"> <thead> <tr> <th>cms</th> <th>£</th> </tr> </thead> <tbody> <tr><td>100</td><td>223.33</td></tr> <tr><td>125</td><td>257.11</td></tr> <tr><td>150</td><td>300.39</td></tr> <tr><td>175</td><td>344.66</td></tr> <tr><td>200</td><td>378.43</td></tr> <tr><td>225</td><td>421.93</td></tr> <tr><td>250</td><td>465.49</td></tr> <tr><td>275</td><td>499.29</td></tr> <tr><td>300</td><td>542.85</td></tr> <tr><td>325</td><td>586.43</td></tr> <tr><td>350</td><td>636.18</td></tr> <tr><td>375</td><td>673.63</td></tr> <tr><td>400</td><td>717.20</td></tr> </tbody> </table> Above prices are based on standard accessories detailed below.	cms	£	100	223.33	125	257.11	150	300.39	175	344.66	200	378.43	225	421.93	250	465.49	275	499.29	300	542.85	325	586.43	350	636.18	375	673.63	400	717.20	<b>A</b>					
cms	£																																	
100	223.33																																	
125	257.11																																	
150	300.39																																	
175	344.66																																	
200	378.43																																	
225	421.93																																	
250	465.49																																	
275	499.29																																	
300	542.85																																	
325	586.43																																	
350	636.18																																	
375	673.63																																	
400	717.20																																	
<b>Standard Accessories</b> 2049 Gear drive, each, 10, 100. 2081 Take-up reel, each, 10. 2059 Safety clip, 10. 2111 Hexagonal bar, 6m length, outer of 50 lengths. 2163 Flat drawing tape, per m, 200m 2211 Touch and close headrail, 6m, length. 2179 End cover, each, 10. 3630 Universal bracket, each, 10, 100. 4845 Metal bead chain, 125m reel. 2865 Twin chain connector, each.	<b>A</b>																																	
10731 Cord retainer.	<b>E</b>																																	
<b>Optional Accessories</b> (Additional Charges May Apply) 0549 Touch and close pencil pleat tape for Austrian Blinds. 2091 Endcover (for 2135) 3164 Breakaway hook and latch set. 3165 Breakaway ring set (soft fold). 3166 Breakaway ring tape (soft fold). 2006 Bottom weight bar, 4m. 2072A Universal joint, each. 2135 Steel rod, 3m lengths. 2164T Ring tape, 100m. 2539 Touch and close pile section, 25m, 100m. 3069 Breakaway rod cover (hard fold). 11116 Smart Fix Bracket Cover. 11137 Square Smart Fix Bracket Cover. <b>Smart Fix Brackets in white or silver</b> 11118 Smart Fix 60mm Bracket (11200 Set). 11119 Smart Fix 80mm Bracket (11201 Set). 11120 Smart Fix 100mm Bracket (11202 Set). 11121 Smart Fix 120mm Bracket (11203 Set). 11122 Smart Fix 150mm Bracket (11204 Set). 11123 Smart Fix 200mm Bracket (11205 Set). <b>Square Smart Fix Brackets in white or silver</b> 11139 Smart Fix 60mm Bracket (11210 Set). 11140 Smart Fix 80mm Bracket (11211 Set). 11141 Smart Fix 100mm Bracket (11212 Set). 11142 Smart Fix 120mm Bracket (11213 Set). 11143 Smart Fix 150mm Bracket (11214 Set). 11144 Smart Fix 200mm Bracket (11215 Set). 3603 Top fix brackets, each, 10, 100. 3655 Long universal bracket. 3660 Extra long universal bracket. 4845BR Metal bead chain, brass.	<b>A</b>																																	
<b>Tools</b> 0679 Connector tongs.	<b>E</b>																																	
<b>SG 2305 System</b> Supplied made to measure, ready assembled. Maximum width: 3.0m Maximum drop: 3.4m <table border="1"> <thead> <tr> <th>System width cms</th> <th>White £</th> <th>Black £</th> </tr> </thead> <tbody> <tr><td>75</td><td>69.64</td><td>83.56</td></tr> <tr><td>100</td><td>84.73</td><td>101.67</td></tr> <tr><td>125</td><td>91.45</td><td>109.74</td></tr> <tr><td>150</td><td>104.80</td><td>125.76</td></tr> <tr><td>175</td><td>111.53</td><td>133.83</td></tr> <tr><td>200</td><td>124.87</td><td>149.83</td></tr> <tr><td>225</td><td>139.98</td><td>167.97</td></tr> <tr><td>250</td><td>146.69</td><td>176.36</td></tr> <tr><td>275</td><td>160.05</td><td>192.05</td></tr> <tr><td>300</td><td>166.78</td><td>200.13</td></tr> </tbody> </table> Above prices are based on standard accessories detailed below.	System width cms	White £	Black £	75	69.64	83.56	100	84.73	101.67	125	91.45	109.74	150	104.80	125.76	175	111.53	133.83	200	124.87	149.83	225	139.98	167.97	250	146.69	176.36	275	160.05	192.05	300	166.78	200.13	<b>A</b>
System width cms	White £	Black £																																
75	69.64	83.56																																
100	84.73	101.67																																
125	91.45	109.74																																
150	104.80	125.76																																
175	111.53	133.83																																
200	124.87	149.83																																
225	139.98	167.97																																
250	146.69	176.36																																
275	160.05	192.05																																
300	166.78	200.13																																
<b>Please note:</b> Instead of standard silver metal chain (on white systems) corresponding white plastic chain can be supplied at no extra cost.																																		
<b>Standard Accessories</b> 2301 Aluminium headrail white, black (5.8m). 2309 Hex bar (5m). 2308 Spool with lift cord, white, black. 2307 Gear/Breakaway set (4:1), white, black. 2302 Clip bracket, white, black. 2311 Metal chain, silver, black (150m reel).	<b>A</b>																																	
<b>Optional Accessories</b> (Additional Charges May Apply) 2091 Endcover (for 2135) 2310 Plastic operating chain (250m reel), white. 2311AB Metal chain, antique brass (150m reel) 2311BL Metal chain, pewter (150m reel) 2311GD Metal chain, gold (150m reel) 2312 Bead chain joiner. 2346 Clamp bracket. 2347/50 50cm finished plastic chain drop. 2347/75 75cm finished plastic chain drop. 2347/100 100cm finished plastic chain drop. 2347/125 125cm finished plastic chain drop. 2347/150 150cm finished plastic chain drop. 2347/175 175cm finished plastic chain drop. 2347/200 200cm finished plastic chain drop. 3164 Breakaway hook and latch set. 3165 Breakaway ring set (soft fold). 3166 Breakaway ring tape (soft fold). 2005 Bottom bar. 2006 Bottom bar. 2135 Steel rod, 3m lengths. 2164T Ring tape, 100m. 2539 Touch and close pile section, 25m, 100m. 3069 Breakaway rod cover (hard fold). 11116 Smart Fix Bracket Cover. 11137 Square Smart Fix Bracket Cover. <b>Smart Fix Brackets in white, black or silver</b> 11118 Smart Fix 60mm Bracket (11200 Set). 11119 Smart Fix 80mm Bracket (11201 Set). 11120 Smart Fix 100mm Bracket (11202 Set). 11121 Smart Fix 120mm Bracket (11203 Set). 11122 Smart Fix 150mm Bracket (11204 Set). 11123 Smart Fix 200mm Bracket (11205 Set). <b>Square Smart Fix Brackets in white, black or silver</b> 11139 Smart Fix 60mm Bracket (11210 Set). 11140 Smart Fix 80mm Bracket (11211 Set). 11141 Smart Fix 100mm Bracket (11212 Set). 11142 Smart Fix 120mm Bracket (11213 Set). 11143 Smart Fix 150mm Bracket (11214 Set). 11144 Smart Fix 200mm Bracket (11215 Set).	<b>A</b>																																	
0600 Connector tongs for metal chain. 7223 Tongs for connector 2865 10731 Cord retainer	<b>E</b>																																	

All prices shown exclude VAT



# Roman Blind Systems

## SG 2345

Battery Operated

Battery operated radio controlled for Roman Blinds

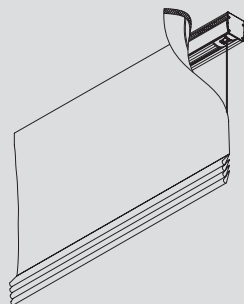

## SG 2350

Electrically Operated

For medium/heavy Roman Blinds.

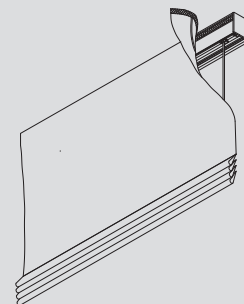

Battery operated SG 2345 supplied ready assembled		Price Ctg.
Total maximum curtain weight 2.5kg. Maximum width 6 metres. Maximum drop 6 metres, maximum total surface area 36m <sup>2</sup> depending on curtain weight. Minimum width 60cm. Hardware only cost.		C
SYSTEM		
WIDTHS (cms)	£	
100	589.63	
125	616.93	
150	650.72	
175	677.94	
200	710.16	
225	746.80	
250	771.22	
275	807.78	
300	832.21	
325	859.44	
350	893.17	
375	920.43	
400	952.74	
425	989.28	
450	1013.73	
475	1050.26	
500	1074.70	
525	1102.00	
550	1135.76	
575	1162.98	
600	1187.39	

Above prices are based on Standard Accessories detailed below.

Standard Accessories		Price Ctg.	
1148C	No.8 Cross Head Woodscrew	A	
2216	Cord		
2221	Hook Tape		
2351	Profile White for system 2345		
2352	Profile silver for system 2345		
10949	1 Channel Wall Transmitter White		
2353	Motor cover for system 2345		
2354	Cover for system 2345		
2357	Pin for system 2345		C
2358	Shell for system 2345		
2359	Support for system 2345		
2361	Adaptor for system 2345		
2363	Wall/Ceiling Bracket		
2368	Motor Adaptor Plate for SG2345		
3003	Clamp		
11071	Motor Drive for SG2345		
11074	Tube adaptor for SG2345		
11076	1.2nm Motor for 2345		
11077	Battery Box for Motor 11076		
11085	Battery Box Holder		
11099	Battery for 2345		

All prices shown exclude VAT

Optional Accessories		Price Ctg.
(Additional Charges May Apply)		A
3069	Breakaway Rod Cover	
3164	Breakaway Hook and latch set	
3165	Breakaway ring set (soft fold)	
3166	Breakaway ring tape (soft fold)	
2135	Steel Rod	
3069	Breakaway rod cover (hard fold)	
2005	Bottom Bar	
2006	Weight bar	
10946	Radio hand-held transmitter 1 channel	
10947	Radio hand-held transmitter 2 + 1 channel	
10948	Radio hand-held transmitter 6 + 1 channel	
10950	Radio wall transmitter 2 channel	
10951	Radio wall transmitter 5 + 1 channel	
11429	Timer White	
Smart Fix Brackets in white, black or silver		
11118	Smart Fix 60mm Bracket (11200 Set).	
11119	Smart Fix 80mm Bracket (11201 Set).	
11120	Smart Fix 100mm Bracket (11202 Set).	
11121	Smart Fix 120mm Bracket (11203 Set).	
11122	Smart Fix 150mm Bracket (11204 Set).	
11123	Smart Fix 200mm Bracket (11205 Set).	
Square Smart Fix Brackets in white, black or silver		
11139	Smart Fix 60mm Bracket (11210 Set).	
11140	Smart Fix 80mm Bracket (11211 Set).	
11141	Smart Fix 100mm Bracket (11212 Set).	
11142	Smart Fix 120mm Bracket (11213 Set).	
11143	Smart Fix 150mm Bracket (11214 Set).	
11144	Smart Fix 200mm Bracket (11215 Set).	
Smart Fix Bracket Covers		
11116	Smart Fix Bracket Cover.	
11137	Square Smart Fix Bracket Cover.	
Universal Smart Fix Extension Bracket in white, black or silver		
11154	Universal Smart Fix 120mm.	
11155	Universal Smart Fix 150mm.	
11156	Universal Smart Fix 200mm.	

2362	Wire Holder	C
2521	Bracket	
8235	Wire Base Short	
8236	Wire Base Long	
8237	Wire Holder	
8249	Locking ring	

Electrically operated 2350 for straight vertically-hung Austrian, Roman and Festoon Blinds		Price Ctg.
Total maximum curtain weight 15kg. Maximum width 6 metres. Maximum drop 6 metres, maximum total surface area 36m <sup>2</sup> depending on curtain weight.		C
Hardware cost only, including series 20 mains switched motor (for alternative motors see next column).		
WIDTHS (cms)	£	
100	991.94	
150	1040.15	
200	1088.44	
250	1136.72	
300	1184.99	
350	1233.23	
400	1281.54	
450	1329.79	
500	1378.03	
550	1426.31	
600	1474.56	

Optional Accessories		Price Ctg.
(Additional Charges May Apply)		A
3164	Breakaway hook and latch set.	
3165	Breakaway ring set (soft fold).	
3166	Breakaway ring tape (soft fold).	
2005	Bottom bar	
2006	Bottom bar 1m, 5m	
2109	Eyelet	
2144	Cross Rail	
2164T	Ring Tape	
2539	Touch and close pile section, 25m, 100m	
2616	Bracket (40.8mm)	
3069	Breakaway rod cover (hard fold).	
11116	Smart Fix Bracket Cover.	
11137	Square Smart Fix Bracket Cover.	
Smart Fix Brackets in white, black or silver		
11118	Smart Fix 60mm Bracket (11200 Set).	
11119	Smart Fix 80mm Bracket (11201 Set).	
11120	Smart Fix 100mm Bracket (11202 Set).	
11121	Smart Fix 120mm Bracket (11203 Set).	
11122	Smart Fix 150mm Bracket (11204 Set).	
11123	Smart Fix 200mm Bracket (11205 Set).	
Square Smart Fix Brackets in white, black or silver		
11139	Smart Fix 60mm Bracket (11210 Set).	
11140	Smart Fix 80mm Bracket (11211 Set).	
11141	Smart Fix 100mm Bracket (11212 Set).	
11142	Smart Fix 120mm Bracket (11213 Set).	
11143	Smart Fix 150mm Bracket (11214 Set).	
11144	Smart Fix 200mm Bracket (11215 Set).	

2363	Wall/ceiling bracket	C
2521	Bracket (49.6mm)	

Remote/Multiple System Operation		Price Ctg.
For system operation possibilities refer to table on page 91		C
Side-guide option available at an additional cost of £83.51.		
System Control Options		C
Radio control standard option is with System 0450, see page 28.		
Series 40 motors – With integrated radio receiver for operation with SG wireless system 9940 – add on £254.88 per system, see page 28. NOTE: 24v Series 40 Motors are not supplied with power supplies (transformers) as standard. They must be ordered separately, see page 28.		
Series 50 SMART by Silent Gliss motors – for use with Silent Gliss Gateway and associated components – add on £254.88 per system, see page 28.		





# Made-to-measure Roman Blinds

Prices below comprise of the complete system made-to-measure, ready-to-hang on SG 2305 white with chosen fabric.  
Maximum width 3m, maximum drop 3.4m. (Minimum system width 60cm).

PRICE GROUP 1      Colorama Acoustic      Colorama 1 Multicolour      \*\*Multicolour Natura  
                                  Colorama 1      \*Colorama 2      \*\*Multicolour Panama  
                                  Colorama 1 Alu      \*Colorama 2 Bioactive      \*Oscurante  
                                  Colorama 1 Bioactive      \*Colorama 2 Eco      Polyflax  
                                  Colorama 1 Eco      \*Colorama 2 Multicolour      Valere

Price Category 'A'

Width Drop cm	100cm	120cm	140cm	160cm	180cm	200cm	220cm	240cm	260cm	280cm	300cm	Width Drop cm
100	422.15	432.34	463.00	472.49	482.06	490.84	522.21	531.70	541.19	571.85	580.71	100
120	457.75	468.41	499.62	510.29	520.25	530.29	562.13	572.16	582.12	613.26	623.30	120
140	492.41	503.55	535.23	546.36	557.58	568.09	600.40	610.90	622.75	654.43	664.94	140
160	526.29	538.68	570.83	583.14	594.83	605.89	639.37	650.35	662.74	694.89	706.58	160
180	560.95	573.81	607.14	619.92	631.45	643.68	677.64	689.80	702.66	735.99	748.22	180
200	594.91	608.87	642.74	656.08	668.78	681.48	716.62	729.32	742.65	776.45	789.16	200
220	630.43	645.02	679.29	693.80	707.05	720.85	755.83	769.71	783.59	818.56	831.74	220
240	665.09	680.07	714.89	729.95	744.30	758.65	794.80	809.15	823.51	859.03	873.38	240
260	699.05	714.58	751.20	766.73	781.55	796.45	833.07	847.97	864.13	900.12	915.02	260
280	733.63	749.63	786.80	802.80	818.88	834.25	872.05	887.42	904.12	940.59	956.67	280
300	767.59	784.77	822.41	839.66	856.13	872.05	910.32	926.87	944.04	981.76	997.60	300
320	803.19	820.84	859.03	876.68	894.40	911.42	950.23	967.33	984.98	1023.17	1040.18	320
340	837.78	855.97	895.34	913.53	931.02	949.22	988.58	1006.78	1024.97	1064.26	1081.85	340

PRICE GROUP 2      \*Colorama Dimout      \*Leviso Light  
                                  \*Multicolour Dimout      \*Reflex

Width Drop cm	100cm	120cm	140cm	160cm	180cm	200cm	220cm	240cm	260cm	280cm	300cm	Width Drop cm
100	516.25	526.44	557.11	566.60	576.16	584.95	616.32	625.80	635.29	665.96	674.81	100
120	561.26	571.93	603.14	613.81	623.77	633.80	665.64	675.68	685.64	716.77	726.81	120
140	605.34	616.47	648.15	659.29	670.50	681.01	713.32	723.83	735.67	767.36	777.86	140
160	648.63	661.02	693.17	705.48	717.17	728.22	761.71	772.69	785.08	817.23	828.92	160
180	692.70	705.56	738.89	751.67	763.20	775.43	809.39	821.54	834.41	867.74	879.97	180
200	736.07	750.02	783.90	797.23	809.94	822.64	857.78	870.48	883.81	917.61	930.32	200
220	781.00	795.59	829.86	844.37	857.62	871.42	906.40	920.28	934.16	969.13	982.31	220
240	825.07	840.05	874.87	889.93	904.28	918.63	954.78	969.13	983.49	1019.01	1033.36	240
260	868.44	883.97	920.59	936.12	950.94	965.84	1002.46	1017.36	1033.52	1069.51	1084.41	260
280	912.44	928.43	965.61	981.60	997.68	1013.05	1050.85	1066.22	1082.92	1119.39	1135.47	280
300	955.80	972.98	1010.62	1027.87	1044.34	1060.26	1098.53	1115.08	1132.25	1169.97	1185.81	300
320	1000.82	1018.46	1056.65	1074.30	1092.02	1109.04	1147.86	1164.95	1182.60	1220.79	1237.81	320
340	1044.81	1063.01	1102.37	1120.57	1138.05	1156.25	1195.62	1213.81	1232.00	1271.29	1288.89	340

PRICE GROUP 3      Deep

Width Drop cm	100cm	120cm	140cm	160cm	180cm	200cm	220cm	240cm	260cm	280cm	300cm	Width Drop cm
100	751.53	761.71	792.37	801.86	811.43	820.21	851.58	861.07	870.56	901.22	910.09	100
120	820.05	830.72	861.93	872.60	882.56	892.59	924.43	934.47	944.43	975.56	985.60	120
140	887.65	898.79	930.47	941.61	952.82	963.33	995.64	1006.15	1017.99	1049.67	1060.18	140
160	954.47	966.86	999.01	1011.33	1023.01	1034.07	1067.55	1078.53	1090.92	1123.08	1134.76	160
180	1022.07	1034.93	1068.26	1081.04	1092.57	1104.80	1138.76	1150.92	1163.78	1197.11	1209.34	180
200	1088.96	1102.92	1136.80	1150.13	1162.84	1175.54	1210.67	1223.38	1236.71	1270.51	1283.21	200
220	1157.42	1172.01	1206.28	1220.79	1234.04	1247.84	1282.82	1296.70	1310.58	1345.56	1358.73	220
240	1225.02	1240.00	1274.82	1289.88	1304.23	1318.58	1354.73	1369.08	1383.44	1418.96	1433.31	240
260	1291.92	1307.45	1344.07	1359.60	1374.42	1389.32	1425.94	1440.84	1457.00	1492.99	1507.89	260
280	1359.44	1375.44	1412.61	1428.61	1444.68	1460.05	1497.85	1513.22	1529.93	1566.39	1582.47	280
300	1426.33	1443.51	1481.15	1498.40	1514.87	1530.79	1569.06	1585.61	1602.78	1640.50	1656.34	300
320	1494.87	1512.52	1550.71	1568.35	1586.08	1603.09	1641.91	1659.01	1676.65	1714.85	1731.86	320
340	1562.40	1580.59	1619.96	1638.15	1655.64	1673.83	1713.20	1731.39	1749.59	1788.88	1806.48	340

All blinds are supplied unlined as standard, fabrics marked with an asterisk (\*) can be supplied with lining. We recommend that dim-out and black-out fabrics are lined to reduce pin holes. \*\*Due to the loose structure of weave we strongly recommend Multicolour Natura and Multicolour Panama are lined.

For Standard Lining add 10%, for Blackout Lining add 15% to the pricing tables above.

For electric operation, either with system SG 2345 Battery or SG 2350 Mains operation please add the difference in hardware cost to pricing tables above. If SG 2345 is being supplied with above fabrics, please check fabric weight is within system limitations.

SG 2345 Pricing example:      Made to measure Roman, using PG1 Fabric at 1.2m wide x 2m drop =      £608.87  
    Remove price of SG 2305 white hardware at 1.25m wide =      £91.45  
    Add on price for SG 2345 hardware at 1.25m wide =      £616.93  
    Total price =      £1134.35 (Category 'A')

All prices shown exclude VAT



# Panel Glide Systems

**SG 2700 (Hand)  
SG 2710 (Cord)  
Panel Glide**



**SG 2730  
Panel Flex**

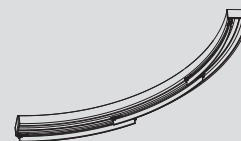

SG 2700/SG 2710 is delivered made to measure, ready assembled in **white**, top fix as standard. Panels either hang freely or can be connected and operated via a draw rod or cord at no extra cost.

SG 2730 is delivered made to measure, ready assembled in **white**. Panels either hang freely or can be connected and operated via a draw rod.

The systems are built up from different profiles with between 2 and 5 channels. Please consult the Silent Gliss catalogue to ensure you order the correct profile depending on how many panels and which stacking variation you require. Some technical restrictions apply.

Panels are usually between 50cm and 100cm and we recommend they overlap by approximately 10cm-15cm.

SG 2700 can be electrically operated in combination with SG 5600. For pricing, please add cost of 5600 Electric Track onto prices below. Please consult Silent Gliss for further information.

SG 2730 is only available as complete systems with fabric panels.

			Price Qty.				Price Qty.
<b>HARDWARE PRICES</b>			<b>C</b>	<b>HARDWARE PRICES</b>			<b>C</b>
SG 2700/SG 2710 – Straight Only				SG 2730 – Straight or Curved			
	<b>Manual</b>			<b>Manual</b>			
150cm	424.36			150cm	462.71		
200cm	533.17			200cm	601.60		
250cm	641.97			250cm	740.46		
300cm	750.78			300cm	879.32		
350cm	859.62			350cm	1018.22		
400cm	968.41			400cm	1157.07		
450cm	1077.22			450cm	1295.99		
500cm	1186.01			500cm	1434.83		
550cm	1292.74			550cm	1573.70		
600cm	1396.17			600cm	1712.59		
<b>PRICES PER FABRIC PANEL (max drop 3m)</b>				<b>PRICES PER FABRIC PANEL (max drop 3m)</b>			
	<b>Up to 60cm wide</b>	<b>60cm - 130cm wide</b>		<b>Up to 60cm wide</b>	<b>60cm - 130cm wide</b>		
Price Group 1	£292.26	£376.51		Price Group 1	£292.26	£376.51	
Price Group 2	£334.34	£436.74		Price Group 2	£334.34	£436.74	
Price Group 3	£433.70	£601.20		Price Group 3	£433.70	£601.20	
Price Group 4	£655.91	£870.68		Price Group 4	£655.91	£870.68	
<b>FABRIC SUITABILITY</b>				<b>FABRIC SUITABILITY</b>			
<b>Price Group 1</b>				<b>Price Group 1</b>	<b>Price Group 2</b>	<b>Price Group 3</b>	
Basic Screen 1%	Colorama 1 Multicolour			Colorama 1	Colorama 2	Colorama Dimout	
Basic Screen 5%	Colorama Acoustic			Colorama 1 Alu	Colorama 2 Bioactive		
Basic Screen 10%	Colorama Acoustic Multicolour			Colorama 1 Bioactive	Colorama 2 Eco		
Colorama 1	Element			Colorama 1 Eco	Colorama 2 Multicolour		
Colorama 1 Alu	Oscurante			Colorama 1 Multicolour	Leviso		
Colorama 1 Bioactive	Polyflax			Colorama Acoustic	Leviso Light		
Colorama 1 Eco	Someo			Colorama Acoustic Multicolour	Multicolour Natura		
	Valere			Oscurante	Multicolour Panama		
<b>Price Group 2</b>				Polyflax	Reflex		
Atracor	Multi Shadow	Reflex		Someo			
Colorama 2	Multi Visio	Safescreen		Valere			
Colorama 2 Bioactive	Multicolour Natura	Triscreen 1%					
Colorama 2 Eco	Multicolour Panama	Triscreen 3%					
Colorama 2 Multicolour	Multiscreen 1%	Triscreen 5%					
Leviso	Multiscreen 5%	Verascreen 1%					
Leviso Light	Multiscreen 10%	Verascreen 2%					
Mercurio	Newlifescreeen	Verascreen 5%					
Moon	Nox	Verascreen 10%					
<b>Price Group 3</b>							
Alutex	Newlifescreeen Alu						
Colorama Dimout	Multicolour Dimout						
<b>Price Group 4</b>							
Aluscreen Futura							
Deep							
Face fix brackets will carry an additional cost.				<b>BENDS</b>			<b>Max. trade discount 25%</b>
				For each bend add the following to the above system price			
				Angle bend	£588.00	Standard radius 15cm	
				Gradual curve	£944.00		
				<b>SG 2730</b>			
				10399 Design Fascia	£31.55 per metre, plus £4.70 per system		<b>A</b>
				<b>COLOURS</b>			
				Special colours not available			
<b>All prices shown exclude VAT</b>				<b>All prices shown exclude VAT</b>			



# Skylight Shading Systems

## SG 2190

**Crank Operated**  
For curved, sloping or horizontal Roman Blinds.

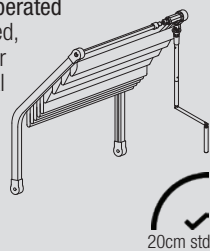

20cm std.

## SG 2195

**Electrically Operated**  
For curved, sloping or horizontal Roman blinds.

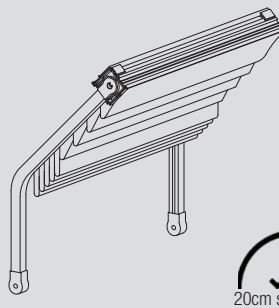

20cm std.

Made-to-measure Roman blinds for system 2190 and 2195

### SG 2190

#### Crank operated

##### Single System:

Max. width: 2.5m. Max. drop: 6m.

##### Double System:

Max. width: 3m. Max. drop: 6m.

These maximum sizes depend on the shape of system required – please check with Silent Gliss.

Max. fabric weight for both single/ double system: 10kg.

Prices below are for hardware only – for complete system cost please add price for fabric.

\*Cantilever option available for single systems. Please add 30%

##### \*Single System Prices

###### Silver or white

Width > Drop (cms)	Up to 100cm	101cm-150cm
150	1098.87	1165.13
200	1218.59	1284.88
250	1338.36	1404.65
300	1458.18	1524.41
350	1578.01	1644.27
400	1697.79	1764.09
450	1817.60	1883.86
500	1937.38	2003.61
550	2057.09	2082.96
600	2176.86	2243.18

Width > Drop (cms)	151cm-200cm	201cm-250cm
150	1231.40	1297.67
200	1351.18	1417.47
250	1470.96	1537.29
300	1590.80	1657.05
350	1710.58	1776.78
400	1830.32	1896.55
450	1950.10	2016.39
500	2069.86	2136.19
550	2189.75	2256.02
600	2309.46	2375.78

##### Double System Prices

###### Silver or white

If under 2500mm: Please add 30% to single system prices above.

Width > Drop (cms)	251cm-300cm	Width > Drop (cms)	251cm-300cm
150	1688.51	400	2430.13
200	1836.99	450	2578.47
250	1985.29	500	2726.81
300	2133.53	550	2875.07
350	2281.87	600	3023.50

### Components

3825 Clamp, 10, 100.

2189 Gear

2230 Endpiece, white or grey.

2759 Rod.

5130 Belt.

2242 Connector.

2746 Detachable crank handle.

2156 Drive shaft.

3181 Bracket (single clamp)

2139 Bracket (double clamp)

2248 Cross rod.

### Bending

Max. trade discount

Add the following to above system price:

Radius/cm	Single System	Double System
25-99	£359.00	£719.50
Over 99	£682.50	£1365.50

Standard angle radius 20cm.

All prices shown exclude VAT

Price Ctg.

C

### SG 2195 Electrically Operated

Total max. curtain weight 25kg. (including cross profiles). Max. width: 3m. Max. drop: 6m.

Max. total surface area 15m<sup>2</sup> depending on curtain weight.

System 2195 is also available as a double and treble system with 2190 as a slave system.

Max width achievable with double system: 6m, with treble system: 6m, other max. data as above.

Profile 2191 can be bent to a 20cm min. radius.

Supplied complete, hardware only, partially assembled including recessed switch and cross rods.

Profile as standard in silver or white. For complete system cost please add price for fabric.

See page 91 for Radio Control options.

\*Cantilever option available for single systems. Please add 30%

##### \*Single System Prices

###### Silver or White

Width > Drop (cms)	Up to 100cms	101cms-150cms	151cms-200cms	201cms-250cms	251cms-300cms
150	2974.73	3044.17	3113.65	3183.10	3252.53
200	3100.17	3169.69	3239.14	3308.62	3378.15
250	3225.73	3295.17	3364.61	3434.03	3503.52
300	3351.24	3420.62	3490.11	3559.57	3629.00
350	3476.72	3546.16	3615.60	3685.04	3754.49
400	3602.14	3671.62	3741.16	3810.57	3880.02
450	3727.66	3797.16	3866.62	3935.99	4005.46
500	3853.14	3922.61	3992.09	4061.53	4131.02
550	3978.68	4048.13	4117.59	4187.01	4256.55
600	4104.15	4173.60	4243.11	4312.54	4382.01

##### Double System Prices

Width > Drop (cms)	Up to 200cms	201 cms-300 cms	Silver or White 301cms-400cms	401cms-600cms
150	3714.79	3850.62	3986.38	4257.87
200	3960.11	4095.78	4231.67	4503.16
250	4205.41	4341.17	4476.97	4748.50
300	4450.72	4586.55	4722.24	4993.74
350	4695.95	4831.75	4967.49	5238.95
400	4941.27	5077.06	5212.75	5484.30
450	5186.49	5322.29	5458.04	5729.59
500	5431.79	5567.58	5703.34	5974.87
550	5677.06	5812.88	5948.57	6220.06
600	5922.42	6058.15	6193.85	6465.37

##### Treble System Prices

Width > Drop (cms)	Up to 300cms	301 cms-400 cms	Silver or White 401cms-500cms	501cms-600cms
150	4252.94	4454.97	4657.04	4758.12
200	4617.90	4820.06	5022.12	5123.10
250	4983.05	5185.20	5387.19	5488.19
300	5348.06	5550.10	5752.31	5853.27
350	5713.16	5915.21	6117.32	6218.38
400	6078.18	6280.28	6482.36	6583.37
450	6443.34	6645.35	6847.44	6948.44
500	6808.31	7010.46	7212.49	7313.53
550	7173.45	7375.54	7577.59	7678.58
600	7538.45	7740.53	7942.66	8043.63

### Components

3825 Clamp, 10, 100

2230 Set, white or grey

5130 Belt

2160 Motor

2759 Cross Rod

2242 Connector

2156 Drive Shaft

2248 Cross Rod

2145 Telescopic glider

3181 Bracket (single clamp) silver or white

2139 Bracket (double clamp) silver or white

### Bending

Max. trade discount

Add the following to above system price:

Radius/cm	Single System	Double System	Treble System
25-99	£359.00	£719.50	£1079.00
over 99	£682.50	£1365.50	£2059.50

Standard angle radius 20cm.

Price Ctg.

C

### Fabric for curved, sloping or horizontal Skylight Systems 2190/2195.

Made-to-measure Roman Blind for Systems 2190/2195.

Prices for made-up-blind, without hardware, per square metre.

Aluscreen Futura	£341.19 m <sup>2</sup>
Colorama Acoustic	£254.39 m <sup>2</sup>
Colorama Acoustic Multicolour	£254.39 m <sup>2</sup>
Colorama Dimout	£341.19 m <sup>2</sup>
Colorama 1	£213.99 m <sup>2</sup>
Colorama 1 Alu	£295.33 m <sup>2</sup>
Colorama 1 Bioactive	£254.39 m <sup>2</sup>
Colorama 1 Eco	£254.39 m <sup>2</sup>
Colorama 1 Multicolour	£254.39 m <sup>2</sup>
Colorama 2	£295.33 m <sup>2</sup>
Colorama 2 Bioactive	£295.33 m <sup>2</sup>
Colorama 2 Eco	£295.33 m <sup>2</sup>
Colorama 2 Multicolour	£295.33 m <sup>2</sup>
Levisio Light	£254.39 m <sup>2</sup>
Multicolour Natura	£295.33 m <sup>2</sup>
Multiscreen 5%	£318.26 m <sup>2</sup>
Multiscreen 10%	£318.26 m <sup>2</sup>
Oscurante	£254.39 m <sup>2</sup>
Reflex	£234.19 m <sup>2</sup>
Triscreen 1%	£318.26 m <sup>2</sup>
Triscreen 3%	£318.26 m <sup>2</sup>
Triscreen 5%	£318.26 m <sup>2</sup>
Versascreen 5%	£318.26 m <sup>2</sup>
Versascreen 10%	£318.26 m <sup>2</sup>

Price Ctg.

C



# Skylight Shading Systems

## SG 8600

Electrically Operated  
tension roller blind.

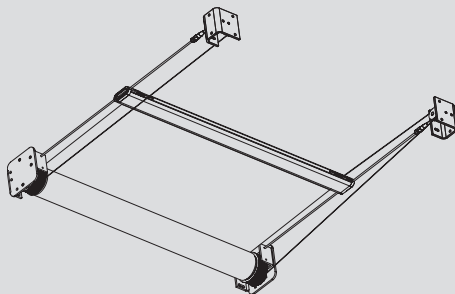

### SG 8600

Electrically operated tensioned roller blind system.  
Max. width: 4m. Max. drop: 6.5m

#### SG 8600 with Basicscreen 5% / Multiscreen 5% / Versascreen 5%

Price Category 'C'

Width Drop	110cm	150cm	200cm	250cm	300cm	350cm	400cm	Width Drop
100	3669.46	3705.18	3961.81	3998.06	4246.40	4291.02	4335.63	100
150	3707.26	3756.67	4030.48	4083.87	4349.42	4430.01	4472.94	150
200	3744.99	3808.14	4099.12	4169.72	4452.33	4531.35	4610.26	200
250	3782.76	3859.67	4167.78	4255.50	4555.37	4651.49	4747.62	250
300	3820.53	3911.11	4236.43	4341.34	4658.33	4771.66	4884.93	300
350	4022.33	4126.68	4460.83	4591.31	4929.53	5055.79	5186.25	350
400	4060.06	4178.17	4529.47	4677.11	5070.22	5175.96	5323.59	400
450	4097.81	4229.65	4598.13	4762.95	5131.35	5296.13	5460.90	450
500	4135.59	4281.17	4666.82	4848.78	5234.30	5416.26		500
550	4173.34	4332.65	4735.47	4934.59	5337.30	5536.40		550
600	4211.13	4384.16	4804.15	5020.44	5440.24			600
650	4248.88	4435.61	4872.80	5106.23	5543.26			650

#### SG 8600 with Aluscreen Futura / Safescreen

Price Category C

Width Drop	110cm	150cm	200cm	250cm	300cm	350cm	400cm	Width Drop
100	3708.70	3758.69	4033.10	4087.62	4353.37	4416.22	4478.26	100
150	3761.53	3830.67	4129.18	4207.24	4497.43	4583.95	4670.42	150
200	3814.41	3902.76	4225.26	4327.39	4641.59	4752.08	4862.57	200
250	3867.24	4016.71	4321.33	4405.61	4785.67	4920.21	5054.77	250
300	3920.05	4046.88	4417.41	4567.60	4929.83	5088.14	5246.88	300
350	4136.89	4283.00	4669.25	4851.77	5237.95	5420.94	5603.06	350
400	4189.76	4355.08	4765.73	4971.86	5382.08	5588.63	5795.20	400
450	4242.62	4427.10	4861.40	5091.94	5526.22	5756.75	5987.37	450
500	4295.47	4499.12	4957.47	5212.10	5670.30	5924.93		500
550	4348.30	4571.24	5053.55	5332.17	5814.45	6093.07		550
600	4443.02	4643.27	5149.62	5452.31	5958.54			600
650	4453.99	4715.30	5245.67	5572.38	6102.66			650

Motor is fitted as standard to the left. Should you require a right hand motor there will be an additional cost of £261.78.

Profiles are standard in white (RAL 9016). Alternative standard RAL colours are available at a cost of £391.96 (per system, nett, Cat E).

All prices shown exclude VAT





# Skylight Shading Systems

## SG 8640

Electrically Operated  
Tensioned roller blind with  
fabric edge retention.

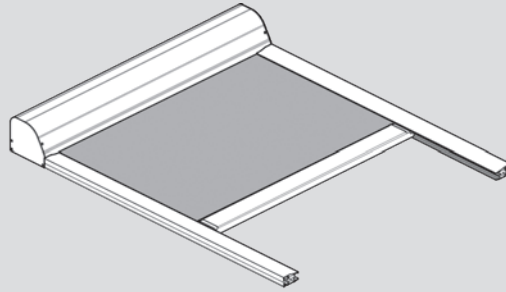

### SG 8640

Minimum width 650mm. Max width 3000mm  
Maximum length 4500mm. Systems over 3000mm length use a larger barrel & headbox.  
Please see catalogue for sizing limitations.

\*Width restrictions apply, see below.

Price Group 1 – Multiscreen 1% / 5% and Versascreen 1% / 5% (for blackout fabric options please consult Silent Gliss)

Price Category 'C'

Width Drop ▼	100cm	150cm	200cm	250cm	300cm	Width Drop ▼
150	4820.24	5234.01	5473.32	5862.37	6101.67	150
200	5129.52	5623.08	5942.13	6410.96	6730.03	200
250	5289.06	5862.37	6261.21	6809.81	7208.62	250
300	5448.59	6101.67	6580.27	7208.62	7687.24	300
350	5757.89	6490.72	7049.09	7757.21	8315.58	350
400	5917.42	6730.03	7368.16	8156.07	8794.17	400
450	6076.97	6969.32	7687.24	8554.88	9272.79	450

Price Group 2 – Aluscreen Futura (for blackout fabric options please consult Silent Gliss)

Width Drop ▼	100cm	150cm	200cm	250cm	300cm	Width Drop ▼
150	4913.44	5373.82	5659.70	6095.38	6381.27	150
200	5253.78	5809.46	6190.66	6721.60	7674.61	200
250	5420.16	6095.38	6571.85	7198.12	7674.61	250
300	5634.99	6381.27	6953.06	7674.61	8246.41	300
350	5975.35	6816.92	7484.00	8300.85	8967.95	350
400	6165.93	7102.82	7865.34	8777.36	9539.75	400
450	6356.55	7388.71	8246.41	9253.85	10111.55	450

3.0 x 3.0m max in any orientation.

\*Max 2.5m wide x 4.5m long / 11m<sup>2</sup> greater than 30° from vertical.

White Hardware available as standard (RAL 9016 white). Alternative standard RAL colours are available at a cost of £391.96 (per system, nett, Cat E).

For use with remote, please see page 28 for external receivers and remote control options. Details on compatible receivers and remotes can be found on page 91–92.

All prices shown exclude VAT



# Vertical Blind Systems

## Vertical Waves by Eva Marmbrandt

## SG 2810

Profile only 2601 available in 6 metre lengths.  
Headrail available in silver and white.

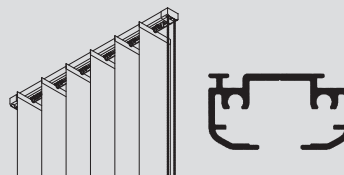

Suitable for use on systems 2810, 2900, 2950. Not applicable for sloping systems.

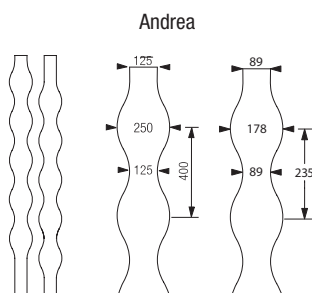

**Vertical Waves**  
**Fabric Price Group 2**  
Made in Multi Visio and Multi Shadow

Minimum and maximum system length as per individual system information.  
Minimum louvre drop 104cm (127mm)  
Maximum louvre drop 423cm (127mm)

Minimum louvre drop 110cm (89mm)  
Maximum louvre drop 364cm (89mm)

Minimum distance from wall 140mm  
Can be bent to large radius >6m.

Available as 89mm or 127mm louvres.

**3D Vertical Wave**  
**Fabric Price Group 3 + 20% + Set up charge**  
Made in Multi Visio  
Drop must be between 2.18m-2.97m

## SG 2810

Track and Accessories only

**Maximum system width 5m (127mm) or 3.8m (89mm).**

For guidance the following number of louvres per metre should be calculated:  
127mm/5" 10/metre  
89mm/3 1/2" 13/metre

**Track system only complete, assembled, ready to hang.**

Hardware only: in silver or white, no fabrics. Excluding bottom weights and link chain but including Top clips and 2616 bracket clamps. Operating chain 150cm standard. Wall fix brackets extra. Prices given are for 127mm/5" louvres. For 89mm/3 1/2" louvres add 15%.

Width up to cm	£	Price Ctg.
60	130.69	C
80	154.90	
100	179.13	
120	203.36	
140	227.53	
160	251.71	
180	275.86	
200	300.07	
220	324.27	
240	348.50	
260	372.54	
280	396.82	
300	421.03	
320	445.20	
340	469.42	
360	493.61	
380	517.74	
400	541.96	
420	566.18	
440	590.42	
460	614.62	
480	638.87	
500	663.12	

### Standard Accessories

- 2601 Profile only, silver or white.
- 2604 Guide.
- 2605 Top clip 127mm white.
- 2608 Endstop for 2601.
- 2610 Endstop.
- 2611 Stopper.
- 2616 Bracket.
- 2620 Pilot runner.
- 2623 Rotation element (123mm).
- 2625 Rotation element (89mm).
- 2813 Top clip 89mm white.
- 2865 Bead chain connector.
- 2872 Plastic operating chain.
- 10731 Cord tidy

	Price Ctg.		Price Ctg.
<b>Optional Accessories</b> (Additional Charges May Apply) 2471 Bottom weight 127mm. 2473 Bottom weight 89mm. 2479 Louvre connecting chain 127mm. 2481 Louvre connecting chain 89mm. 2614 Recess profile. 2615 Recess profile. 2618 Shaft. 2624 Adjustment element (101mm). 2824 Spacer (65mm). 5118 Wedge. 2872 Operating chain black Smart Fix Bracket Covers	C		E
11116 Smart Fix Bracket Cover. 11137 Square Smart Fix Bracket Cover.	A	<b>*3D Vertical Waves</b> £471.50 set up charge. Please add to assembled prices Made in Multi Visio 127mm Andrea Design only.	
<b>Smart Fix Brackets in white, black or silver</b> 11119 Smart Fix 80mm Bracket (11201 Set). 11120 Smart Fix 100mm Bracket (11202 Set). 11121 Smart Fix 120mm Bracket (11203 Set). 11122 Smart Fix 150mm Bracket (11204 Set). 11123 Smart Fix 200mm Bracket (11205 Set).		<b>Printing Information</b> All RAL colours applicable (except white, pearl and fluorescent colours). Height 218cm to 297cm 5 shape louvre and 6 shape louvre.	
<b>Square Smart Fix Brackets in white, black or silver</b> 11140 Smart Fix 80mm Bracket (11211 Set). 11141 Smart Fix 100mm Bracket (11212 Set). 11142 Smart Fix 120mm Bracket (11213 Set). 11143 Smart Fix 150mm Bracket (11214 Set). 11144 Smart Fix 200mm Bracket (11215 Set).		<b>Fabric price categories</b> For SG 2810 complete with fabrics (see tables over)	
<b>Bends</b> Max trade discount	25%	<b>Price Group 1</b> Element Function Multi Shadow Multi Visio	
Radius/cm Profile 2601 75 £109.50 Standard angle bend radius Over 75 £225.50		<b>Price Group 2</b> Alutex Colorama 2 Mercurio Multiscreen 5% Versascreen 1% Versascreen 2% Versascreen 5% Versascreen 10% Vertical Wave (Multi Visio, Multi shadow)	
		<b>Price Group 3</b> Colorama 2 Bioactive Moon Reflex 3D Vertical Wave (Multi Visio)* + 20% + Set up charge	
		All fabrics are available in 89mm and 127mm louvres (89mm add 15%). All above fabrics are FR.	

All prices shown exclude VAT



# SG 2810 complete with fabric

The prices below comprise complete system, silver or white ready-to-hang, top fix, single or pair stack with fabric choice in 127mm/5" louvres (see fabric price categories). Includes bottom weights and bottom link cord to both sides. Wall fix brackets extra. For 89mm/3 1/2" louvres add 15%. If sizes lie between the measurements shown, the price for the next larger will apply. Set up costs apply for 3D vertical waves.

Price Category C												
Width cm	UP TO 60			UP TO 80			UP TO 100			UP TO 120		
Drop cm	1	2	3	1	2	3	1	2	3	1	2	3
60	184.58	207.41	232.02	226.75	257.08	289.96	268.88	306.82	347.92	310.99	356.51	405.86
80	192.87	223.21	256.04	237.75	278.17	321.98	282.59	333.13	387.90	327.49	388.15	453.86
100	201.06	238.94	280.04	248.68	299.24	354.00	296.26	359.53	427.09	343.92	419.78	501.90
120	209.31	254.77	304.07	259.67	320.31	385.99	309.99	385.84	468.00	360.35	451.38	549.95
140	217.52	270.61	328.12	270.61	341.37	418.10	323.66	412.16	508.07	376.74	482.92	598.05
160	225.71	286.38	352.16	281.50	362.46	450.08	337.39	438.49	548.05	393.18	514.55	646.08
180	233.95	302.19	376.09	292.48	383.42	482.13	351.05	464.85	588.07	409.65	546.12	694.10
200	242.13	318.01	400.16	303.40	404.59	514.17	364.80	491.10	628.15	426.16	577.80	742.14
220	250.34	333.76	424.20	314.42	425.67	546.14	378.48	517.52	668.18	442.52	609.38	790.13
240	258.58	349.66	448.27	325.42	446.74	578.21	392.17	543.88	708.28	458.90	640.95	838.20
260	266.76	365.45	472.21	336.32	467.81	610.26	405.88	570.21	748.32	475.33	672.58	886.28
280	275.03	381.17	496.25	347.23	488.82	642.33	419.55	596.55	788.32	491.83	704.20	934.29
300	283.21	397.04	520.29	358.25	509.88	674.36	433.26	622.88	828.31	508.29	735.82	982.39
320	291.45	412.80	544.38	369.26	531.00	706.28	446.94	649.20	868.40	524.72	767.38	1030.45
340	299.70	428.57	568.32	380.19	552.05	738.36	460.66	675.50	908.38	541.15	798.93	1078.49
360	307.89	444.42	592.33	391.18	573.11	770.39	474.35	701.88	948.49	557.56	830.61	1126.55
380	316.14	460.22	616.38	402.04	594.17	802.43	488.06	728.19	988.46	574.05	862.26	1174.55
400	324.31	476.02	640.36	413.02	615.24	834.48	501.76	754.55	1028.51	590.47	893.78	1222.55

Width cm	UP TO 140			UP TO 160			UP TO 180			UP TO 200		
Drop cm	1	2	3	1	2	3	1	2	3	1	2	3
60	353.17	406.23	463.77	395.26	455.97	521.68	437.44	505.73	579.66	479.59	555.40	637.61
80	372.33	443.06	519.84	417.25	498.10	585.76	462.07	553.03	651.72	507.03	608.13	717.69
100	391.58	480.09	575.87	439.12	540.28	649.80	486.76	600.49	723.78	534.31	660.75	797.75
120	410.70	516.86	631.91	461.05	582.43	713.92	511.40	647.93	795.84	561.73	713.45	877.84
140	429.83	553.70	687.91	482.93	624.52	777.95	536.01	695.36	867.87	589.18	766.13	957.92
160	449.07	590.65	744.01	504.90	666.66	841.97	560.69	742.76	940.04	616.60	818.82	1037.92
180	468.18	627.49	800.08	526.80	708.83	906.06	585.39	790.09	1012.07	643.98	871.44	1117.97
200	487.39	664.38	856.16	548.71	750.94	970.12	610.01	837.54	1084.13	671.37	924.09	1198.13
220	506.56	701.25	912.17	570.67	793.08	1034.17	634.62	884.98	1156.21	698.71	976.84	1278.17
240	525.73	738.08	968.23	592.60	835.30	1098.27	659.36	932.42	1228.20	726.10	1029.50	1358.28
260	544.94	774.99	1024.22	614.48	877.38	1162.29	683.99	979.84	1300.31	753.50	1082.14	1438.36
280	564.11	811.87	1080.35	636.36	919.47	1226.37	708.60	1027.19	1372.36	780.95	1134.81	1518.41
300	583.30	848.74	1136.39	658.24	961.61	1290.40	733.30	1074.61	1444.39	808.32	1187.49	1598.46
320	602.51	885.65	1192.41	680.16	1003.77	1354.48	757.97	1122.04	1516.54	835.65	1240.24	1678.56
340	621.61	922.45	1257.35	702.17	1046.02	1418.58	782.68	1169.43	1588.58	863.12	1292.94	1758.67
360	640.81	959.38	1304.54	724.06	1088.08	1482.62	807.31	1216.88	1660.67	890.52	1345.52	1838.70
380	659.98	996.26	1360.59	746.00	1130.22	1546.68	831.94	1264.17	1732.70	917.96	1398.26	1918.77
400	679.21	1033.14	1416.62	767.87	1172.38	1610.69	856.58	1311.61	1804.77	945.29	1450.93	1940.59

Width cm	UP TO 220			UP TO 240			UP TO 260			UP TO 280		
Drop cm	1	2	3	1	2	3	1	2	3	1	2	3
60	521.66	605.14	695.54	563.77	654.83	753.45	605.98	704.55	811.36	648.10	754.28	869.35
80	551.88	663.05	783.64	596.74	718.04	849.57	641.50	773.03	915.49	686.51	827.99	981.48
100	581.95	721.01	871.65	629.62	781.26	945.58	677.16	841.55	1019.51	724.87	901.75	1093.58
120	612.11	778.96	959.80	662.45	844.50	1041.73	712.86	910.03	1123.74	763.16	975.49	1205.69
140	642.27	836.91	1047.86	695.36	907.68	1137.81	748.44	978.48	1227.77	801.52	1049.28	1317.75
160	672.35	894.83	1135.94	728.19	970.90	1233.89	784.06	1046.90	1331.86	839.88	1123.03	1429.88
180	702.51	952.81	1223.99	761.10	1034.07	1330.01	819.68	1115.41	1435.96	878.20	1196.79	1541.99
200	732.65	1010.76	1312.15	793.97	1097.32	1426.08	855.26	1183.86	1540.11	916.51	1270.49	1654.04
220	762.73	1068.75	1400.17	826.87	1160.57	1522.12	890.85	1252.44	1644.12	954.96	1344.33	1766.16
240	792.90	1126.62	1488.28	859.71	1223.72	1618.29	926.55	1320.87	1748.25	993.28	1418.04	1878.21
260	823.00	1184.55	1576.26	892.62	1286.93	1714.37	962.11	1389.35	1852.41	1031.65	1491.74	1990.33
280	853.19	1242.51	1664.39	925.42	1350.20	1810.45	997.77	1457.81	1956.43	1069.95	1565.46	2102.50
300	883.37	1300.48	1752.51	958.36	1413.40	1906.50	1033.33	1526.37	2060.56	1108.35	1639.23	2214.53
320	913.45	1358.42	1840.52	991.19	1476.61	2002.58	1068.99	1594.85	2164.61	1146.70	1713.01	2326.66
340	943.67	1416.34	1928.64	1024.11	1539.78	2098.70	1104.59	1663.30	2268.72	1185.07	1786.74	2438.78
360	973.71	1474.28	2016.73	1057.00	1603.01	2194.83	1140.20	1731.71	2372.87	1223.39	1860.50	2550.86
380	1003.86	1532.26	2104.78	1089.84	1666.21	2290.84	1175.81	1800.23	2476.90	1261.80	1934.27	2663.00
400	1033.99	1590.18	2192.84	1122.75	1729.46	2386.99	1211.50	1868.70	2581.00	1300.13	2007.97	2775.07

All prices shown exclude VAT



# SG 2810 complete with fabric

The prices below comprise complete system, silver or white ready-to-hang, top fix, single or pair stack with fabric choice in 127mm/5" louvres (see fabric price categories). Includes bottom weights and bottom link cord to both sides. Wall fix brackets extra. For 89mm/3 1/2" louvres add 15%. If sizes lie between the measurements shown, the price for the next larger will apply. Set up costs apply for 3D vertical waves.

Price Category C

Width cm	UP TO 300			UP TO 320			UP TO 340			UP TO 360		
	1	2	3	1	2	3	1	2	3	1	2	3
Drop cm												
60	690.22	804.07	927.32	732.36	853.75	985.21	774.56	903.43	1043.10	816.60	953.12	1101.11
80	731.34	883.03	1047.41	776.23	937.96	1113.32	821.06	992.97	1179.32	865.96	1047.97	1245.22
100	772.40	962.08	1167.53	820.07	1022.31	1241.46	867.71	1082.55	1315.40	915.21	1142.77	1389.35
120	813.50	1041.04	1287.58	863.80	1106.57	1369.61	914.23	1172.08	1451.47	964.61	1237.62	1533.52
140	854.64	1120.06	1407.72	907.73	1190.79	1497.70	960.78	1261.70	1587.64	1013.89	1332.46	1677.57
160	895.70	1199.12	1527.81	951.50	1275.10	1625.79	1007.39	1351.16	1723.78	1063.23	1427.20	1821.74
180	936.85	1278.11	1647.89	995.46	1359.36	1753.86	1053.92	1440.74	1859.95	1112.50	1522.08	1965.85
200	977.87	1357.09	1768.00	1039.21	1443.71	1882.08	1100.57	1530.29	1996.09	1161.87	1616.88	2109.99
220	1019.06	1436.10	1888.22	1083.01	1527.99	2010.16	1147.13	1619.87	2132.17	1211.15	1711.68	2254.30
240	1060.11	1515.09	2008.30	1126.93	1612.26	2138.44	1193.71	1709.38	2268.26	1260.48	1806.56	2398.31
260	1101.22	1594.15	2128.40	1170.76	1696.53	2266.41	1240.28	1798.93	2404.44	1309.75	1901.33	2542.43
280	1142.27	1673.10	2248.52	1214.62	1780.83	2394.52	1286.80	1888.49	2540.51	1359.11	1996.16	2686.57
300	1183.40	1752.14	2368.60	1258.33	1865.12	2522.66	1333.41	1978.07	2676.74	1408.38	2090.94	2830.71
320	1224.48	1831.20	2488.72	1302.18	1949.34	2650.77	1379.90	2067.60	2812.75	1457.70	2185.79	2974.79
340	1265.59	1910.18	2608.79	1346.11	2033.65	2778.86	1426.54	2157.15	2948.90	1507.08	2280.63	3118.97
360	1306.66	1989.27	2728.94	1389.88	2117.94	2906.99	1473.15	2246.68	3084.95	1556.33	2375.43	3263.07
380	1347.72	2068.24	2849.07	1433.76	2202.23	3035.06	1519.66	2336.16	3221.15	1605.71	2470.28	3407.22
400	1388.88	2147.21	2969.13	1477.56	2286.54	3163.19	1566.23	2425.84	3357.23	1654.99	2565.05	3551.32

Width cm	UP TO 380			*UP TO 400			*UP TO 420			*UP TO 440		
	1	2	3	1	2	3	1	2	3	1	2	3
Drop cm												
60	858.78	1002.86	1159.03	900.92	1052.57	1216.97	943.13	1102.33	1274.86	985.16	1152.03	1332.85
80	910.85	1102.97	1311.25	955.66	1157.97	1377.13	1000.60	1212.95	1443.02	1045.44	1267.90	1509.06
100	962.94	1203.06	1463.35	1010.47	1263.32	1537.29	1058.12	1323.56	1611.21	1105.74	1383.83	1685.19
120	1014.95	1303.15	1615.47	1065.31	1368.62	1697.37	1115.64	1434.14	1779.37	1165.99	1499.71	1861.35
140	1067.06	1403.25	1767.59	1120.07	1474.00	1857.50	1173.17	1544.75	1947.51	1226.31	1615.56	2037.52
160	1119.05	1503.29	1919.72	1174.89	1579.32	2017.68	1230.71	1655.47	2115.73	1286.56	1731.46	2213.66
180	1171.09	1603.39	2071.83	1229.69	1684.71	2177.81	1288.22	1766.00	2283.88	1346.80	1847.37	2389.84
200	1223.16	1703.44	2224.00	1284.45	1790.03	2337.97	1345.75	1876.72	2452.01	1407.13	1963.24	2565.72
220	1275.23	1803.61	2376.17	1339.26	1895.36	2498.14	1403.35	1987.31	2619.97	1467.35	2079.13	2742.06
240	1327.34	1903.69	2528.32	1394.03	2000.75	2658.30	1460.85	2097.84	2788.27	1527.63	2194.98	2918.31
260	1379.33	2003.73	2680.45	1448.82	2106.06	2818.41	1518.41	2208.58	2956.47	1587.91	2310.91	3094.45
280	1431.36	2103.80	2832.56	1503.66	2211.47	2978.60	1575.98	2319.13	3124.65	1648.20	2426.81	3270.60
300	1483.46	2203.86	2984.68	1558.38	2249.30	3138.73	1633.40	2429.75	3292.77	1708.45	2542.64	3446.78
320	1535.48	2303.98	3136.82	1613.17	2422.21	3298.94	1690.95	2540.41	3460.89	1768.60	2658.55	3622.97
340	1587.54	2404.10	3288.94	1668.04	2527.55	3459.07	1748.45	2650.96	3629.11	1828.97	2774.47	3799.09
360	1639.63	2504.19	3441.14	1722.81	2632.91	3619.17	1806.05	2761.73	3797.25	1889.26	2890.42	3975.27
380	1691.64	2604.32	3593.28	1777.59	2738.23	3779.32	1863.50	2872.22	3965.38	1949.52	3006.25	4151.39
400	1743.69	2704.28	3745.36	1832.37	2843.63	3939.47	1921.09	2982.84	4133.58	2009.86	3122.11	4327.61

Width cm	*UP TO 460			*UP TO 480			*UP TO 500		
	1	2	3	1	2	3	1	2	3
Drop cm									
60	1027.33	1201.75	1390.78	1069.49	1251.44	1448.70	1111.60	1301.20	1506.64
80	1090.28	1322.87	1574.92	1135.14	1377.88	1640.90	1180.03	1432.83	1706.81
100	1153.34	1444.11	1759.14	1200.95	1504.36	1833.09	1248.59	1564.57	1907.06
120	1216.40	1565.24	1943.23	1266.66	1630.77	2025.21	1317.05	1696.28	2107.17
140	1279.29	1686.34	2127.49	1332.44	1757.13	2217.47	1385.48	1827.90	2307.41
160	1342.34	1807.58	2311.66	1398.26	1883.60	2409.58	1454.05	1959.62	2507.57
180	1405.38	1928.64	2495.90	1463.95	2009.96	2601.87	1522.55	2091.28	2707.86
200	1468.41	2049.89	2680.02	1529.74	2136.48	2794.06	1591.04	2223.07	2908.03
220	1531.41	2170.97	2863.95	1595.53	2262.80	2985.99	1659.54	2354.65	3107.80
240	1594.44	2292.18	3048.23	1661.23	2389.28	3178.29	1728.01	2486.40	3308.22
260	1657.52	2413.36	3232.47	1727.01	2515.73	3370.42	1796.59	2618.15	3508.47
280	1720.52	2534.44	3416.67	1792.73	2642.10	3562.72	1865.03	2749.80	3708.70
300	1783.45	2655.61	3600.79	1858.47	2768.44	3754.83	1933.50	2881.48	3908.87
320	1846.42	2776.76	3784.93	1924.16	2894.96	3947.02	2001.92	3013.13	4109.00
340	1909.43	2897.93	3969.17	1989.95	3021.39	4139.16	2070.40	3144.91	4309.21
360	1972.54	3019.17	4153.38	2055.74	3147.86	4331.41	2138.98	3276.62	4509.44
380	2035.50	3140.23	4337.53	2121.43	3274.29	4523.57	2207.37	3408.25	4709.65
400	2098.54	3261.43	4521.59	2187.25	3400.70	4715.71	2275.99	3539.96	4909.75

\*127mm louvre only

All prices shown exclude VAT



# Vertical Blind Systems

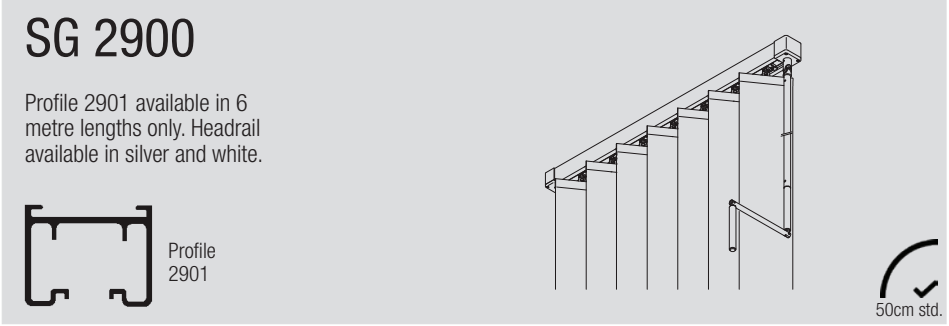
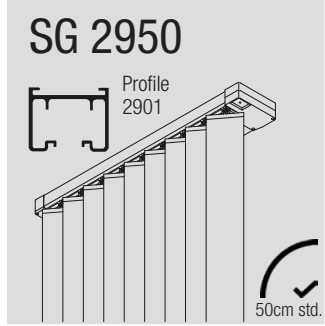

**SG 2950**  
**Electrically Operated Vertical Blind System**  
 Track system complete, assembled, ready to hang.  
 Min. system width: 110cm  
 Max. system width: 600cm  
 Available in 127mm and 89mm systems.  
 Supplied with recess switch 0565 for open/close/tilt operation. Sloping 2950's must have the motor at the top of the slope. Silver or white at same cost.

	Price Ctgy.
<b>Pricing for SG 2950</b> Add to relevant hardware or hardware and fabric price over:	<b>C</b>
2950 £941.88	
2950R £1252.73 (Integrated Receiver)	

SG 0450 Radio Controls is also suitable for use with SG 2950.

	Price Ctgy.
<b>Accessories</b> 2901 Profile, silver or white. 9117 Set. 2912 Belt. 2925 Belt connector. 2927 Pilot runner. 3033 Clamp. 9091 Motor	<b>C</b>

Bends	Max. trade discount	25%
Radius cm	Profile 2901	
50-99	£176.50	
Standard angle bend radius 50cm		
Over 99	£337.00	

Colours	Price Ctgy.
Other colours special order – see page 73.	<b>E</b>

**Pricing Examples** 2950 200cm width, straight hardware only:  
 2900 +per system  
 £711.25 +£941.88  
 = £1653.13  
 Note: Price based on 127mm/5" system.

All prices shown exclude VAT

**SG 2900**  
**Track and Accessories only**  
 Track system only complete, assembled, ready to hang.  
 Min. system width: 50cm  
 Max. system width: 600cm

Width up to cm	£	Width up to cm/ft.ins.	£
120	513.03	300	958.90
140	562.58	320	1008.43
160	612.16	340	1057.94
180	661.70	360	1107.56
200	711.25	380	1157.06
220	760.77	400	1206.60
240	810.33	420	1256.17
260	859.91	440	1305.66
280	909.31	460	1355.17

	Price Ctgy.
<b>Accessories</b> 2605 Top clip 127mm each, white. 2813 Top clip 89mm each, white. 2735 Nylon weight hook, each, 100. 2746 Detachable crank handle (standard). 2824 Endstop, each, 10. 2471 Bottom weight 127mm. 2473 Bottom weight 89mm. 2479 Bottom link cord 127mm. 2481 Bottom link cord 89mm. 2901 Profile, per metre. 2912 Drive belt. 2916 Rotation element 127 mm. 2918 Rotation element 89mm. 2920 Endpiece set, white or grey. 2925 Belt Connector. 2927 Pilot runner, each 3033 Clamps set of 10, 100. 2849 Top clip for PVC per 100. 2962 Connecting bridge.	<b>C</b>

	Price Ctgy.
2671 Bottom weight 89mm without horns. 2672 Bottom weight 127mm without horns. 1148C Screw 31mm/1 1/4" No. 8 counter sunk, 100.  Universal Smart Fix Extension Bracket in white, black or silver 11154 Universal Smart Fix 120mm. 11155 Universal Smart Fix 150mm. 11156 Universal Smart Fix 200mm.	<b>A</b>

Hardware only, no fabric.  
 Excluding bottom weight and link cord but including 2605 top clips and 3033 top fix clamps.  
 Operating handle 150cm drop as standard. Wall fixing brackets extra (see below) Prices given are for 127mm/5" louvres.  
 Sloping window+50%. For 89mm/3 1/2" louvres, add 15%.  
 Silver or white at same cost.

**\*3D Vertical Waves**  
 £471.50 set up charge.  
 Please add to assembled prices.  
 Made in Multi Visio Colour 1  
 127mm Andrea Design only.  
**Printing Information**  
 All RAL colours applicable (except white, pearl and fluorescent colours). Height 218cm to 297cm  
 5 shape louvre and 6 shape louvre.

**Fabric price categories**  
 For SG 2900 complete with fabrics (see tables over)

Price Group 1	Price Ctgy.
Element Function Multi Shadow Multi Visio	<b>E</b>

Price Group 2	Price Ctgy.
Alutex Colorama 2 Mercurio Multiscreen 5% Versascreen 1% Versascreen 2% Versascreen 5% Versascreen 10% Vertical Wave (excl. sloping systems)	<b>E</b>

Price Group 3	Price Ctgy.
Colorama 2 Bioactive Moon Reflex 3D Vertical Wave (Multi Visio)* + 20% + set up charge.	<b>E</b>

All fabrics are available in 89mm and 127mm louvres (89mm add 15%).  
 All above fabrics are FR





# SG 2900 complete with fabric

The prices below comprise complete system, silver or white ready-to-hang, top fix, single or pair stack with fabric choice in 127mm/5" louvres (see fabric price categories). Includes bottom weights and bottom link cord to both sides, 150cm drop operating crank handle. Wall fix brackets extra. For 89mm/3 1/2" louvres add 15%. If sizes lie between the measurements shown, the price for the next larger size will apply. Set up costs apply for 3D vertical waves.

Price Category C

Width cm	UP TO 120			UP TO 140			UP TO 160		
	1	2	3	1	2	3	1	2	3
Drop cm									
60	651.19	696.65	746.02	714.90	767.96	825.56	778.54	839.20	904.99
80	667.64	728.26	794.04	734.05	804.79	881.62	800.47	881.31	969.02
100	684.03	759.96	842.12	753.29	841.72	937.65	822.38	923.55	1033.13
120	700.53	791.49	890.04	772.40	878.55	993.65	844.29	965.69	1097.19
140	716.91	823.11	938.23	791.56	915.45	1049.69	866.20	1007.79	1161.20
160	733.35	854.71	986.23	810.74	952.36	1105.75	888.14	1049.93	1225.20
180	749.82	886.34	1034.26	829.97	989.18	1161.86	910.06	1092.11	1289.29
200	766.25	917.98	1082.33	849.09	1026.13	1217.86	931.96	1134.18	1353.34
220	782.76	949.46	1130.33						
240	799.17	981.06	1178.41	868.34	1062.99	1273.88	953.91	1176.40	1417.46
260	815.51	1012.81	1226.42	887.44	1099.79	1329.98	975.86	1218.51	1481.52
280	831.99	1044.36	1274.51	906.60	1136.72	1386.01	997.73	1260.67	1545.59
300	848.47	1076.02	1322.55	925.82	1173.54	1442.04	1019.63	1302.81	1609.67
320	864.89	1107.58	1370.58	944.96	1210.46	1498.12	1041.46	1344.92	1673.62
340	881.29	1139.17	1418.64	964.20	1247.37	1554.14	1063.45	1387.03	1737.76
360	897.71	1170.78	1466.67	983.36	1284.15	1610.21	1085.41	1429.30	1801.81
380	914.21	1202.37	1514.71	1002.53	1321.10	1666.26	1107.28	1471.39	1865.86
400	930.65	1233.98	1562.75	1021.72	1357.89	1722.32	1129.26	1513.54	1929.97
				1040.87	1394.82	1778.41	1151.16	1555.64	1993.97

Width cm	UP TO 180			UP TO 200			UP TO 220		
	1	2	3	1	2	3	1	2	3
Drop c									
60	842.25	910.53	984.45	905.99	981.73	1063.95	969.58	1053.04	1143.42
80	866.86	957.92	1056.48	933.31	1034.44	1144.13	999.76	1111.04	1231.50
100	891.49	1005.32	1128.59	960.65	1087.07	1224.05	1029.87	1168.94	1319.62
120	916.22	1052.66	1200.64	988.10	1139.80	1304.16	1060.01	1226.83	1407.70
140	940.87	1100.15	1272.73	1015.53	1192.42	1384.26	1090.15	1284.85	1495.78
160	965.49	1147.52	1344.79	1042.92	1245.17	1464.34	1120.23	1342.74	1583.80
180	990.15	1194.96	1416.90	1070.31	1297.84	1544.38	1150.41	1400.75	1671.90
200	1014.83	1242.33	1488.91	1097.75	1350.45	1624.47	1180.54	1458.63	1760.01
220	1039.53	1289.77	1560.95	1125.11	1403.21	1704.54	1210.67	1516.59	1848.08
240	1064.13	1337.22	1633.10	1152.51	1455.81	1784.61	1240.83	1574.54	1936.13
260	1088.82	1384.57	1705.09	1179.89	1508.58	1864.65	1271.01	1632.46	2024.26
280	1113.42	1431.98	1777.22	1207.28	1561.22	1944.78	1301.12	1690.42	2112.29
300	1138.16	1479.42	1849.30	1234.65	1613.88	2024.79	1331.22	1748.33	2200.45
320	1162.79	1526.84	1921.34	1262.08	1666.60	2104.89	1361.41	1806.25	2288.55
340	1187.40	1574.24	1993.37	1289.44	1719.25	2184.95	1391.52	1864.24	2376.59
360	1212.08	1621.69	2065.46	1316.90	1771.92	2265.06	1421.68	1922.18	2464.64
380	1236.79	1669.04	2137.53	1344.34	1824.58	2345.12	1451.79	1980.10	2552.70
400	1261.34	1716.44	2209.62	1371.67	1877.28	2425.19	1481.89	2038.07	2640.83

Width cm	UP TO 240			UP TO 260			UP TO 280		
	1	2	3	1	2	3	1	2	3
Drop cm									
60	1033.32	1124.33	1222.97	1096.96	1195.53	1302.37	1160.65	1266.85	1381.89
80	1066.14	1187.45	1319.07	1132.58	1264.01	1406.48	1198.97	1340.53	1493.96
100	1099.06	1250.70	1415.06	1168.18	1332.49	1510.62	1237.36	1414.31	1606.09
120	1131.94	1313.95	1511.13	1203.79	1400.96	1614.71	1275.75	1488.10	1718.24
140	1164.71	1377.13	1607.28	1239.43	1469.52	1718.81	1314.09	1561.82	1830.33
160	1197.67	1440.31	1703.39	1275.01	1538.00	1822.92	1352.40	1635.57	1942.36
180	1230.53	1503.59	1799.45	1310.68	1606.43	1926.95	1390.75	1709.33	2054.55
200	1263.40	1566.77	1895.61	1346.27	1674.86	2031.08	1429.14	1783.08	2166.61
220	1296.32	1629.95	1991.58	1381.89	1743.41	2135.24	1467.55	1856.77	2278.74
240	1329.10	1693.14	2087.67	1417.49	1811.89	2239.24	1505.88	1930.54	2390.82
260	1362.02	1756.45	2183.81	1453.12	1880.39	2343.43	1544.21	2004.33	2502.94
280	1394.93	1819.62	2279.85	1488.73	1948.84	2447.46	1582.55	2077.98	2615.06
300	1427.77	1882.92	2376.00	1524.34	2017.31	2551.53	1620.89	2151.80	2727.10
320	1460.70	1946.06	2472.08	1559.96	2085.76	2655.64	1659.31	2225.56	2839.28
340	1493.51	2009.28	2568.15	1595.61	2154.32	2759.72	1697.68	2299.33	2951.29
360	1526.42	2072.48	2664.21	1631.22	2222.78	2863.83	1735.98	2373.04	3063.45
380	1559.29	2135.75	2760.26	1666.78	2291.28	2967.91	1774.34	2446.75	3175.52
400	1592.13	2198.92	2856.41	1702.44	2359.71	3071.96	1812.65	2520.50	3287.62

All prices shown exclude VAT



# SG 2900 complete with fabric

The prices below comprise complete system, silver or white ready-to-hang, top fix, single or pair stack with fabric choice in 127mm/5" louvres (see fabric price categories). Includes bottom weights and bottom link cord to both sides, 150cm drop operating crank handle. Wall fix brackets extra. For 89mm/3½" louvres add 15%. If sizes lie between the measurements shown, the price for the next larger size will apply. Set up costs apply for 3D vertical waves.

Price Category C

Width cm	UP TO 300			UP TO 320			UP TO 340		
	1	2	3	1	2	3	1	2	3
Drop cm									
60	1224.35	1338.08	1461.34	1288.00	1409.33	1540.90	1351.72	1480.61	1620.37
80	1265.39	1417.17	1581.49	1331.85	1493.61	1668.96	1398.27	1570.13	1756.52
100	1306.50	1496.15	1701.60	1375.66	1577.94	1797.13	1444.86	1659.74	1892.60
120	1347.59	1575.14	1821.66	1419.54	1662.16	1925.22	1491.42	1749.24	2028.73
140	1388.65	1654.20	1941.89	1463.37	1746.47	2053.37	1538.00	1838.90	2164.81
160	1429.79	1733.19	2061.93	1507.18	1830.74	2181.40	1584.56	1928.38	2300.93
180	1470.89	1812.18	2182.04	1551.05	1915.08	2309.55	1631.13	2017.96	2437.10
200	1511.98	1891.20	2302.12	1594.92	1999.31	2437.68	1677.73	2107.52	2573.21
220	1553.09	1970.19	2422.23	1638.72	2083.63	2565.81	1724.32	2197.03	2709.35
240	1594.19	2049.17	2542.41	1682.53	2167.91	2693.94	1770.88	2286.57	2845.48
260	1635.27	2128.22	2662.47	1726.31	2252.18	2822.04	1817.42	2376.14	2981.60
280	1676.41	2207.29	2782.63	1770.19	2336.48	2950.17	1864.03	2465.64	3117.77
300	1717.46	2286.29	2902.72	1814.04	2420.77	3078.30	1910.62	2555.29	3253.82
320	1758.59	2365.28	3022.78	1857.89	2505.07	3206.33	1957.18	2644.77	3389.99
340	1799.65	2444.31	3142.91	1901.72	2589.32	3334.48	2003.68	2734.31	3526.07
360	1840.79	2523.31	3263.03	1945.47	2673.64	3462.61	2050.30	2823.92	3662.22
380	1881.80	2602.34	3383.13	1989.38	2757.90	3590.78	2096.87	2913.43	3798.32
400	1923.00	2681.33	3503.21	2033.22	2842.25	3718.90	2143.46	3003.00	3934.46

Width cm	UP TO 360			UP TO 380			UP TO 400		
	1	2	3	1	2	3	1	2	3
Drop cm									
60	1415.36	1551.86	1699.80	1479.09	1623.17	1779.34	1542.71	1694.42	1858.83
80	1464.69	1646.74	1843.95	1531.13	1723.23	1931.41	1597.53	1799.79	2018.95
100	1514.00	1741.57	1988.05	1583.18	1823.34	2083.60	1652.27	1905.16	2179.11
120	1563.29	1836.35	2132.28	1635.23	1923.40	2235.75	1707.08	2010.48	2339.24
140	1612.67	1931.20	2276.40	1687.33	2023.50	2387.84	1761.94	2115.78	2499.38
160	1661.93	2026.02	2420.49	1739.30	2123.56	2539.96	1816.74	2221.23	2659.55
180	1711.24	2120.78	2564.62	1791.36	2223.69	2692.15	1871.49	2326.51	2819.69
200	1760.52	2215.62	2708.72	1843.43	2323.75	2844.26	1926.33	2431.88	2979.84
220	1809.92	2310.40	2852.86	1895.52	2423.87	2996.47	1981.08	2537.28	3139.99
240	1859.18	2405.31	2997.07	1947.54	2523.92	3148.52	2035.89	2642.60	3300.10
260	1908.51	2500.06	3141.18	1999.65	2624.01	3300.73	2090.68	2747.96	3460.29
280	1957.82	2594.87	3285.26	2051.64	2724.09	3452.90	2145.47	2853.28	3620.41
300	2007.14	2689.70	3429.43	2103.73	2824.17	3604.97	2200.28	2958.65	3780.49
320	2056.46	2784.55	3573.60	2155.75	2924.25	3757.21	2255.06	3064.05	3940.72
340	2105.77	2879.40	3717.68	2207.83	3024.36	3909.25	2309.85	3169.37	4100.82
360	2155.06	2974.15	3861.85	2259.87	3124.48	4061.38	2364.64	3274.68	4261.03
380	2204.40	3069.00	4005.90	2311.88	3224.49	4213.51	2419.40	3380.04	4421.20
400	2253.72	3163.81	4150.09	2363.98	3324.65	4365.70	2474.19	3485.40	4581.36

Width cm	UP TO 420			UP TO 440			UP TO 460		
	1	2	3	1	2	3	1	2	3
Drop cm									
60	1606.42	1765.67	1938.30	1670.16	1836.97	2017.73	1733.80	1908.16	2097.23
80	1663.93	1876.31	2106.47	1730.39	1952.82	2193.96	1796.85	2029.44	2281.38
100	1721.47	1986.90	2274.62	1790.68	2068.71	2370.14	1859.75	2150.59	2465.60
120	1779.04	2097.58	2442.78	1850.97	2184.57	2546.26	1922.79	2271.72	2649.80
140	1836.57	2208.18	2610.93	1911.22	2300.49	2722.49	1985.87	2392.85	2833.91
160	1894.10	2318.75	2779.06	1971.47	2416.40	2898.60	2048.88	2513.99	3018.14
180	1951.62	2429.43	2947.18	2031.71	2532.29	3074.81	2111.88	2635.18	3202.28
200	2009.14	2539.97	3115.34	2092.04	2648.19	3250.91	2174.89	2756.31	3386.44
220	2066.73	2650.71	3283.53	2152.35	2764.06	3427.11	2237.88	2877.52	3570.63
240	2124.24	2761.27	3451.69	2212.54	2879.96	3603.24	2300.91	2998.58	3754.78
260	2181.79	2871.94	3619.76	2272.88	2995.85	3779.40	2363.93	3119.80	3938.95
280	2239.27	2982.56	3787.96	2333.07	3111.70	3955.57	2426.92	3240.97	4123.10
300	2296.82	3093.19	3956.15	2393.38	3227.60	4131.75	2489.98	3362.14	4307.25
320	2354.35	3203.76	4124.27	2453.68	3343.48	4307.88	2552.95	3483.31	4491.50
340	2411.86	3314.38	4292.47	2513.89	3459.35	4484.00	2615.97	3604.43	4675.65
360	2469.35	3424.95	4460.59	2574.18	3575.29	4660.21	2678.95	3725.55	4859.81
380	2526.98	3535.61	4628.81	2634.48	3691.18	4836.39	2741.94	3846.77	5043.97
400	2584.49	3646.27	4796.95	2694.74	3807.11	5012.54	2805.01	3967.85	5228.19

All prices shown exclude VAT



# SG 2900 complete with fabric

The prices below comprise complete system, silver or white ready-to-hang, top fix, single or pair stack with fabric choice in 127mm/5" louvres (see fabric price categories). Includes bottom weights and bottom link cord to both sides, 150cm drop operating crank handle. Wall fix brackets extra. For 89mm/3½" louvres add 15%. If sizes lie between the measurements shown, the price for the next larger size will apply. Set up costs apply for 3D vertical waves.

Price Category C

Width cm	UP TO 480			UP TO 500			UP TO 520		
	1	2	3	1	2	3	1	2	3
Drop cm									
60	1797.50	1979.57	2176.82	1861.10	2050.76	2256.28	1924.79	2122.00	2335.65
80	1863.28	2105.91	2368.96	1929.61	2182.37	2456.40	1996.12	2259.00	2543.91
100	1929.00	2232.38	2561.04	1998.07	2314.15	2656.59	2067.28	2395.94	2752.10
120	1994.72	2358.79	2753.29	2066.64	2445.81	2856.80	2138.53	2532.87	2960.35
140	2060.46	2485.19	2945.43	2135.13	2577.53	3057.00	2209.76	2669.91	3168.54
160	2126.26	2611.64	3137.62	2203.58	2709.25	3257.12	2281.00	2806.81	3376.72
180	2191.95	2738.03	3329.83	2272.10	2840.94	3457.32	2352.23	2943.82	3584.87
200	2257.73	2864.38	3521.96	2340.56	2972.63	3657.49	2423.43	3080.74	3793.09
220	2323.49	2990.88	3714.18	2409.13	3104.30	3857.69	2494.70	3217.70	4001.23
240	2389.24	3117.31	3906.34	2477.62	3236.04	4057.87	2565.92	3354.68	4209.42
260	2455.04	3243.72	4098.56	2546.08	3367.63	4258.05	2637.14	3491.64	4417.61
280	2520.71	3370.17	4290.69	2614.55	3499.37	4458.22	2708.42	3628.63	4625.78
300	2586.52	3496.59	4482.83	2683.06	3631.08	4658.41	2779.64	3765.56	4833.97
320	2652.29	3623.01	4675.08	2751.57	3762.72	4858.71	2850.85	3902.49	5042.25
340	2718.01	3749.43	4867.19	2820.06	3894.43	5058.79	2922.10	4039.48	5250.36
360	2783.77	3875.90	5059.44	2888.54	4026.18	5258.99	2993.33	4176.46	5458.54
380	2849.52	4002.25	5251.62	2956.99	4157.81	5459.15	3064.58	4313.38	5666.73
400	2915.23	4128.67	5443.77	3025.46	4289.58	5659.41	3135.78	4450.37	5874.98

Width cm	UP TO 540			UP TO 560			UP TO 580		
	1	2	3	1	2	3	1	2	3
Drop cm									
60	1988.52	2193.30	2415.23	2052.16	2264.54	2494.70	2115.90	2335.83	2574.13
80	2062.48	2335.54	2631.44	2128.90	2412.10	2718.89	2195.28	2488.59	2806.43
100	2136.48	2477.77	2847.62	2205.63	2559.57	2943.07	2274.81	2641.30	3038.55
120	2210.49	2619.93	3063.79	2282.29	2706.98	3167.30	2354.24	2794.15	3270.83
140	2284.36	2762.18	3279.97	2359.06	2854.54	3391.53	2433.69	2946.85	3503.00
160	2358.36	2904.44	3496.22	2435.79	3002.05	3615.71	2513.15	3099.62	3735.22
180	2432.32	3046.64	3712.44	2512.47	3149.55	3839.91	2592.51	3252.43	3967.48
200	2506.36	3188.91	3928.62	2589.17	3297.00	4064.08	2672.02	3405.16	4199.59
220	2580.27	3331.15	4144.73	2665.92	3444.51	4288.42	2751.51	3557.97	4431.89
240	2654.25	3473.36	4360.99	2742.59	3592.03	4512.53	2830.97	3710.71	4664.04
260	2728.24	3615.58	4577.17	2819.31	3739.50	4736.74	2910.40	3863.50	4896.34
280	2802.22	3757.79	4793.40	2896.06	3887.06	4960.93	2989.81	4016.22	5128.57
300	2876.15	3900.04	5009.62	2972.72	4034.40	5185.22	3069.25	4169.03	5360.74
320	2950.17	4042.24	5225.76	3049.50	4182.03	5409.34	3148.76	4321.70	5593.02
340	3024.09	4184.48	5442.02	3126.14	4329.48	5633.59	3228.23	4474.51	5825.18
360	3098.12	4326.72	5658.15	3202.87	4476.98	5857.76	3307.66	4627.29	6057.38
380	3172.00	4468.92	5874.39	3279.55	4624.46	6082.03	3387.10	4780.02	6289.60
400	3245.98	4611.21	6090.60	3356.26	4771.96	6306.16	3466.48	4932.78	6521.85

Width cm	UP TO 600		
	1	2	3
Drop cm			
60	2179.54	2407.10	2653.61
80	2261.73	2565.13	2893.86
100	2343.95	2723.20	3134.16
120	2426.09	2881.16	3374.36
140	2508.31	3039.24	3614.58
160	2590.57	3197.28	3854.78
180	2672.79	3355.31	4094.94
200	2754.97	3513.33	4335.21
220	2837.11	3671.32	4575.45
240	2919.31	3829.36	4815.64
260	3001.52	3987.41	5055.84
280	3083.71	4145.43	5296.14
300	3165.85	4303.49	5536.31
320	3248.07	4461.49	5776.49
340	3330.25	4619.53	6016.80
360	3412.40	4777.59	6256.98
380	3494.56	4935.61	6497.18
400	3576.75	5093.66	6737.37

All prices shown exclude VAT



# Roller Blind Systems

## SG 4900

Spring operation with decelerator.  
Tube diameter 32.2mm

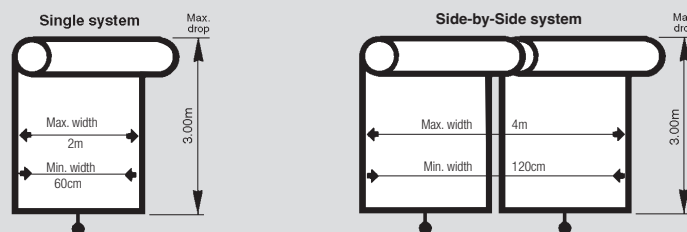

### System 4900 complete with fabric

The prices below comprise the complete system made-to-measure, ready-to-hang with fabric of your choice. Operation as standard with pull-ball.  
Please consult application chart (page 57 of our main price list) to ensure that fabric chosen can be supplied in dimensions required.

Price category C

#### Price Group 1R

- Basicscreen 5%
- Basicscreen 10%
- Colorama 1
- Colorama 1 Alu
- Colorama 1 Bioactive
- Colorama 1 Eco
- Colorama 1 Multicolour
- Colorama Acoustic
- Colorama Acoustic Multicolour
- Element
- Puma

Width	60cm	80cm	100cm	120cm	140cm	160cm	180cm	200cm	Width
Drop cm									Drop cm
60	317.19	335.41	353.64	371.93	390.10	408.45	426.61	444.86	60
80	323.50	343.80	364.17	384.42	404.79	425.12	445.49	465.74	80
100	329.74	352.18	374.59	397.07	419.40	441.84	464.29	486.74	100
120	336.03	360.51	385.03	409.61	434.01	458.64	483.11	507.65	120
140	342.28	368.87	395.48	422.14	448.68	475.30	501.90	528.55	140
160	348.53	377.25	405.94	434.70	463.36	492.02	520.77	549.47	160
180	354.79	385.64	416.46	447.23	478.01	508.82	539.66	570.30	180
200	361.22	393.94	426.87	459.79	492.58	525.55	558.39	591.32	200
220	367.41	402.41	437.39	472.24	507.24	542.25	577.25	612.19	220
240	373.69	410.76	447.79	484.89	521.92	559.01	596.06	633.11	240
260	379.93	419.14	458.27	497.42	536.63	575.71	614.93	654.15	260
280	386.24	427.46	468.71	509.90	551.28	592.48	633.72	674.94	280
300	392.49	435.88	479.14	522.47	565.89	609.20	652.55	695.88	300

#### Price Group 2R

- Alutex
- Colorama 2
- Colorama 2 Bioactive
- Colorama 2 Eco
- Colorama 2 Multicolour
- Mercurio
- Multi Visio
- Multishadow
- Multiscreen 5%
- Multiscreen 10%
- Newlifescreeen
- Nox
- Triscreen 5%
- Versascreen 5%
- Versascreen 10%
- Moon
- Reflex
- Safescreeen

Width	60cm	80cm	100cm	120cm	140cm	160cm	180cm	200cm	Width
Drop cm									Drop cm
60	329.18	351.36	373.54	395.79	418.05	440.21	462.46	484.65	60
80	339.35	365.02	390.67	416.33	441.94	467.54	493.17	518.84	80
100	349.67	378.68	407.78	436.75	465.80	494.92	523.98	553.01	100
120	359.89	392.37	424.86	457.38	489.84	522.24	554.71	587.20	120
140	370.15	406.04	441.94	477.83	513.73	549.66	585.52	621.36	140
160	380.45	419.74	458.96	498.36	537.66	576.96	616.22	655.56	160
180	390.67	433.33	476.07	518.84	561.65	604.33	647.03	689.75	180
200	400.90	447.04	493.17	539.33	585.52	631.62	677.77	723.97	200
220	411.17	460.69	510.24	559.86	609.44	658.96	708.52	758.12	220
240	421.45	474.36	527.45	580.35	633.37	686.31	739.33	792.36	240
260	431.70	488.08	544.47	600.86	657.27	713.65	770.05	826.44	260
280	441.94	501.76	561.65	621.36	681.14	741.01	800.83	860.63	280
300	452.22	515.38	578.65	641.90	705.12	768.32	831.58	894.83	300

#### Price Group 3R

- Aluscreen Futura
- Deep
- Newlifescreeen Alu
- Multicolour Dimout

Width	60cm	80cm	100cm	120cm	140cm	160cm	180cm	200cm	Width
Drop cm									Drop cm
60	354.94	385.83	416.55	447.38	478.23	509.08	539.83	570.75	60
80	373.80	410.90	448.01	485.16	522.29	559.36	596.52	633.57	80
100	392.65	436.10	479.53	522.91	566.27	609.65	653.09	696.47	100
120	411.58	461.22	510.90	560.63	610.28	659.94	709.69	759.35	120
140	430.41	486.32	542.34	598.33	654.30	710.30	766.22	822.20	140
160	449.22	511.51	573.84	636.00	698.28	760.55	822.88	885.09	160
180	468.09	536.66	605.25	673.74	742.32	810.87	879.36	947.97	180
200	487.00	561.79	636.64	711.50	786.31	861.11	935.96	1010.86	200
220	505.80	586.96	668.14	749.22	830.29	911.46	992.59	1073.67	220
240	524.72	612.11	699.58	786.92	874.29	961.71	1049.15	1136.59	240
260	543.54	637.24	730.91	824.66	918.33	1012.07	1105.74	1199.38	260
280	562.41	662.39	762.40	862.39	962.31	1062.33	1162.34	1262.29	280
300	581.23	687.57	793.86	900.11	1006.37	1112.71	1218.91	1325.18	300

### Installation Profile

Provides an alternative to fitting to the wall or ceiling, supplied made to measure in silver or white £36.57 per m add on. Other custom colours available, pricing as per page 73 of our main price list.

### SG 4900 – Side-by-Side System

Simply price as two separate systems stating side-by-side.

### Stop Controller

For optional stop controller add £22.61

All prices shown exclude VAT



# Roller Blind Systems

## Laminated Blinds (Customer's own material for Roller Blinds)

Supply your own fabric, we will provide the laminating service. Prices below include for hardware systems 4900/4910. Sewn-in bottom bar supplied as standard (Trim 16). Our laminate will usually be supplied in cream as standard.

Please send a flat sample of customer's own material (1m<sup>2</sup>minimum) so that Silent Gliss can confirm suitability for laminating. All fabrics must be approved prior to ordering.

Price category C

Width cm	System	100	120	140	160	170	180	200	220	230	Width cm
Drop cm											Drop cm
90		472.90	510.14	547.51	584.71	621.95	1001.10	1016.95	1094.73	1114.02	90
120		525.72	573.50	621.49	669.30	717.04	1044.47	1082.33	1146.35	1203.49	120
150	4900/	578.59	636.91	695.57	753.83	812.15	1145.63	1206.21	1266.79	1413.39	150
180	4910/	631.42	700.30	769.54	838.38	907.26	1214.45	1357.61	1418.19	1547.60	180
210	(4960 electric)	684.21	763.73	843.49	922.97	1002.41	1362.41				210
240		736.95	826.92	917.25	1007.24	1097.22	1438.12				240
270		917.72	1019.92	1122.59	1224.79	1326.94	1592.97				270
300		970.52	1083.31	1199.17	1314.38	1432.92					300
Prices in this table are for spring or chain operation. For standard electric (4960) add £727.12.											

### Flame Retardant (FR) Laminate

Add 20% to prices shown above. FR laminate available in white or cream.

### Blackout Laminate

Add 20% to prices shown above. Blackout laminate available in white or cream.

### Decorative Trims

Price on request.

All prices shown exclude VAT





# Roller Blind Systems

## SG 4907

Chain operated roller blinds.  
Tube diameter 32.2mm

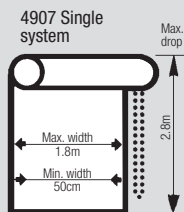

### SG 4907 complete with fabric

The prices below comprise the complete system made-to-measure, ready-to-hang with fabric of your choice. Please consult application chart (page 57) to ensure that fabric desired can be supplied in dimensions required.

Price category C

#### Price Group 1R

Basicsreen 1%  
Basicsreen 5%  
Basicsreen 10%  
Colorama 1  
Colorama 1 Alu  
Colorama 1 Bioactive  
Colorama 1 Eco  
Colorama 1 Multicolour  
Colorama Acoustic  
Colorama Acoustic Multicolour  
Element  
Puma

Width	60cm	80cm	100cm	120cm	140cm	160cm	180cm	Width
Drop cm								Drop cm
60	285.47	301.88	318.29	334.76	351.10	367.59	383.95	60
80	291.14	309.40	327.75	345.99	364.30	382.60	400.93	80
100	296.77	316.97	337.11	357.35	377.46	397.67	417.86	100
120	302.42	324.47	346.52	368.63	390.64	412.77	434.78	120
140	308.05	331.98	355.95	379.92	403.81	427.79	451.72	140
160	313.68	339.52	365.34	391.24	417.03	442.84	468.69	160
180	319.34	347.07	374.82	402.48	430.23	457.95	485.68	180
200	325.07	354.55	384.20	413.80	443.33	472.98	502.58	200
220	330.65	362.17	393.62	425.04	456.53	488.02	519.52	220
240	336.32	369.72	403.02	436.43	469.71	503.12	536.47	240
260	341.93	377.23	412.43	447.70	482.97	518.14	553.42	260
280	347.61	384.72	421.83	458.90	496.15	533.19	570.32	280

#### Price Group 2R

Alutex  
Colorama 2  
Colorama 2 Bioactive  
Colorama 2 Eco  
Colorama 2 Multicolour  
Mercurio  
Multi Visio  
Multishadow  
Multiscreen 1%  
Multiscreen 5%  
Multiscreen 10%  
Newlifescreeen  
Nox

Triscreen 5%  
Versascreen 5%  
Versascreen 10%  
Moon  
Reflex  
Safescreen

Width	60cm	80cm	100cm	120cm	140cm	160cm	180cm	Width
Drop cm								Drop cm
60	296.25	316.24	336.20	356.22	376.24	396.18	416.19	60
80	305.42	328.53	351.61	374.70	397.76	420.77	443.87	80
100	314.68	340.82	366.98	393.09	419.21	445.40	471.58	100
120	323.89	353.16	382.38	411.64	440.85	470.03	499.24	120
140	333.13	365.44	397.76	430.03	462.36	494.67	526.96	140
160	342.39	377.75	413.09	448.49	483.90	519.25	554.58	160
180	351.61	389.98	428.46	466.96	505.47	543.90	582.34	180
200	360.80	402.30	443.87	485.41	526.96	568.46	609.98	200
220	370.04	414.64	459.23	503.85	548.48	593.08	637.67	220
240	379.32	426.91	474.70	522.29	570.00	617.69	665.41	240
260	388.55	439.27	490.03	540.80	591.53	642.29	693.05	260
280	397.76	451.57	505.47	559.22	613.03	666.91	720.72	280

#### Price Group 3R

Aluscreen Futura  
Deep  
Newlifescreeen Alu  
Multicolour Dimout

Width	60cm	80cm	100cm	120cm	140cm	160cm	180cm	Width
Drop cm								Drop cm
60	319.43	347.23	374.89	402.66	430.36	458.17	485.86	60
80	336.43	369.81	403.20	436.66	470.09	503.42	536.88	80
100	353.37	392.49	431.59	470.63	509.63	548.70	587.78	100
120	370.42	415.08	459.81	504.56	549.26	593.96	638.74	120
140	387.38	437.69	488.12	538.50	588.88	639.29	689.61	140
160	404.30	460.36	516.46	572.43	628.45	684.49	740.59	160
180	421.28	483.00	544.73	606.38	668.10	729.76	791.43	180
200	438.29	505.61	572.99	640.34	707.68	775.00	842.35	200
220	455.22	528.29	601.33	674.32	747.27	820.31	893.32	220
240	472.24	550.90	629.59	708.22	786.84	865.55	944.22	240
260	489.18	573.49	657.84	742.21	826.49	910.87	995.12	260
280	506.16	596.16	686.13	776.15	866.08	956.12	1046.10	280

### SG 4907 – Side-by-Side System

There is no add-on. Simply order two systems, stating side-by-side.

### Installation Profile

Provides an alternative to fitting to the wall or ceiling, supplied made to measure in silver or white £36.57 per m add on. Other custom colours available, pricing as per page 73 of our main price list.

All prices shown exclude VAT

# Roller Blind Systems

## SG 4910

Chain operated roller blinds.  
Tube diameter 41mm

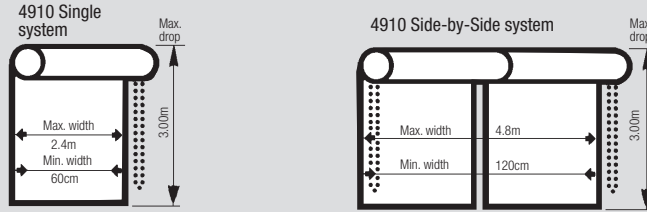

### SG 4910 complete with fabric

The prices below comprise the complete system made-to-measure, ready-to-hang with fabric of your choice. Brackets, bracket covers, bottom bar and bottom bar endcaps supplied as standard in either white, grey or black. Please consult application chart (page 57) to ensure that fabric desired can be supplied in dimensions required. Stainless steel operating chain supplied as standard (brass chain also available at no additional cost).

Price category C

#### Price Group 1R

Basicscreen 1%  
Basicscreen 5%  
Basicscreen 10%  
Colorama 1  
Colorama 1 Alu  
Colorama 1 Bioactive  
Colorama 1 Eco  
Colorama 1 Multicolour  
Colorama Acoustic  
Colorama Acoustic Multicolour  
Element  
Puma

Width	60cm	80cm	100cm	120cm	140cm	160cm	180cm	200cm	220cm	230cm	240cm	Width
Drop cm												Drop cm
60	317.19	335.41	353.64	371.93	390.10	408.45	426.61	444.86	463.10	472.20	481.37	60
80	323.50	343.80	364.17	384.42	404.79	425.12	445.49	465.74	486.09	496.28	506.46	80
100	329.74	352.18	374.59	397.07	419.40	441.84	464.29	486.74	506.56	516.49	526.40	100
120	336.03	360.51	385.03	409.61	434.01	458.64	483.11	507.65	532.14	544.41	556.64	120
140	342.28	368.87	395.48	422.14	448.68	475.30	501.90	528.55	555.14	568.48	581.71	140
160	348.53	377.25	405.94	434.70	463.36	492.02	520.77	549.47	578.23	592.63	606.98	160
180	354.79	385.64	416.46	447.23	478.01	508.82	539.66	570.30	601.09	616.53	631.85	180
200	361.22	393.94	426.87	459.79	492.58	525.55	558.39	591.32	624.18	640.58	656.98	200
220	367.41	402.41	437.39	472.24	507.24	542.25	577.25	612.19	647.24	664.69	682.22	220
240	373.69	410.76	447.79	484.89	521.92	559.01	596.06	633.11	670.14	688.71	707.18	240
260	379.93	419.14	458.27	497.42	536.63	575.71	614.93	654.15	693.24	712.79	732.35	260
280	386.24	427.46	468.71	509.90	551.28	592.48	633.72	674.94	716.17	736.75	757.37	280
300	392.49	435.88	479.14	522.47	565.89	609.20	652.55	695.88	739.21	760.87	782.58	300

#### Price Group 2R

Alutex  
Atracor  
Colorama 2  
Colorama 2 Bioactive  
Colorama 2 Eco  
Colorama 2 Multicolour  
Mercurio  
Multi Visio  
Multishadow  
Multiscreen 1%  
Multiscreen 5%  
Multiscreen 10%  
Newlifescreeen  
Nox

Triscreen 1%  
Triscreen 3%  
Triscreen 5%  
Versascreen 1%  
Versascreen 2%  
Versascreen 10%  
Moon  
Reflex  
Safescreen

Width	60cm	80cm	100cm	120cm	140cm	160cm	180cm	200cm	220cm	230cm	240cm	Width
Drop cm												Drop cm
60	329.18	351.36	373.54	395.79	418.05	440.21	462.46	484.65	506.81	517.93	529.05	60
80	339.35	365.02	390.67	416.33	441.94	467.54	493.17	518.84	544.47	557.33	570.14	80
100	349.67	378.68	407.78	436.75	465.80	494.92	523.98	553.01	582.01	596.56	611.06	100
120	359.89	392.37	424.86	457.38	489.84	522.24	554.71	587.20	619.74	635.97	652.25	120
140	370.15	406.04	441.94	477.83	513.73	549.66	585.52	621.36	657.27	675.25	693.16	140
160	380.45	419.74	458.96	498.36	537.66	576.96	616.22	655.56	694.86	714.46	734.13	160
180	390.67	433.33	476.07	518.84	561.65	604.33	647.03	689.75	732.48	753.87	775.25	180
200	400.90	447.04	493.17	539.33	585.52	631.62	677.77	723.97	770.06	793.15	816.19	200
220	411.17	460.69	510.24	559.86	609.44	658.96	708.52	758.12	807.68	832.49	857.20	220
240	421.45	474.36	527.45	580.35	633.37	686.31	739.33	792.36	845.29	871.81	898.24	240
260	431.70	488.08	544.47	600.86	657.27	713.65	770.05	826.44	882.85	911.06	939.34	260
280	441.94	501.76	561.65	621.36	681.14	741.01	800.83	860.63	920.43	950.31	980.19	280
300	452.22	515.38	578.65	641.90	705.12	768.32	831.58	894.83	958.05	989.70	1021.28	300

#### Price Group 3R

Aluscreen Futura  
Deep  
Jumbotex  
Newlifescreeen Alu  
Multicolour Dimout

Width	60cm	80cm	100cm	120cm	140cm	160cm	180cm	200cm	220cm	230cm	240cm	Width
Drop cm												Drop cm
60	354.94	385.83	416.55	447.38	478.23	509.08	539.83	570.75	601.48	616.92	632.38	60
80	373.80	410.90	448.01	485.16	522.29	559.36	596.52	633.57	670.69	689.26	707.83	80
100	392.65	436.10	479.53	522.91	566.27	609.65	653.09	696.47	739.90	761.84	783.86	100
120	411.58	461.22	510.90	560.63	610.28	659.94	709.69	759.35	809.01	833.89	858.76	120
140	430.41	486.32	542.34	598.33	654.30	710.30	766.22	822.20	878.18	906.18	934.19	140
160	449.22	511.51	573.84	636.00	698.28	760.55	822.88	885.09	947.31	978.47	1009.61	160
180	468.09	536.66	605.25	673.74	742.32	810.87	879.36	947.97	1016.47	1050.67	1084.90	180
200	487.00	561.79	636.64	711.50	786.31	861.11	935.96	1010.86	1085.68	1123.12	1160.53	200
220	505.80	586.96	668.14	749.22	830.29	911.46	992.59	1073.67	1154.84	1195.41	1235.98	220
240	524.72	612.11	699.58	786.92	874.29	961.71	1049.15	1136.59	1224.03	1267.72	1311.43	240
260	543.54	637.24	730.91	824.66	918.33	1012.07	1105.74	1199.38	1293.10	1339.97	1386.79	260
280	562.41	662.39	762.40	862.39	962.31	1062.33	1162.34	1262.29	1362.22	1412.19	1462.21	280
300	581.23	687.57	793.86	900.11	1006.37	1112.71	1218.91	1325.18	1431.40	1484.51	1537.61	300

Child safety device (10482) – add-on £12.49.

### Side-guiding

Side-guide wire option is available (with white, grey or black accessories) at an additional cost of £85.22.

### SG 4910 – Side-by-Side System

There is no add-on. Simply order two systems, stating side-by-side. Intermediate Cover 10632 required.

### Installation Profile

Provides an alternative to fitting to the wall or ceiling, supplied made to measure in silver, black or white £36.57 per m add on. Other custom colours available, pricing as per page 73.

### Adjustable End Stop

For the setting of upper or lower end position - add on £39.68.

All prices shown exclude VAT



# Roller Blind Systems

## SG 4930

Heavy duty chain operated  
Roller Blind system.  
Tube diameter 60mm.

\*Max. surface area 17m<sup>2</sup>  
\*Max. m<sup>2</sup> depends on fabric type.

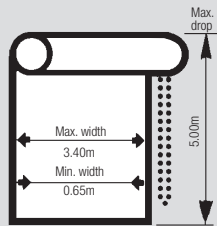

### SG 4930 complete with fabric

The prices below comprise the complete system made-to-measure, ready to hang with fabric of your choice. Brackets, bracket covers, bottom bar and bottom bar endcaps supplied as standard in either white, grey or black. Please be aware that due to the size capabilities of this system, larger sizes can only be achieved by welding the fabric. Fabrics that can be welded are indicated below in bold print. Please consult application chart (page 57) to ensure that fabric desired can be supplied in dimensions required.

Price Category C

#### Price Group 1R

**Basicscreen 1%**  
**Basicscreen 5%**  
**Basicscreen 10%**  
Colorama 1  
Colorama 1 Alu  
Colorama 1 Bioactive  
Colorama 1 Eco  
Colorama 1 Multicolour  
Colorama Acoustic  
Colorama Acoustic Multicolour  
Element  
**Puma**

Width Drop	100cm	125cm	150cm	175cm	200cm	225cm	250cm	275cm	300cm	325cm	340cm	Width Drop
50cm	434.12	473.13	511.84	551.87	589.49	640.37	668.36	705.98	744.87	783.68	806.97	50cm
100cm	459.81	505.68	551.02	596.43	641.77	687.21	732.55	777.85	823.27	868.67	895.88	100cm
150cm	486.47	538.38	590.24	642.12	694.08	745.98	797.89	849.79	901.67	953.60	971.68	150cm
200cm	512.60	571.01	629.44	687.88	746.32	804.74	863.23	921.66	980.13	1038.56	1073.61	200cm
250cm	538.72	603.69	668.70	733.66	798.65	863.60	928.59	993.57	1058.54	1123.53	1162.52	250cm
300cm	564.88	636.38	707.93	779.42	850.86	922.43	993.92	1065.45	1137.00	1208.48	1251.38	300cm
350cm	591.03	669.06	747.13	825.18	903.20	981.26	1059.33	1137.31	1215.41	1293.44	1340.24	350cm
400cm	617.19	701.77	786.31	870.90	955.48	1040.07	1124.71	1209.27	1293.94	1378.38	1429.11	400cm
450cm	643.31	734.47	825.50	916.62	1007.75	1098.90	1190.09	1281.21	1372.23	1463.35	1517.99	450cm
500cm	669.46	767.16	864.70	962.34	1060.03	1157.71	1255.49	1353.14	1450.64	1548.30	1606.89	500cm

#### Price Group 2R

Alutex  
Atracor  
Colorama 2  
Colorama 2 Bioactive  
Colorama 2 Eco  
Colorama 2 Multicolour  
Mercurio  
Multi Visio  
Multishadow  
**Multiscreen 1%**  
**Multiscreen 5%**  
**Multiscreen 10%**  
Newlifescreeen  
Nox

**Triscreen 1%**  
**Triscreen 3%**  
**Triscreen 5%**  
**Versascreen 1%**  
**Versascreen 2%**  
**Versascreen 5%**  
**Versascreen 10%**  
Moon  
Reflex  
Safescreen

Width Drop	100cm	125cm	150cm	175cm	200cm	225cm	250cm	275cm	300cm	325cm	340cm	Width Drop
50cm	467.41	514.49	561.70	608.89	662.24	703.12	750.26	797.38	844.51	891.68	920.01	50cm
100cm	510.15	567.98	625.80	683.61	741.48	799.32	857.14	914.98	972.84	1030.64	1065.31	100cm
150cm	552.91	621.42	689.94	758.42	826.98	895.47	964.05	1032.54	1101.10	1169.64	1210.74	150cm
200cm	595.66	674.88	754.06	833.26	912.52	991.69	1070.93	1150.15	1229.36	1308.53	1356.08	200cm
250cm	638.40	728.31	818.24	908.13	998.01	1087.92	1177.81	1267.71	1357.63	1451.51	1507.82	250cm
300cm	681.14	781.78	882.37	982.97	1083.59	1184.11	1284.75	1385.37	1485.87	1586.50	1646.90	300cm
350cm	723.97	835.21	946.46	1057.77	1169.07	1280.34	1391.62	1502.89	1614.22	1721.52	1785.90	350cm
400cm	766.68	888.68	1010.66	1132.59	1254.58	1376.54	1498.50	1620.49	1742.55	1856.53	1924.92	400cm
450cm	809.39	942.16	1074.84	1207.40	1340.11	1472.72	1605.36	1738.10	1870.91	1991.56	2063.92	450cm
500cm	852.12	995.62	1139.00	1282.22	1425.62	1568.94	1712.23	1855.53	1999.24	2126.57	2202.94	500cm

#### Price Group 3R

**Aluscreen Futura**  
Deep  
Jumbotex  
Newlifescreeen Alu  
Multicolour Dimout

Width Drop	100cm	125cm	150cm	175cm	200cm	225cm	250cm	275cm	300cm	325cm	340cm	Width Drop
50cm	539.12	604.20	669.27	734.37	799.44	864.55	929.62	994.73	1059.79			50cm
100cm	617.74	702.50	787.24	871.98	956.73	1041.43	1126.18	1210.91	1295.66			100cm
150cm	696.38	800.80	905.17	1009.58	1113.99	1218.41	1322.79	1427.14	1531.54			150cm
200cm	775.03	899.06	1023.08	1147.16	1271.22	1395.29	1519.35	1643.41	1767.47			200cm
250cm	853.65	997.38	1141.08	1284.78	1428.50	1572.21	1715.89	1859.59	2003.32			250cm
300cm	932.23	1095.63	1259.02	1422.41	1585.78	1749.14	1912.49	2075.86	2239.22			300cm
350cm	1010.93	1193.95	1376.97	1559.99	1743.02	1926.02	2109.11	2292.11	2475.12			350cm
400cm	1089.54	1292.25	1494.91	1697.59	1900.28	2102.95	2305.66	2508.58	2711.02			400cm
450cm	1168.12	1390.54	1612.88	1835.20	2057.54	2279.88	2502.21	2725.02	2946.94			450cm
500cm	1246.73	1488.81	1731.74	1972.83	2214.80	2456.83	2698.75	2941.45	3182.84			500cm

Side-Guiding: Side-guide wires with accessories: Please add £72.42 per system.

#### Installation Profile

Provides an alternative to fitting to the wall or ceiling, supplied made to measure in grey, black or white £36.57 per m add on. Other custom colours available, pricing as per page 73.

Prices shown exclude VAT

# Roller Blind Systems



## SG 4930 – Double Connected System

Heavy duty chain operated Roller Blind system.  
Tube diameter 60mm.

\*Max. surface area 30m<sup>2</sup> (15m<sup>2</sup> for each panel of side by side system)

\*Max. m<sup>2</sup> depends on fabric type.

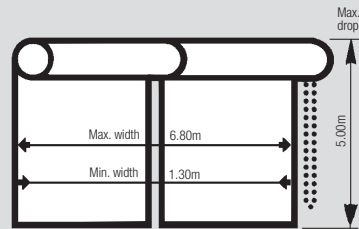

### SG 4930 – Double Connected System complete with fabric

The prices below comprise the complete system made-to-measure, ready to hang with fabric of your choice. Brackets, bracket covers, bottom bar and bottom bar endcaps supplied as standard in either white, grey or black. Please be aware that due to the size capabilities of this system, larger sizes can only be achieved by welding the fabric. Fabrics that can be welded are indicated below in bold print. If a system is required as a double system smaller than widths indicated below, please add £121.26 to single system price. Please consult application chart (page 57) to ensure that fabric desired can be supplied in dimensions required.

Price Category C

#### Price Group 1R

**Basicscreen 1%**  
**Basicscreen 5%**  
**Basicscreen 10%**  
Colorama 1  
Colorama 1 Alu  
Colorama 1 Bioactive  
Colorama 1 Eco  
Colorama 1 Multicolour  
Colorama Acoustic  
Colorama Acoustic Multicolour  
Element  
**Puma**

Width Drop	350cm	375cm	400cm	425cm	450cm	475cm	500cm	525cm	550cm	575cm	600cm	625cm	650cm	680cm	Width Drop
50cm	991.65	1030.52	1069.32	1108.15	1147.04	1185.87	1224.65	1263.50	1302.36	1341.15	1380.00	1418.85	1457.71	1504.34	50cm
100cm	1083.15	1128.53	1173.90	1219.25	1264.68	1310.06	1355.39	1400.80	1446.12	1491.53	1536.90	1582.26	1627.62	1682.06	100cm
150cm	1174.64	1226.53	1278.47	1330.41	1382.33	1434.22	1486.09	1538.02	1589.92	1641.85	1693.69	1745.72	1797.50	1859.68	150cm
200cm	1266.18	1324.59	1383.00	1441.49	1499.93	1558.35	1616.82	1675.25	1733.70	1792.14	1850.59	1909.02	1967.43	2037.47	200cm
250cm	1357.63	1422.63	1487.61	1552.54	1617.54	1682.54	1747.57	1812.53	1877.49	1942.42	2007.48	2072.35	2137.33	2215.29	250cm
300cm	1449.16	1520.68	1592.23	1663.61	1735.18	1806.73	1878.31	1949.78	2021.28	2092.71	2164.36	2235.67	2307.22	2393.10	300cm
350cm	1540.69	1618.73	1696.82	1774.72	1852.79	1930.90	2009.06	2087.02	2165.07	2242.99	2321.23	2398.97	2477.13	2570.92	350cm
400cm	1632.22	1716.80	1801.43	1885.83	1970.44	2055.10	2139.80	2224.30	2308.86	2393.28	2478.14	2562.29	2647.03	2748.69	400cm
450cm	1723.77	1814.86	1906.04	1996.79	2088.05	2179.27	2270.56	2361.53	2452.67	2543.56	2635.02	2725.62	2816.92	450cm	
500cm	1815.29	1912.91	2010.63	2107.88	2205.66	2303.45	2401.30	2498.79	2596.43	2693.85	2791.90			500cm	

#### Price Group 2R

Alutex  
Atracor  
Colorama 2  
Colorama 2 Bioactive  
Colorama 2 Eco  
Colorama 2 Multicolour  
Mercurio  
Multi Visio  
Multishadow  
**Multiscreen 1%**  
**Multiscreen 5%**  
**Multiscreen 10%**  
Newlifescreeen  
Nox

**Triscreen 1%**  
**Triscreen 3%**  
**Triscreen 5%**  
**Versascreen 1%**  
**Versascreen 2%**  
**Versascreen 5%**  
**Versascreen 10%**  
Moon  
Reflex  
Safescreen

Width Drop	350cm	375cm	400cm	425cm	450cm	475cm	500cm	525cm	550cm	575cm	600cm	625cm	650cm	680cm	Width Drop
50cm	1107.95	1155.06	1202.27	1249.42	1296.53	1343.68	1390.87	1437.96	1485.14	1532.26	1579.41	1626.56	1673.72	1730.32	50cm
100cm	1257.63	1315.42	1373.28	1431.15	1488.99	1546.78	1604.66	1662.48	1720.30	1778.08	1835.91	1893.80	1951.61	2020.99	100cm
150cm	1407.29	1475.80	1544.31	1612.87	1681.37	1749.83	1818.40	1886.96	1955.42	2023.98	2092.56	2161.02	2229.51	2311.71	150cm
200cm	1556.94	1635.94	1715.33	1794.56	1873.77	1953.02	2032.22	2111.48	2190.70	2269.85	2349.07	2428.23	2507.42	2602.43	200cm
250cm	1706.61	1796.52	1886.40	1976.24	2066.17	2156.12	2246.05	2335.99	2425.96	2515.72	2605.60	2695.46	2785.31	2893.12	250cm
300cm	1856.21	1956.85	2057.47	2157.95	2258.57	2359.22	2459.87	2560.51	2661.23	2761.57	2862.11				300cm
350cm	2005.87	2117.17	2228.54	2339.62	2450.98	2562.32	2674.11	2785.01	2896.50	3007.47	3118.62				350cm
400cm	2155.52	2277.49	2399.61	2521.19	2643.36	2765.42	2887.51	3009.54	3131.79	3253.33	3375.16				400cm
450cm	2305.19	2437.81	2570.67	2702.87	2835.77	2968.54	3101.33	3234.05	3367.05	3499.20	3631.69				450cm
500cm	2454.85	4077.84	2741.73	2884.55	3028.16	3171.65	3317.77	3458.56	3602.31	3745.07	3888.21				500cm

#### Price Group 3R

**Aluscreen Futura**  
Deep  
Jumbotex  
Newlifescreeen Alu  
Multicolour Dimout

Width Drop	350cm	375cm	400cm	425cm	450cm	475cm	500cm	525cm	550cm	575cm	600cm	625cm	650cm	680cm	Width Drop
50cm	1359.06	1424.10	1489.25	1554.34	1619.43	1684.47	1749.57	1814.65	1879.76	1944.78	2009.90				50cm
100cm	1634.27	1719.02	1803.73	1888.49	1973.22	2057.90	2142.70	2227.42	2312.24	2396.90	2481.69				100cm
150cm	1909.44	2013.85	2118.28	2222.66	2327.10	2431.44	2535.84	2640.27	2744.62	2849.05	2953.45				150cm
200cm	2184.69	2308.75	2432.81	2556.87	2680.90	2804.97	2929.01	3053.05	3177.11	3301.19	3425.23				200cm
250cm	2459.90	2603.60	2747.34	2891.02	3034.68	3178.46	3322.21	3465.87	3609.60	3753.31	3897.04				250cm
300cm	2735.10	2898.46	3061.89	3225.18	3388.45	3551.98	3715.41	3878.65	4042.10	4205.43	4368.83				300cm
350cm	3010.28	3193.31	3377.29	3559.39	3742.25	3925.46	4108.59	4291.46	4474.58	4657.57	4840.62				350cm
400cm	3285.46	3488.15	3690.98	3893.44	4096.04	4298.97	4501.79	4704.24	4907.07	5109.68	5312.43				400cm
450cm	3560.67	3782.98	4005.52	4227.68	4449.81	4672.48	4894.97	5117.05	5339.57	5561.81	5784.21				450cm
500cm	3835.85	4077.84	4320.07	4561.90	4803.59	5045.99	5288.15	5529.82	5772.05	6013.92	6256.01				500cm

Side-Guiding: Side-guide wires with accessories: Please add £144.85 per double system.

#### Installation Profile

Provides an alternative to fitting to the wall or ceiling, supplied made to measure in grey, black or white £36.57 per m add on. Other custom colours available, pricing as per page 73.

Prices shown exclude VAT



# Roller Blind Systems

## SG 4840

Heavy duty chain operated Roller Blind system.  
 Tube diameter 80mm (up to 3.95m width).  
 Tube diameter 110mm (over 3.95m width).  
 Max. surface area 15m<sup>2</sup>

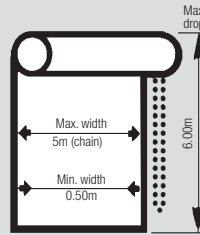

### SG 4840 complete with fabric

The prices below comprise the complete system made-to-measure, ready to hang with fabric of your choice. Please be aware that due to the size capabilities of this system, larger sizes can only be achieved by welding the fabric. Fabrics that can be welded are indicated below in bold print. Please consult application chart (page 57) to ensure that the fabric desired can be supplied in dimensions required.

Price Category C

#### Price Group 1R

- Basicscreen 1%
- Basicscreen 5%
- Basicscreen 10%
- Colorama 1
- Colorama 1 Alu
- Colorama 1 Bioactive
- Colorama 1 Eco
- Colorama 1 Multicolour
- Colorama Acoustic
- Colorama Acoustic Multicolour
- Element
- Puma**

Width ▶ Drop ▼	100cm	150cm	200cm	250cm	300cm	350cm	400cm	450cm	500cm	◀ Width ▼ Drop
50cm	851.59	948.74	1045.92	1142.99	1240.20	1337.29	1502.91	1599.98	1697.15	50cm
100cm	876.73	986.42	1096.21	1205.90	1315.61	1425.28	1603.51	1713.20	1822.94	100cm
150cm	901.88	1024.18	1146.46	1268.78	1391.04	1513.37	1704.12	1826.41	1948.66	150cm
200cm	927.01	1061.91	1196.80	1331.65	1466.46	1601.31	1804.76	1939.59	2074.46	200cm
250cm	952.27	1099.61	1247.06	1394.56	1541.92	1689.41	1905.30	2052.75	2200.21	250cm
300cm	977.33	1137.30	1297.40	1457.41	1617.39	1777.43	2005.87	2165.87	2325.82	300cm
350cm	1002.50	1175.03	1347.68	1520.27	1692.88	1865.44	2106.50			350cm
400cm	1027.69	1212.81	1397.99	1583.17	1768.36	1953.51				400cm
450cm	1052.81	1250.54	1448.29	1646.03	1843.76					450cm
500cm	1077.96	1288.24	1498.51	1708.92	1919.23					500cm
550cm	1103.11	1326.00	1548.86	1771.75						550cm
600cm	1128.29	1363.70	1599.15	1834.63						600cm
										Max. 15m <sup>2</sup>

#### Price Group 2R

- Alutex
- Atracor
- Colorama 2
- Colorama 2 Bioactive
- Colorama 2 Eco
- Colorama 2 Multicolour
- Mercuro
- Multi Visio
- Multishadow
- Multiscreen 1%**
- Multiscreen 5%**
- Multiscreen 10%**
- Newlifescreeen
- Nox
- Triscreen 1%
- Triscreen 3%
- Triscreen 5%
- Versascreen 1%**
- Versascreen 2%**
- Versascreen 5%**
- Versascreen 10%**
- Moon
- Reflex
- Safescreen

Width ▶ Drop ▼	100cm	150cm	200cm	250cm	300cm	350cm	400cm	450cm	500cm	◀ Width ▼ Drop
50cm	883.51	996.59	1109.73	1222.83	1335.94	1449.11	1630.62	1743.71	1856.82	50cm
100cm	924.58	1058.31	1191.95	1325.61	1459.27	1592.95	1795.09	1928.71	2062.40	100cm
150cm	965.76	1120.00	1274.18	1428.38	1582.61	1736.81	1959.53	2113.78	2268.01	150cm
200cm	1006.88	1181.64	1356.40	1531.25	1705.99	1880.78	2124.05	2298.80	2473.49	200cm
250cm	1047.97	1243.34	1438.66	1634.03	1829.29	2024.62	2288.52	2483.76	2679.09	250cm
300cm	1089.11	1305.00	1520.89	1736.73	1952.68	2168.51	2452.91	2668.78	2884.71	300cm
350cm	1130.22	1366.63	1603.07	1839.56	2076.01	2312.44	2617.36			350cm
400cm	1171.32	1428.32	1685.32	1942.35	2199.36	2456.36				400cm
450cm	1212.45	1489.95	1767.58	2045.14	2322.69					450cm
500cm	1253.54	1551.67	1849.84	2147.94	2446.05					500cm
550cm	1294.74	1613.36	1932.00	2250.71						550cm
600cm	1335.81	1675.05	2014.26	2353.48						600cm
										Max. 15m <sup>2</sup>

#### Price Group 3R

- Aluscreen Futura
- Deep
- Jumbotex
- Newlifescreeen Alu
- Multicolour Dimout

Width ▶ Drop ▼	100cm	150cm	200cm	250cm	300cm	350cm	400cm	450cm	500cm	◀ Width ▼ Drop
50cm	952.49	1100.14	1247.78	1395.33	1543.00	1690.55	1906.63	2054.27	2201.84	50cm
100cm	1028.08	1213.53	1398.98	1584.38	1769.78	1955.17	2209.12	2394.51	2579.89	100cm
150cm	1103.80	1326.97	1550.17	1773.41	1996.66	2219.93	2511.55	2734.76	2958.05	150cm
200cm	1179.38	1440.38	1701.47	1962.48	2223.48	2484.56	2814.05	3075.09	3336.10	200cm
250cm	1255.01	1553.83	1852.65	2151.55	2450.33	2749.18	3116.54	3415.34	3714.18	250cm
300cm	1330.60	1667.25	2003.92	2340.52	2677.22	3013.87	3418.93	3755.61	4092.32	300cm
350cm	1406.24	1780.69	2155.10	2529.63	2904.07	3278.50	3721.43			350cm
400cm	1481.81	1894.12	2306.41	2718.63	3130.93	3543.17				400cm
450cm	1557.49	2007.49	2457.59	2907.74	3357.76					450cm
500cm	1633.09	2120.97	2608.83	3096.72	3584.63					500cm
550cm	1708.69	2234.39	2760.11	3285.78						550cm
600cm	1784.29	2347.77	2911.26	3474.87						600cm
										Max. 15m <sup>2</sup>

Note: All fabrics are FR

Side-Guiding of SG 4840 Side-guide wires are available as an option. Please add £248.44 per system (Cat. 'C').

Prices shown exclude VAT



# Roller Blind Systems



## SG 4955

Battery operated  
Roller Blind system.  
Tube diameter 43mm.

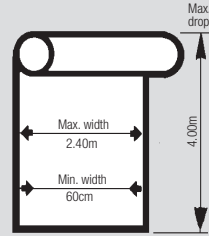

### SG 4955 complete with fabric

The prices below comprise the complete system made-to-measure, ready to hang with fabric of your choice. Please consult application chart (page 57 of our main price list) to ensure that fabric desired can be supplied in dimensions required.

#### Price Category C

#### Price Group 1R

- Basicscreen 1%
- Basicscreen 5%
- Basicscreen 10%
- Colorama 1
- Colorama 1 Alu
- Colorama 1 Bioactive
- Colorama 1 Eco
- Colorama 1 Multicolour
- Colorama Acoustic
- Colorama Acoustic Multicolour
- Element
- Puma

Width ▶ Drop ▼	60cm	80cm	100cm	120cm	140cm	160cm	180cm	200cm	220cm	240cm	◀ Width ▼ Drop
60cm	864.88	880.49	896.08	910.04	923.98	937.93	951.86	967.47	997.43	1013.04	60cm
80cm	869.31	886.23	903.15	918.52	933.91	949.31	964.64	981.55	1013.04	1029.96	80cm
100cm	873.75	891.97	910.19	927.00	943.82	960.68	977.40	995.65	1028.66	1046.89	100cm
120cm	878.18	897.70	917.26	935.48	953.71	972.06	990.21	1009.75	1044.28	1063.81	120cm
140cm	882.58	903.43	924.28	943.93	963.65	983.33	1003.01	1023.88	1059.87	1080.73	140cm
160cm	887.01	909.17	931.35	952.42	973.55	994.71	1015.79	1037.95	1075.47	1097.65	160cm
180cm	891.40	914.90	938.39	960.93	983.51	1006.06	1028.53	1052.01	1091.07	1114.56	180cm
200cm	895.84	920.63	945.46	969.42	993.42	1017.43	1041.31	1066.12	1106.66	1131.48	200cm
220cm	900.25	926.39	952.51	977.90	1003.34	1028.81	1054.08	1080.20	1122.31	1148.41	220cm
240cm	904.67	932.09	959.52	986.40	1013.22	1040.05	1066.93	1094.36	1137.87	1165.30	240cm
260cm	909.10	937.85	966.59	994.91	1023.14	1051.41	1079.71	1108.46	1153.47	1182.21	260cm
280cm	913.48	943.54	973.62	1003.35	1033.09	1062.74	1092.48	1122.58	1169.07	1199.15	280cm
300cm	917.91	949.29	980.66	1011.84	1043.01	1074.13	1105.28	1136.67	1184.66	1216.07	300cm
320cm	922.32	955.02	987.73	1020.33	1052.92	1085.53	1118.04	1150.75	1200.30	1232.98	320cm
340cm	926.75	960.75	994.78	1028.79	1062.80	1096.80	1130.78	1164.80	1215.89	1249.91	340cm
360cm	931.18	966.49	1001.83	1037.27	1072.70	1108.19	1143.56	1178.90	1231.51	1266.84	360cm
380cm	935.56	972.21	1008.89	1045.74	1082.57	1119.47	1156.32	1192.97	1247.11	1283.76	380cm
400cm	940.03	977.95	1015.92	1054.24	1092.51	1130.85	1169.09	1207.07	1262.70	1300.67	400cm

#### Price Group 2R

- Alutex
- Atracor
- Colorama 2
- Colorama 2 Bioactive
- Colorama 2 Eco
- Colorama 2 Multicolour
- Mercuro
- Multi Visio
- Multishadow
- Multiscreen 1%
- Multiscreen 5%
- Multiscreen 10%
- Newlifescreeen
- Nox
- Triscreen 1%
- Triscreen 3%
- Triscreen 5%
- Versascreen 1%
- Versascreen 2%
- Versascreen 5%
- Versascreen 10%
- Moon
- Reflex
- Safescreen

Width ▶ Drop ▼	60cm	80cm	100cm	120cm	140cm	160cm	180cm	200cm	220cm	240cm	◀ Width ▼ Drop
60cm	878.90	898.69	918.45	936.93	955.41	973.91	992.41	1012.18	1046.95	1066.71	60cm
80cm	886.13	908.03	929.95	950.81	971.62	992.50	1013.30	1035.23	1072.45	1094.38	80cm
100cm	893.32	917.41	941.48	964.69	987.83	1011.07	1034.21	1058.27	1097.94	1122.00	100cm
120cm	900.55	926.76	952.99	978.57	1004.04	1029.62	1055.09	1081.31	1123.43	1149.64	120cm
140cm	907.82	936.18	964.55	992.37	1020.28	1048.11	1075.99	1104.37	1148.93	1177.29	140cm
160cm	915.01	945.52	976.04	1006.26	1036.48	1066.67	1096.88	1127.40	1174.44	1204.96	160cm
180cm	922.22	954.92	987.57	1020.08	1052.63	1085.17	1117.78	1150.43	1199.93	1232.61	180cm
200cm	929.45	964.27	999.10	1033.97	1068.86	1103.75	1138.64	1173.47	1225.41	1260.25	200cm
220cm	936.65	973.66	1010.61	1047.83	1085.05	1122.33	1159.54	1196.50	1250.91	1287.89	220cm
240cm	943.92	983.02	1022.14	1061.65	1101.27	1140.79	1180.40	1219.55	1276.43	1315.50	240cm
260cm	951.14	992.41	1033.65	1075.53	1117.50	1159.35	1201.30	1242.57	1301.90	1343.16	260cm
280cm	958.27	1001.71	1045.14	1089.44	1133.64	1177.92	1222.21	1265.64	1327.40	1370.83	280cm
300cm	965.53	1011.09	1056.67	1103.28	1149.84	1196.47	1243.09	1288.67	1352.89	1398.47	300cm
320cm	972.73	1020.43	1068.15	1117.16	1166.02	1215.03	1263.99	1311.74	1378.40	1426.12	320cm
340cm	980.01	1029.88	1079.74	1131.07	1182.34	1233.56	1284.85	1334.72	1403.87	1453.74	340cm
360cm	987.21	1039.24	1091.27	1144.95	1198.53	1252.13	1305.75	1357.76	1429.38	1481.39	360cm
380cm	994.47	1048.64	1102.77	1158.80	1214.75	1265.85	1326.61	1380.79	1454.86	1509.04	380cm
400cm	1001.69	1057.99	1114.32	1172.68	1230.95	1314.54	1347.51	1403.84	1480.36	1536.67	400cm

#### Price Group 3R

- Aluscreen Futura
- Deep
- Jumbotex
- Newlifescreeen Alu
- Multicolour Dimout

Width ▶ Drop ▼	60cm	80cm	100cm	120cm	140cm	160cm	180cm	200cm	220cm	240cm	◀ Width ▼ Drop
60cm	909.18	937.97	966.77	995.10	1023.43	1051.73	1080.07	1108.86	1153.92	1182.73	60cm
80cm	922.46	955.20	987.97	1020.60	1053.21	1085.85	1118.48	1151.20	1200.82	1233.55	80cm
100cm	935.74	972.46	1009.17	1046.08	1083.01	1120.00	1156.89	1193.59	1247.70	1386.20	100cm
120cm	949.03	989.70	1030.34	1071.56	1112.78	1154.09	1195.33	1235.97	1294.59	1335.23	120cm
140cm	962.28	1006.88	1051.48	1097.04	1142.63	1188.20	1233.69	1278.31	1341.47	1386.08	140cm
160cm	975.56	1024.13	1072.69	1122.52	1172.42	1222.30	1272.12	1320.66	1388.38	1436.93	160cm
180cm	988.81	1041.35	1093.86	1148.05	1202.27	1256.40	1310.56	1363.06	1435.24	1487.77	180cm
200cm	1002.10	1058.57	1115.06	1173.55	1232.04	1290.53	1348.95	1405.45	1482.16	1538.64	200cm
220cm	1015.38	1075.79	1136.24	1199.04	1261.86	1324.61	1387.39	1447.81	1529.04	1589.48	220cm
240cm	1028.66	1093.06	1157.43	1224.52	1291.66	1358.77	1425.77	1490.16	1575.91	1640.30	240cm
260cm	1041.96	1110.28	1178.61	1250.03	1321.45	1392.88	1464.22	1532.54	1622.81	1691.17	260cm
280cm	1055.24	1127.53	1199.83	1275.55	1351.32	1426.94	1502.68	1574.96	1669.73	1742.02	280cm
300cm	1068.54	1144.77	1221.02	1301.03	1381.12	1461.09	1541.09	1617.33	1716.61	1792.87	300cm
320cm	1081.83	1162.00	1242.22	1326.53	1410.91	1495.22	1579.49	1659.70	1763.50	1843.71	320cm
340cm	1095.08	1179.27	1263.40	1352.04	1440.64	1529.25	1617.90	1702.08	1810.40	1894.55	340cm
360cm	1108.37	1196.48	1284.61	1377.52	1470.41	1563.39	1656.34	1744.44	1857.30	1945.40	360cm
380cm	1121.69	1213.74	1305.80	1403.04	1500.16	1597.42	1694.76	1786.80	1904.17	1996.22	380cm
400cm	1134.97	1230.97	1327.00	1428.54	1529.96	1631.55	1733.16	1829.17	1951.07	2047.09	400cm

#### SG 4955 Control Options (Category A)

- The above system includes the 10949 wall switch.
  - The above system is compatible with the below controls at an additional cost.
  - 10946 Radio hand-held transmitter 1 channel
  - 10947 Radio hand-held transmitter 2 + 1 channel
  - 10948 Radio hand-held transmitter 6 + 1 channel
  - 10950 Radio wall transmitter 2 channel
  - 10951 Radio wall transmitter 5 + 1 channel
  - 11429 Timer White
- Please see prices on page 28

Prices shown exclude VAT



# Roller Blind Systems

## SG 4960

Electric roller blind system.  
Mains voltage.  
Tube diameter 43mm  
Speed: 12cm/sec. approx.

\*Max surface area Single system: 9.6m<sup>2</sup>  
Double system: 19.2m<sup>2</sup>  
Max M<sup>2</sup> depends on fabric type

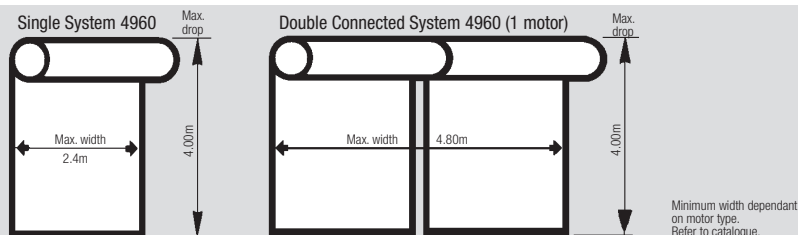

### SG 4960 complete with fabric

The prices below comprise the complete system made-to-measure, including series 20 mains switched motor (alternative motors see below). Ready to hang with fabric of your choice. Brackets, bracket covers, bottom bar and bottom bar endcaps supplied as standard in either white, grey or black. System sizes in shaded areas available as side-by-side systems only. Please consult application chart (page 57) to ensure that fabric desired can be supplied in dimensions required.

Price Category C

#### Price Group 1R

- Basicscreen 1% Element
- Basicscreen 5% Puma
- Basicscreen 10%
- Colorama 1
- Colorama 1 Alu
- Colorama 1 Bioactive
- Colorama 1 Eco
- Colorama 1 Multicolour
- Colorama Acoustic
- Colorama Acoustic Multicolour

Width ▶ ▼ Drop	100cm	125cm	150cm	175cm	200cm	225cm	240cm	250cm	275cm	300cm	325cm	350cm	375cm	400cm	425cm	450cm	460cm	480cm
50cm	1050.05	1070.02	1090.00	1109.93	1129.90	1149.86	1181.86	1209.92	1229.84	1249.75	1269.76	1289.71	1309.00	1328.23	1347.50	1369.86	1378.17	1394.80
100cm	1070.83	1095.95	1121.08	1146.31	1171.35	1196.43	1231.62	1261.74	1286.88	1311.97	1337.13	1362.24	1387.45	1412.53	1437.70	1462.88	1472.91	1493.06
150cm	1091.53	1121.83	1152.18	1182.55	1212.86	1243.15	1281.39	1313.57	1343.83	1374.15	1404.47	1434.80	1465.16	1495.51	1525.79	1556.17	1568.24	1592.44
200cm	1112.30	1147.79	1183.34	1218.86	1254.26	1289.69	1331.14	1365.41	1400.84	1436.38	1471.87	1507.37	1542.94	1578.37	1613.90	1649.39	1663.58	1691.94
250cm	1133.03	1173.74	1214.38	1255.07	1295.75	1336.48	1380.87	1417.21	1457.86	1498.50	1539.20	1579.89	1620.61	1661.31	1702.00	1742.61	1758.95	1791.52
300cm	1153.71	1199.62	1245.56	1291.37	1337.26	1383.11	1430.66	1469.06	1514.91	1560.79	1606.65	1652.47	1698.38	1744.23	1790.13	1835.83	1854.30	1891.05
350cm	1174.47	1225.55	1276.57	1327.62	1378.62	1429.67	1480.43	1520.86	1571.97	1622.99	1674.05	1725.03	1776.12	1827.19	1878.24	1929.05	1949.66	1990.59
400cm	1195.21	1251.42	1307.62	1363.88	1420.06	1476.24	1530.21	1572.67	1629.04	1682.94	1741.50	1797.58	1853.88	1910.15	1966.35	2022.27	2045.01	2090.13

#### Price Group 2R

- Alutex Nox
- Atracor Triscreen 1%
- Colorama 2 Triscreen 3%
- Colorama 2 Bioactive Triscreen 5%
- Colorama 2 Eco Versascreen 1%
- Colorama 2 Multicolour Versascreen 2%
- Mercuro Versascreen 5%
- Multi Visio Versascreen 10%
- Multishadow Moon
- Multiscreen 1% Reflex
- Multiscreen 5% Safescreen
- Multiscreen 10%
- Newlifescreeen

Width ▶ ▼ Drop	100cm	125cm	150cm	175cm	200cm	225cm	240cm	250cm	275cm	300cm	325cm	350cm	375cm	400cm	425cm	450cm	460cm	480cm
50cm	1073.75	1099.61	1125.47	1151.35	1177.24	1203.96	1238.69	1269.00	1294.87	1320.75	1346.65	1372.54	1398.43	1424.27	1450.16	1476.04	1486.41	1507.12
100cm	1107.61	1142.02	1176.33	1210.72	1245.01	1279.29	1320.00	1353.81	1388.10	1422.42	1456.78	1491.13	1525.48	1559.81	1594.20	1628.50	1642.25	1669.79
150cm	1141.53	1184.34	1227.17	1269.97	1312.77	1355.60	1401.34	1438.50	1481.28	1524.12	1566.89	1609.73	1652.51	1695.32	1738.13	1780.94	1798.09	1832.37
200cm	1175.41	1226.69	1277.94	1329.25	1380.56	1431.90	1482.64	1523.19	1574.43	1625.68	1677.02	1728.29	1779.59	1830.87	1881.92	1933.45	1953.97	1995.02
250cm	1209.31	1269.00	1328.79	1388.50	1448.30	1508.10	1563.94	1607.86	1667.64	1727.37	1787.15	1846.92	1906.66	1966.37	2026.09	2085.97	2109.79	2157.47
300cm	1243.13	1311.40	1379.56	1447.81	1516.09	1584.32	1645.24	1692.58	1760.82	1828.99	1897.26	1965.45	2033.68	2101.99	2170.09	2238.48	2265.65	2320.05
350cm	1277.06	1353.81	1430.44	1507.13	1583.80	1660.48	1726.54	1777.25	1854.01	1930.69	2007.35	2084.03	2160.72	2237.44	2314.10	2391.00	2421.50	2482.60
400cm	1310.95	1396.18	1481.33	1566.22	1651.55	1736.66	1807.85	1861.95	1947.22	2032.42	2117.49	2202.60	2287.78	2372.92	2458.16	2543.51	2577.35	2645.15

#### Price Group 3R

- Aluscreen Futura
- Deep
- Jumbotex
- Newlifescreeen Alu
- Multicolour Dimout

Width ▶ ▼ Drop	100cm	125cm	150cm	175cm	200cm	225cm	240cm	250cm	275cm	300cm	325cm	350cm	375cm	400cm	425cm	450cm	460cm	480cm
50cm	1124.90	1163.62	1202.29	1240.89	1279.60	1318.31	1361.53	1397.00	1435.66	1474.36	1513.01	1551.66	1590.29	1628.98	1667.64	1706.34	1721.82	1752.82
100cm	1187.23	1241.46	1295.70	1350.00	1404.22	1458.47	1511.06	1552.79	1607.06	1661.24	1715.56	1769.78	1824.05	1878.24	1932.50	1986.76	2008.43	2051.74
150cm	1249.52	1319.32	1389.20	1459.05	1528.82	1598.59	1660.59	1708.58	1778.41	1848.24	1918.00	1987.85	2057.70	2127.53	2197.37	2267.16	2295.08	2350.88
200cm	1311.73	1397.26	1482.69	1568.08	1653.46	1738.87	1810.16	1864.31	1949.76	2035.15	2120.55	2205.95	2291.34	2376.75	2462.16	2547.56	2581.74	2650.09
250cm	1374.15	1475.15	1576.17	1677.15	1778.05	1878.95	1959.70	2020.11	2121.06	2222.06	2323.05	2424.02	2525.00	2625.99	2726.98	2827.95	2868.42	2949.28
300cm	1436.49	1553.05	1669.69	1786.18	1902.75	2019.29	2109.23	2175.91	2292.45	2409.03	2525.61	2642.09	2758.68	2875.19	2991.06	3108.35	3155.09	3248.48
350cm	1498.84	1630.94	1763.04	1895.20	2027.36	2159.56	2258.79	2331.67	2463.77	2595.93	2728.07	2860.27	2992.30	3124.49	3256.61	3388.74	3441.76	3547.68
400cm	1561.15	1708.85	1856.43	2004.18	2151.97	2299.79	2408.36	2487.43	2635.03	2782.83	2930.51	3078.44	3225.98	3373.81	3522.16	3669.14	3728.43	3846.88

#### SG 4960 Control Options

Standard Radio Controlled option – with System 9940, see page 28.

Series 40 motors –With integrated radio receiver for operation with SG wireless system 9940 – add on £254.88 per system, see page 28.

NOTE: 24v Series 40 Motors are not supplied with power supplies (transformers) as standard. They must be ordered separately, see page 28.

Series 50 SMART by Silent Gliss motors – for use with Silent Gliss Gateway and associated components – add on £254.88 per system, see page 28.

Note: If a double connected system is required below 2.30m (e.g. for fabric reasons) please add £54.30 to single system price.

For side guided option (with white, grey or black accessories) add £85.22 per system. For double systems add £170.44

#### Installation Profile

Provides an alternative to fitting to the wall or ceiling, supplied made to measure in silver or white £36.57 per m add on. Other custom colours available, pricing as per page 73.

4960 LV 24V DC – LV1/LV2/LV3 (optional) – supplement £233.24.

Prices shown exclude VAT

# Roller Blind Systems



## SG 4970

Heavy duty electrically operated Roller Blind system. Mains voltage. Speed approx. 7cm/sec. Tube diameter 60mm.

\*Max. surface area 17m<sup>2</sup>  
\*Max. m<sup>2</sup> depends on fabric type.

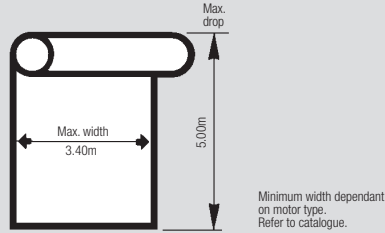

## SG 4970 complete with fabric

The prices below comprise the complete system made-to-measure, including series 20 mains switched motor (alternative motors see below). Ready to hang with fabric of your choice. Brackets, bracket covers, bottom bar and bottom bar endcaps supplied as standard in either white, grey or black. Please be aware that due to the size capabilities of this system, larger sizes can only be achieved by welding the fabric. Fabrics that can be welded are indicated below in bold print. Please consult application chart (page 57) to ensure that fabric desired can be supplied in dimensions required.

### Price Category C

#### Price Group 1R

**Basicscreen 1%**  
**Basicscreen 5%**  
**Basicscreen 10%**  
Colorama 1  
Colorama 1 Alu  
Colorama 1 Bioactive  
Colorama 1 Eco  
Colorama 1 Multicolour  
Colorama Acoustic  
Colorama Acoustic Multicolour  
Element  
**Puma**

Width Drop	100cm	125cm	150cm	175cm	200cm	225cm	250cm	275cm	300cm	325cm	340cm	Width Drop
50cm	1463.60	1493.47	1523.35	1553.24	1583.09	1612.92	1642.82	1672.70	1702.54	1732.42	1750.34	50cm
100cm	1489.54	1525.83	1562.20	1598.56	1634.90	1671.21	1707.56	1743.89	1780.21	1816.54	1838.33	100cm
150cm	1515.44	1558.25	1601.05	1643.87	1686.67	1729.46	1772.24	1815.08	1857.90	1900.71	1926.40	150cm
200cm	1541.31	1590.57	1639.84	1689.16	1738.45	1787.72	1836.98	1886.26	1935.59	1984.86	2014.43	200cm
250cm	1567.21	1622.98	1678.71	1734.47	1790.23	1845.92	1901.72	1957.52	2013.25	2068.98	2102.43	250cm
300cm	1593.10	1655.30	1717.57	1779.75	1841.99	1904.27	1966.49	2028.70	2090.92	2153.17	2190.51	300cm
350cm	1619.01	1687.68	1756.41	1825.11	1893.81	1962.48	2031.14	2099.91	2168.55	2237.26	2278.50	350cm
400cm	1644.86	1720.07	1795.21	1870.43	1945.58	2020.74	2095.94	2171.10	2246.25	2321.42	2366.52	400cm
450cm	1670.78	1752.37	1834.09	1915.70	1997.38	2078.98	2160.67	2242.31	2323.96	2405.59	2454.57	450cm
500cm	1696.63	1784.75	1872.91	1961.01	2049.12	2137.26	2225.42	2313.45	2395.40	2489.75	2542.61	500cm

#### Price Group 2R

Alutex  
Atracor  
Colorama 2  
Colorama 2 Bioactive  
Colorama 2 Eco  
Colorama 2 Multicolour  
Mercurio  
Multi Visio  
Multishadow  
**Multiscreen 1%**  
**Multiscreen 5%**  
**Multiscreen 10%**  
Newlifescreeen

Nox  
**Triscreen 1%**  
**Triscreen 3%**  
**Triscreen 5%**  
**Versascreen 1%**  
**Versascreen 2%**  
**Versascreen 5%**  
**Versascreen 10%**  
Moon  
Reflex  
Safescreen

Width Drop	100cm	125cm	150cm	175cm	200cm	225cm	250cm	275cm	300cm	325cm	340cm	Width Drop
50cm	1480.11	1514.03	1548.04	1582.01	1616.02	1649.96	1683.95	1717.91	1751.93	1785.89	1806.25	50cm
100cm	1522.45	1567.02	1611.55	1656.11	1700.74	1745.25	1789.83	1834.36	1878.94	1923.54	1806.25	100cm
150cm	1564.81	1619.94	1675.10	1730.24	1785.39	1840.52	1895.68	1950.86	2006.02	2061.13	2094.22	150cm
200cm	1607.14	1672.90	1738.62	1804.35	1870.08	1935.79	2001.57	2067.28	2133.06	2198.76	2238.20	200cm
250cm	1649.46	1725.81	1802.13	1878.47	1954.81	2031.09	2107.42	2183.72	2260.05	2336.38	2382.16	250cm
300cm	1691.81	1778.75	1865.65	1952.60	2039.45	2126.39	2213.29	2300.23	2387.15	2474.04	2526.17	300cm
350cm	1734.17	1831.63	1929.17	2026.67	2145.38	2221.68	2319.19	2416.66	2514.22	2611.67	2670.17	350cm
400cm	1776.54	1884.60	1992.74	2100.77	2208.89	2316.97	2425.05	2533.13	2641.18	2749.28	2814.14	400cm
450cm	1818.90	1937.52	2056.21	2174.91	2293.56	2412.23	2530.95	2649.58	2768.28	2886.86	2958.02	450cm
500cm	1861.16	1990.52	2119.75	2249.04	2378.26	2507.49	2636.77	2766.09	2895.40	3024.46	3101.88	500cm

#### Price Group 3R

**Aluscreen Futura**  
Deep  
Jumbotex  
Newlifescreeen Alu  
Multicolour Dimout

Width Drop	100cm	125cm	150cm	175cm	200cm	225cm	250cm	275cm	300cm	325cm	340cm	Width Drop
50cm	1515.65	1558.43	1601.29	1644.22	1687.04	1729.93	1772.74	1815.58	1858.53			50cm
100cm	1593.48	1655.83	1718.16	1780.48	1842.82	1905.15	1967.45	2029.78	2092.13			100cm
150cm	1671.39	1753.17	1834.98	1916.74	1998.52	2080.41	2162.17	2243.90	2325.78			150cm
200cm	1749.22	1850.52	1951.76	2053.06	2154.32	2255.54	2356.84	2458.12	2559.36			200cm
250cm	1827.14	1947.87	2068.57	2189.32	2310.07	2430.79	2551.53	2672.29	2793.04			250cm
300cm	1904.99	2045.18	2185.41	2325.61	2465.82	2606.02	2746.23	2886.37	3026.59			300cm
350cm	1982.88	2142.51	2302.21	2461.85	2621.58	2781.23	2940.90	3100.55	3260.25			350cm
400cm	2060.73	2239.86	2419.02	2598.14	2777.34	2956.46	3135.62	3314.75	3493.89			400cm
450cm	2138.64	2337.19	2535.84	2734.43	2933.08	3131.68	3330.28	3528.88	3727.53			450cm
500cm	2216.46	2434.56	2652.69	2870.69	3088.84	3306.85	3524.96	3743.06	3961.16			500cm

#### SG 4970 Control Options

**Standard Radio Controlled option** – With System 9940, see page 28.

**Series 40 motors** – With integrated radio receiver for operation with SG wireless system 9940 – add on £254.88 per system, see page 28.

**NOTE:** 24v Series 40 Motors are not supplied with power supplies (transformers) as standard. They must be ordered separately.

**Series 50 SMART by Silent Gliss motors** – for use with Silent Gliss Gateway and associated components – add on £254.88 per system, see page 28.

**Side-Guiding:** Side-guide wires with accessories: Please add £91.92 per system.

#### Installation Profile

Provides an alternative to fitting to the wall or ceiling, supplied made to measure in grey, black or white £36.57 per m add on. Other custom colours available, pricing as per page 73.



# Roller Blind Systems

## SG 4970 – Double Connected System

Heavy duty electrically operated Roller Blind system. Mains voltage. Speed approx. 7cm/sec. Tube diameter 60mm.

Max. surface area 34m<sup>2</sup>(17m<sup>2</sup>for each panel of side by side system)

\*Max. m<sup>2</sup>depends on fabric type.

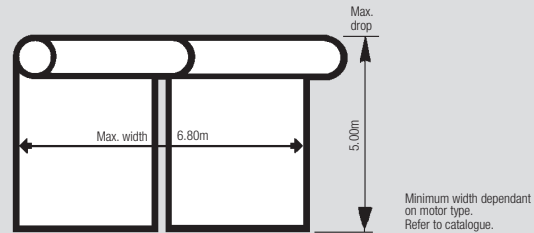

## SG 4970 – Double Connected System

The prices below comprise the complete system made-to-measure, including series 20 mains switched motor (alternative motors see below). Ready to hang with fabric of your choice. Brackets, bracket covers, bottom bar and bottom bar endcaps supplied as standard in either white, grey or black. Please be aware that due to the size capabilities of this system, larger sizes can only be achieved by welding the fabric. Fabrics that can be welded are indicated below in bold print. If a system is required as a double system smaller than widths indicated below, please add £111.86 to single system price. Please consult application chart (page 57) to ensure that fabric desired can be supplied in dimensions required.

### Price Category C

#### Price Group 1R

**Basicscreen 1%**  
**Basicscreen 5%**  
**Basicscreen 10%**  
Colorama 1  
Colorama 1 Alu  
Colorama 1 Bioactive  
Colorama 1 Eco  
Colorama 1 Multicolour  
Colorama Acoustic  
Colorama Acoustic Multicolour  
Element  
Puma

Width Drop	350cm	375cm	400cm	425cm	450cm	475cm	500cm	525cm	550cm	575cm	600cm	625cm	650cm	680cm	Width Drop
50cm	1908.67	1938.56	1968.47	1998.34	2028.20	2058.02	2087.90	2117.79	2147.61	2177.49	2207.35	2237.21	2267.08	2302.94	50cm
100cm	1999.31	2035.66	2072.01	2108.37	2144.68	2181.03	2217.39	2253.70	2290.04	2326.38	2362.70	2399.05	2435.37	2478.96	100cm
150cm	2089.93	2132.72	2175.55	2218.37	2261.18	2303.98	2346.81	2389.61	2432.42	2475.17	2518.07	2560.89	2603.68	2654.97	150cm
200cm	2180.61	2229.87	2279.15	2328.44	2377.69	2426.95	2476.25	2525.57	2574.85	2624.16	2673.38	2722.63	2771.94	2831.10	200cm
250cm	2271.19	2326.98	2382.71	2438.46	2494.22	2549.94	2605.72	2661.54	2717.23	2773.00	2828.72	2884.52	2940.23	3007.10	250cm
300cm	2361.82	2424.04	2486.32	2548.50	2610.72	2672.96	2735.19	2797.41	2859.60	2921.85	2984.09	3046.30	3108.51	3182.81	300cm
350cm	2452.46	2521.13	2589.85	2658.55	2727.25	2795.87	2864.67	2933.29	3002.05	3070.74	3139.46	3208.14	3276.79	3359.15	350cm
400cm	2543.04	2618.22	2693.44	2768.48	2843.74	2918.93	2994.10	3069.26	3144.43	3219.64	3294.81	3369.73	3445.07	3535.49	400cm
450cm	2633.66	2715.32	2796.99	2878.65	2960.30	3041.94	3123.56	3205.22	3286.80	3368.54	3450.41	3531.31	3613.36	3711.81	450cm
500cm	2724.26	2812.44	2900.54	2988.66	3076.76	3164.96	3253.02	3341.19	3429.19	3517.44	3605.47	3692.89	3781.65	3888.14	500cm

#### Price Group 2R

Alutex  
Atracor  
Colorama 2  
Colorama 2 Bioactive  
Colorama 2 Eco  
Colorama 2 Multicolour  
Mercurio  
Multi Visio  
Multishadow  
Multiscreen 1%  
Multiscreen 5%  
Multiscreen 10%  
Newlifescreeen

Nox  
**Triscreen 1%**  
**Triscreen 3%**  
**Triscreen 5%**  
**Versascreen 1%**  
**Versascreen 2%**  
**Versascreen 5%**  
**Versascreen 10%**  
Moon  
Reflex  
Safescreen

Width Drop	350cm	375cm	400cm	425cm	450cm	475cm	500cm	525cm	550cm	575cm	600cm	625cm	650cm	680cm	Width Drop
50cm	1966.30	2000.24	2034.24	2068.26	2102.21	2136.19	2170.11	2204.17	2238.13	2272.11	2306.06	2340.06	2374.07	2414.89	50cm
100cm	2114.51	2159.10	2204.16	2248.21	2292.79	2337.34	2381.91	2426.47	2471.05	2515.58	2560.19	2604.72	2649.28	2702.75	100cm
150cm	2262.75	2317.89	2373.05	2428.18	2483.35	2538.51	2593.65	2648.77	2703.91	2759.05	2814.23	2869.37	2924.55	2990.80	150cm
200cm	2410.97	2476.70	2542.46	2608.16	2673.87	2739.68	2805.42	2871.13	2936.88	3002.60	3068.33	3134.14	3199.82	3278.67	200cm
250cm	2559.18	2635.52	2711.84	2788.15	2864.47	2940.85	3017.11	3093.44	3169.75	3246.12	3322.43	3398.77	3475.08	3566.66	250cm
300cm	2707.38	2794.30	2881.20	2968.13	3055.02	3142.00	3228.87	3315.78	3402.73	3489.60	3576.52	3663.43	3750.36	3854.64	300cm
350cm	2855.63	2953.07	3050.66	3148.12	3245.65	3343.12	3440.60	3538.12	3635.55	3733.10	3830.58	3928.08	4025.63	4142.67	350cm
400cm	3003.82	3111.96	3219.98	3328.08	3436.20	3544.28	3652.33	3760.52	3868.50	3976.63	4084.64	4192.71	4300.90	4430.70	400cm
450cm	3152.04	3270.72	3389.41	3508.06	3626.75	3745.41	3864.08	3982.76	3286.80	4220.16	4338.67	4457.36	4576.15	450cm	
500cm	3300.25	3429.55	3558.84	3688.04	3817.31	3946.51	4075.83	4205.04	3429.19	4463.69	4592.71	4721.99	450cm		

#### Price Group 3R

**Aluscreen Futura**  
Deep  
Jumbotex  
Newlifescreeen Alu  
Multicolour Dimout

Width Drop	350cm	375cm	400cm	425cm	450cm	475cm	500cm	525cm	550cm	575cm	600cm	625cm	650cm	680cm	Width Drop
50cm	2090.64	2133.46	2176.38	2219.26	2262.11	2304.94	2347.77	2390.60	2433.43	2476.26	2519.09	2561.92	2604.75	2647.58	50cm
100cm	2363.21	2425.54	2487.87	2550.18	2612.56	2674.88	2737.20	2799.52	2861.84	2924.18	2986.50	3048.82	3111.14	3173.46	100cm
150cm	2635.77	2717.12	2799.40	2881.18	2963.00	3044.74	3126.55	3208.33	3290.15	3371.94	3453.74	3535.53	3617.32	3699.11	150cm
200cm	2908.35	3009.60	3110.88	3212.15	3313.38	3414.66	3515.95	3617.16	3718.45	3819.74	3921.03	4022.32	4123.61	4224.90	200cm
250cm	3180.89	3301.62	3422.39	3543.09	3663.82	3784.60	3905.27	4026.04	4146.80	4267.55	4388.25	4508.95	4629.65	4750.35	250cm
300cm	3453.49	3593.64	3733.88	3874.10	4014.31	4154.51	4294.72	4434.86	4575.11	4715.28	4855.44	4995.60	5135.76	5275.92	300cm
350cm	3726.09	3885.71	4045.40	4205.05	4364.72	4524.37	4684.06	4843.77	5003.40	5163.11	5322.77	5482.48	5642.19	5801.90	350cm
400cm	3998.60	4177.75	4356.88	4536.02	4715.11	4894.27	5073.45	5252.60	5431.75	5610.87	5790.00	5969.12	6148.24	6327.36	400cm
450cm	4271.16	4469.72	4668.39	4867.01	5065.59	5264.20	5462.80	5662.72	5860.08	6058.64	5789.97	6277.12	6475.24	6673.36	450cm
500cm	4543.66	4761.85	4979.92	5197.99	5416.04	5634.12	5852.13	6070.25	6288.43	6506.39	6724.76	6943.12	7161.48	7379.84	500cm

SG 4970 Double Connected System Control Options Standard Radio Controlled option – With System 9940, see page 28.

Series 40 motors –With integrated radio receiver for operation with SG wireless system 9940 – add on £254.88 per system, see page 28.

NOTE: 24v Series 40 Motors are not supplied with power supplies (transformers) as standard. They must be ordered separately, see page 28.

Series 50 SMART by Silent Gliss motors – for use with Silent Gliss Gateway and associated components – add on £254.88 per system, see page 28.

Side-Guiding:

Side-guide wires with accessories: Please add £143.53 per side-by-side system.

#### Installation Profile

Provides an alternative to fitting to the wall or ceiling, supplied made to measure in grey, black or white £36.57 per m add on. Other custom colours available, pricing as per page 73.

# Roller Blind Systems



## SG 4880

Heavy duty electrically operated Roller Blind system. Mains voltage. Speed approx. 7cm/sec.

Max. surface area 36m<sup>2</sup>

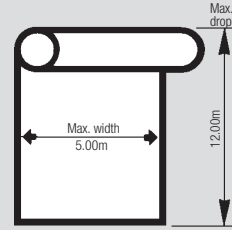

Minimum width dependant on motor type. Refer to catalogue.

### SG 4880 complete with fabric

The prices below comprise the complete system made-to-measure, including series 20 mains switched motor (alternative motors see below). Ready to hang with fabric of your choice. Please be aware that due to the size capabilities of this system, larger sizes can only be achieved by welding the fabric. Fabrics that can be welded are indicated over in bold print. Please consult application chart (page 57) to ensure that fabric desired can be supplied in dimensions required.

#### Price Group 1R

#### Price Category 'C'

Width Drop	100cm	150cm	200cm	250cm	300cm	350cm	400cm	450cm	500cm	Width Drop
50cm	1689.30	1786.43	1883.63	1980.76	2077.91	2175.04	2272.18	2369.28	2466.48	50cm
100cm	1714.50	1824.21	1933.95	2043.61	2153.32	2263.09	2372.79	2482.52	2592.21	100cm
150cm	1739.63	1861.93	1984.20	2106.49	2228.83	2351.07	2473.39	2595.68	2717.97	150cm
200cm	1764.77	1899.63	2034.52	2169.38	2304.29	2439.10	2574.02	2708.82	2843.72	200cm
250cm	1789.93	1937.38	2084.82	2232.25	2379.70	2527.15	2674.58	2822.01	2969.47	250cm
300cm	1815.08	1975.11	2135.17	2295.14	2455.14	2615.16	2775.20	2935.25	3095.19	300cm
350cm	1840.24	2012.81	2185.42	2358.02	2530.61	2703.16	2875.78	3048.37	3220.96	350cm
400cm	1865.37	2050.55	2235.74	2420.86	2606.11	2791.25	2976.41	3161.59	3346.76	400cm
450cm	1890.53	2088.25	2286.00	2483.76	2681.51	2879.25	3077.02	3274.72	3472.48	450cm
500cm	1915.69	2126.02	2336.30	2546.66	2756.97	2967.29	3177.56	3387.98	3598.22	500cm
550cm	1940.87	2163.73	2386.60	2609.48	2832.44	3055.29	3278.19	3501.11	3723.98	550cm
600cm	1966.00	2201.47	2436.90	2672.37	2907.85	3143.32	3378.80	3614.25	3849.72	600cm
650cm	1991.18	2239.17	2487.14	2735.27	2983.31	3231.35	3479.39	3727.44		650cm
700cm	2016.33	2276.92	2537.48	2798.12	3058.80	3319.39	3580.01	3840.61		700cm
750cm	2041.49	2314.63	2587.79	2861.00	3134.25	3407.43	3680.61	3953.80		750cm
800cm	2066.64	2352.34	2638.11	2923.90	3209.66	3495.44	3781.20	4066.96		800cm
850cm	2091.75	2390.14	2688.39	2986.73	3285.14	3583.46	3881.74			850cm
900cm	2116.92	2427.82	2738.71	3049.62	3360.60	3671.48	3982.33			900cm
950cm	2142.04	2465.53	2788.99	3112.50	3436.03	3759.54				950cm
1000cm	2167.14	2503.31	2839.35	3175.43	3511.52	3847.49				1000cm
1050cm	2192.34	2541.00	2889.61	3238.28	3587.00					1050cm
1100cm	2217.49	2578.73	2939.93	3301.19	3662.42					1100cm
1150cm	2242.66	2616.46	2990.23	3364.02	3737.82					1150cm
1200cm	2267.75	2654.15	3040.58	3426.92	3813.26					1200cm

#### Price Group 2R

Width Drop	100cm	150cm	200cm	250cm	300cm	350cm	400cm	450cm	500cm	Width Drop
50cm	1721.28	1834.36	1947.43	2060.63	2173.74	2286.80	2399.86	2513.04	2626.07	50cm
100cm	1762.36	1896.04	2029.70	2163.41	2297.04	2430.72	2564.33	2698.05	2831.70	100cm
150cm	1803.48	1957.74	2111.89	2266.14	2420.35	2574.60	2728.82	2883.05	3037.26	150cm
200cm	1844.57	2019.40	2194.14	2368.95	2543.68	2718.53	2893.28	3068.07	3242.81	200cm
250cm	1885.71	2081.03	2276.39	2471.73	2667.09	2862.43	3057.75	3253.12	3448.40	250cm
300cm	1926.85	2142.73	2358.61	2574.51	2790.41	3006.29	3222.16	3438.11	3654.00	300cm
350cm	1967.97	2204.39	2440.80	2677.29	2913.77	3150.23	3386.65	3623.11	3859.59	350cm
400cm	2009.04	2266.03	2523.08	2780.06	3037.08	3294.12	3551.08	3808.15	4065.13	400cm
450cm	2050.19	2327.78	2605.31	2882.90	3160.47	3438.03	3715.57	3993.11	4270.68	450cm
500cm	2091.28	2389.45	2687.58	2985.68	3283.75	3581.88	3880.03	4178.18	4476.28	500cm
550cm	2132.40	2451.11	2769.75	3088.41	3407.16	3725.81	4044.51	4363.17	4681.87	550cm
600cm	2173.52	2512.76	2851.99	3191.25	3530.46	3869.69	4208.92	4548.18	4887.44	600cm
650cm	2214.61	2574.42	2934.20	3294.00	3653.85	4013.54	4373.42	4733.19		650cm
700cm	2255.74	2636.14	3016.42	3396.79	3777.13	4157.47	4537.85	4918.22		700cm
750cm	2296.85	2697.76	3098.67	3499.54	3900.53	4301.39	4702.34	5103.21		750cm
800cm	2337.96	2759.47	3180.89	3602.36	4023.84	4445.33	4866.74	5288.24		800cm
850cm	2379.15	2821.11	3263.10	3705.18	4147.15	4589.23	5031.27			850cm
900cm	2420.20	2882.77	3345.33	3807.96	4270.53	4733.12	5195.71			900cm
950cm	2461.32	2944.42	3427.58	3910.72	4393.89	4877.05				950cm
1000cm	2502.44	3006.14	3509.85	4013.50	4517.21	5020.94				1000cm
1050cm	2543.55	3067.82	3592.08	4116.32	4640.61					1050cm
1100cm	2584.66	3129.51	3674.30	4219.16	4763.87					1100cm
1150cm	2625.82	3191.14	3756.53	4321.89	4887.26					1150cm
1200cm	2666.89	3252.82	3838.77	4424.68	5010.61					1200cm

#### Price Group 3R

Width Drop	100cm	150cm	200cm	250cm	300cm	350cm	400cm	450cm	500cm	Width Drop
50cm	1790.29	1937.89	2085.48	2233.13	2380.72	2528.32	2675.92	2823.52	2971.12	50cm
100cm	1865.89	2051.30	2236.75	2422.10	2607.54	2793.03	2978.38	3163.81	3349.23	100cm
150cm	1941.51	2164.74	2387.92	2611.18	2834.42	3057.66	3280.82	3504.08	3727.27	150cm
200cm	2017.13	2278.17	2539.15	2800.22	3061.23	3322.28	3583.36	3844.31	4105.38	200cm
250cm	2092.72	2391.58	2690.39	2989.24	3288.10	3587.00	3885.78	4184.68	4483.41	250cm
300cm	2168.35	2505.06	2841.65	3178.33	3514.97	3851.60	4188.26	4524.93	4861.54	300cm
350cm	2243.90	2618.42	2992.84	3367.33	3741.80	4116.29	4490.71	4865.17	5239.60	350cm
400cm	2319.58	2731.86	3144.16	3556.40	3968.63	4380.92	4793.18	5205.44	5617.68	400cm
450cm	2395.20	2845.27	3295.37	3745.42	4195.47	4645.61	5095.68	5545.75	5995.81	450cm
500cm	2470.82	2958.71	3446.58	3934.51	4422.33	4910.24	5398.16	5886.03	6373.90	500cm
550cm	2546.42	3072.11	3597.80	4123.48	4649.27	5174.93	5700.52	6226.27	6751.95	550cm
600cm	2622.03	3185.56	3749.04	4312.56	4876.03	5439.55	6003.07	6566.59	7130.02	600cm
650cm	2697.68	3299.02	3900.30	4501.56	5102.94	5704.17	6305.48	6906.84		650cm
700cm	2773.21	3412.39	4051.49	4690.61	5329.75	5968.90	6608.04	7247.07		700cm
750cm	2848.91	3525.81	4202.74	4879.67	5556.64	6233.57	6910.48	7587.43		750cm
800cm	2924.52	3639.23	4353.99	5068.74	5783.49	6498.24	7212.94	7927.63		800cm
850cm	3000.15	3752.69	4505.25	5257.76	6010.35	6762.87	7515.41			850cm
900cm	3075.74	3866.15	4656.41	5446.75	6237.15	7027.53	7817.84			900cm
950cm	3151.37	3979.53	4807.70	5635.87	6464.01	7292.17				950cm
1000cm	3226.98	4092.95	4958.90	5824.87	6690.85	7556.83				1000cm
1050cm	3302.61	4206.41	5110.13	6013.91	6917.73					1050cm
1100cm	3378.22	4319.79	5261.37	6203.00	7144.55					1100cm
1150cm	3453.87	4433.22	5412.56	6391.98	7371.40					1150cm
1200cm	3529.42	4546.65	5563.82	6581.08	7598.27					1200cm

Side-Guiding of SG 4880 Side-guide wires are available as an option. Please add £248.45 per system (Cat. 'C').

Prices shown exclude VAT

System Control Options – Radio control standard option is with System 9940, see page 28.

Series 40 motors – With integrated radio receiver for operation with SG wireless system 9940 – add on £326.77 per system, see page 28.

NOTE: 24v Series 40 Motors are not supplied with power supplies (transformers) as standard. They must be ordered separately, see page 28.

Series 50 SMART by Silent Gliss motors – for use with Silent Gliss Gateway and associated components – add on £326.77 per system, see page 28.





# Roller Blind Systems

## SG Roller Blind Box / Fascia

Supplied in white or black (Other RAL finishes available - see page 73 of the main price list)

For use on systems 4910, 4960, 4930 and 4970

Optional side channels available for 4960/4970 systems with fascia round, square or box

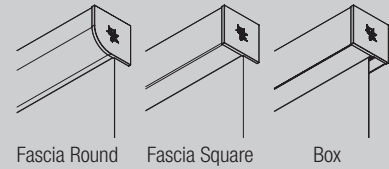

Roller Blind Fascia: Round or Square for systems 4910 / 4960											Small
Width	60cm	80cm	100cm	120cm	140cm	160cm	180cm	200cm	220cm	240cm	Price Cat
£	54.85	63.04	71.21	79.39	95.76	103.93	103.93	112.12	120.31	128.48	C

Roller Blind Fascia: Round or Square for systems 4910 / 4960 / 4930 / 4970																Large
Width	60cm	80cm	100cm	120cm	140cm	160cm	180cm	200cm	220cm	240cm	260cm	280cm	300cm	320cm	340cm	Price Cat
£	96.55	110.40	124.26	138.11	151.97	165.83	179.67	193.53	207.38	221.24	235.10	248.95	262.80	276.65	290.51	C

Roller Blind Box: For use with systems 4910 / 4960											Small
Width	60cm	80cm	100cm	120cm	140cm	160cm	180cm	200cm	220cm	240cm	Price Cat
£	62.30	72.98	83.64	94.32	104.99	115.65	126.33	136.99	147.66	158.26	C

Roller Blind Box: For use with systems 4910 / 4960 / 4930 / 4970																Large
Width	60cm	80cm	100cm	120cm	140cm	160cm	180cm	200cm	220cm	240cm	260cm	280cm	300cm	320cm	340cm	Price Cat
£	111.69	130.64	149.59	168.54	187.49	206.43	225.39	244.34	263.29	282.24	301.19	320.15	339.09	358.04	376.99	C

Side channels for systems 4960 / 4970											
Drop	50cm	100cm	150cm	200cm	250cm	300cm	350cm	400cm	450cm	500cm	Price Cat
£	24.63	49.27	73.90	98.53	123.17	147.80	172.43	197.07	221.70	246.33	C

### Additional Notes:

Cannot be used with side guides or with double systems, but multiple blinds with a single fascia cover possible (dependant on system limitations).

When using the small fascia or box fabric drops are restricted, please see technical pages for information.

When using Fascia/Box Small or Large with systems 4910/4960, bottom bar SG11442 is supplied as standard.

When using Fascia/Box Large with systems 4930/4970 the standard bottom bar supplied will be SG10993.



# Roller Blind Systems

## Max System Height for Fascia/Box Small

(There are no drop restrictions for Fascia/Box Large)

Roller Blind Fabrics		Standard System without Box/Fascia		Standard System with S Box/Fascia	
Collection 2022		Max Height		Max Height	
Fabric	Thickness MM	4910	4960	4910	4960
Atracor	0.54	300	400	260	240
Colorama Acoustic	0.40	300	400	300	340
Colorama Acoustic Multicolor	0.40	300	400	300	340
Colorama 1	0.33	300	400	300	400
Colorama 1 Alu	0.40	300	400	300	340
Colorama 1 Bioactive	0.33	300	400	300	400
Colorama 1 Eco	0.33	300	400	300	400
Colorama 1 Multicolour	0.45	300	400	300	300
Reflex	0.36	300	400	300	400
Aluscreen Futura	0.45	300	400	300	300
Alutex	0.43	300	400	300	310
Colorama 2	0.52	300	400	280	260
Colorama 2 Bioactive	0.55	300	400	260	240
Colorama 2 Eco	0.52	300	400	280	260
Colorama 2 Multicolour	0.55	300	400	260	240
Jumbotex	0.80	280	400	180	160
Multi Visio	0.40	300	400	300	340
Multiscreen 1%	0.55	300	400	260	240
Multiscreen 10%	0.47	300	400	300	290
Multiscreen 5%	0.55	300	400	260	240
Safescreen	0.20	300	400	300	400
Versascreen 1%	0.70	300	400	200	180
Versascreen 2 %	0.63	300	400	220	200
Versascreen 5%	0.55	300	400	260	240
Versascreen 10%	0.55	300	400	260	240
Element	0.30	300	400	300	400
Multi Shadow	0.35	300	400	300	400
Deep	0.45	300	400	300	300
Mercuro	0.38	300	400	300	360
Moon	0.45	300	400	300	300
Multicolour Dimout	0.80	280	400	180	160
Puma	0.38	300	400	300	360
Newlifescreeen	0.55	300	400	260	240
Newlifescreeen Alu	0.55	300	400	260	240
Basicscreen 1%	0.65	300	400	220	200
Basicscreen 5%	0.55	300	400	260	240
Basicscreen 10%	0.50	300	400	290	270
Nox	0.44	300	400	300	310
Triscreen 1%	0.64	300	400	220	200
Triscreen 3%	0.63	300	400	220	200
Triscreen 5%	0.61	300	400	220	200

Max. System Height
  Limitations in Height





# Dim-Out Blind Systems

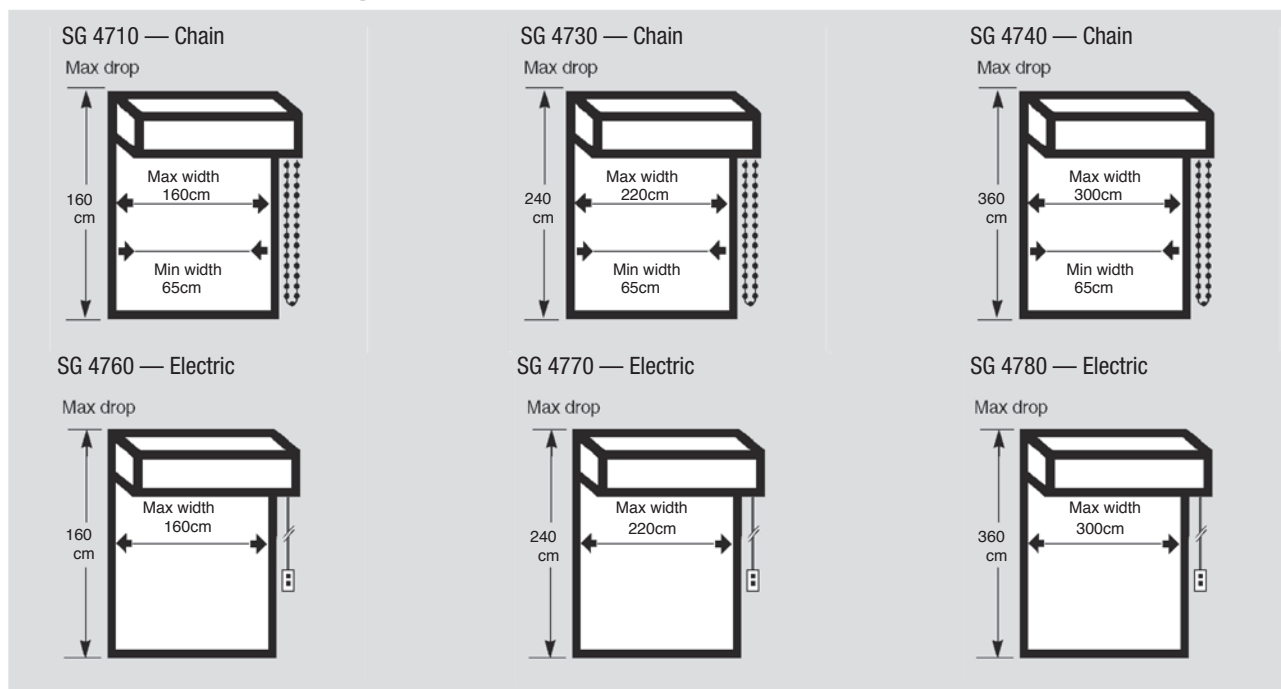

Price category C

The prices in the tables comprise the complete system made-to-measure, with fabric chosen, ready to install.

Colours: White or black available as standard.  
Other colours special orders - consult with Silent Gliss  
(Accessories available in white or black only)

If sizes lie between the measurements shown, the price for the next larger size will apply.

Note: Laminated customer own fabric not available.  
\*If welded, white not recommended as discolours.

## SG 4710 - Chain (Headbox size: 73mm)

### Price Group 1R

Puma

Width	65cm	80cm	100cm	120cm	140cm	160cm	Width
Drop (cm)							Drop (cm)
60	312.20	334.61	364.41	394.31	424.22	454.04	60
80	338.47	360.89	390.72	420.62	450.52	480.33	80
100	364.77	387.19	417.01	446.91	476.80	506.63	100
120	391.05	413.48	443.29	473.19	503.10	532.93	120
140	417.37	439.77	469.60	499.49	529.39	559.21	140
160	443.65	466.08	495.88	525.80	555.69	585.52	160

### Price Group 2R

Basic Screen 5%  
Mercurio  
Nox

Width	65cm	80cm	100cm	120cm	140cm	160cm	Width
Drop (cm)							Drop (cm)
60	419.85	442.23	472.14	501.97	531.85	561.74	60
80	459.63	482.03	511.88	541.75	571.59	601.48	80
100	499.34	521.76	551.65	581.49	611.39	641.22	100
120	539.13	561.54	591.37	621.27	651.09	680.99	120
140	578.87	601.27	631.17	661.00	690.90	720.72	140
160	618.58	640.97	670.88	700.71	730.60	760.52	160

### Price Group 3R

Moon

Width	65cm	80cm	100cm	120cm	140cm	160cm	Width
Drop (cm)							Drop (cm)
60	494.26	516.68	546.58	576.48	606.31	636.19	60
80	543.36	565.77	595.65	625.49	655.38	685.28	80
100	592.41	614.83	644.73	674.54	704.45	734.26	100
120	641.47	663.88	693.72	723.63	753.50	783.35	120
140	690.56	712.97	742.79	772.70	802.52	832.43	140
160	739.55	761.95	791.87	821.75	851.59	881.47	160

All prices shown exclude VAT







## Dim-Out Blind System SG 4760 - Electric (Headbox size: 73mm)

Price category C

### Price Group 1R - Puma

Width	65cm	80cm	100cm	120cm	140cm	160cm	Width
Drop cm							Drop cm
60	1020.68	1052.03	1093.81	1135.67	1177.53	1219.28	60
80	1057.47	1088.84	1130.61	1172.47	1214.32	1256.09	80
100	1094.31	1125.67	1167.41	1209.28	1251.13	1292.89	100
120	1131.12	1162.47	1204.25	1246.09	1287.94	1329.70	120
140	1167.93	1199.29	1241.06	1282.91	1324.76	1366.52	140
160	1204.74	1236.08	1277.85	1319.72	1361.56	1403.32	160

### Price Group 2R - Basic Screen 5%, Mercurio and Nox

Width	65cm	80cm	100cm	120cm	140cm	160cm	Width
Drop cm							Drop cm
60	1171.38	1202.76	1244.61	1286.37	1328.22	1370.06	60
80	1227.07	1258.43	1300.20	1342.07	1383.83	1425.68	80
100	1282.70	1314.06	1355.93	1397.69	1439.54	1481.32	100
120	1338.39	1369.68	1411.53	1453.40	1495.16	1537.02	120
140	1394.02	1425.40	1467.12	1509.01	1550.86	1592.61	140
160	1449.64	1480.99	1522.86	1564.61	1606.46	1648.32	160

### Price Group 3R - Moon

Width	65cm	80cm	100cm	120cm	140cm	160cm	Width
Drop cm							Drop cm
60	1275.53	1306.92	1348.77	1390.62	1432.38	1474.23	60
80	1344.23	1375.61	1417.47	1459.21	1501.06	1542.92	80
100	1412.93	1444.29	1486.15	1527.90	1569.75	1611.52	100
120	1481.61	1512.99	1554.72	1596.58	1638.43	1680.20	120
140	1550.30	1581.68	1623.44	1665.29	1707.04	1748.89	140
160	1618.99	1650.26	1692.13	1733.97	1775.74	1817.59	160

System Control Options – Radio control standard option is with System 9940, see page 28.

Series 40 motors –With integrated radio receiver for operation with SG wireless system 9940 – add on £254.88 per system, see page 28.

NOTE: 24v Series 40 Motors are not supplied with power supplies (transformers) as standard. They must be ordered separately, see page 28.

Series 50 SMART by Silent Gliss motors – for use with Silent Gliss Gateway and associated components – add on £254.88 per system, see page 28.

## Dim-Out Roller Blind SG 4770 - Electric (Headbox size: 90mm)

Price category C

### Price Group 1R - Puma

Width	65cm	80cm	100cm	120cm	140cm	160cm	180cm	200cm	220cm	Width
Drop cm										Drop cm
60	1032.08	1065.72	1110.53	1155.36	1200.18	1245.09	1488.81	1533.64	1578.45	60
80	1068.88	1102.53	1147.33	1192.17	1236.98	1281.91	1550.47	1595.29	1640.10	80
100	1105.68	1139.32	1184.14	1228.99	1273.81	1318.72	1612.09	1656.93	1701.76	100
120	1142.49	1176.13	1220.95	1265.78	1310.62	1355.53	1673.76	1718.60	1763.50	120
140	1179.30	1212.94	1257.76	1302.59	1347.44	1392.35	1735.40	1780.32	1825.15	140
160	1216.11	1249.75	1294.57	1339.41	1384.23	1429.14	1797.14	1841.98	1886.82	160
180	1252.92	1286.56	1331.38	1376.21	1421.04	1465.95	1858.80	1903.60	1948.45	180
200	1289.74	1323.37	1368.18	1413.02	1457.86	1502.75	1920.44	1965.25	2010.09	200
220	1326.54	1360.19	1405.00	1449.84	1494.67	1539.47	1982.09	2026.91	2071.82	220
240	1363.34	1396.99	1441.80	1486.63	1531.47	1576.30	2043.73	2088.65	2133.46	240

### Price Group 2R - Basic Screen 5%, Mercurio and Nox

Width	65cm	80cm	100cm	120cm	140cm	160cm	180cm	200cm	220cm	Width
Drop cm										Drop cm
60	1182.77	1216.41	1261.22	1306.16	1350.98	1395.79	1440.64	1546.71	1591.51	60
80	1238.48	1272.12	1316.95	1361.77	1406.57	1451.41	1496.32	1609.93	1654.84	80
100	1294.08	1327.73	1372.55	1417.35	1462.29	1507.12	1551.94	1673.27	1718.08	100
120	1349.78	1383.33	1428.26	1473.08	1517.90	1562.74	1607.55	1736.59	1781.43	120
140	1405.39	1439.04	1483.88	1528.70	1573.52	1618.46	1663.25	1799.82	1844.74	140
160	1461.02	1494.67	1539.47	1584.40	1629.24	1674.04	1718.86	1863.14	1907.97	160
180	1516.71	1550.36	1595.17	1640.03	1684.82	1729.65	1774.58	1926.48	1971.31	180
200	1572.35	1605.99	1650.81	1695.63	1740.56	1785.37	1830.21	1989.72	2034.63	200
220	1628.06	1661.59	1706.51	1751.35	1796.17	1840.96	1885.79	2053.05	2097.85	220
240	1683.66	1717.30	1762.12	1806.94	1851.74	1896.68	1941.51	2116.37	2161.17	240

### Price Group 3R - Moon

Width	65cm	80cm	100cm	120cm	140cm	160cm	180cm	200cm	220cm	Width
Drop cm										Drop cm
60	1287.01	1320.55	1365.48	1410.31	1455.13	1499.95	1544.78	1589.69	1634.54	60
80	1355.61	1389.27	1434.09	1479.01	1523.83	1568.67	1613.47	1658.30	1703.22	80
100	1424.29	1457.94	1502.75	1547.60	1592.51	1637.35	1682.17	1727.00	1771.81	100
120	1492.99	1526.64	1571.45	1616.29	1661.12	1706.04	1750.86	1795.67	1840.49	120
140	1561.67	1595.33	1640.16	1684.99	1729.80	1774.62	1819.55	1864.38	1909.19	140
160	1630.39	1663.90	1708.83	1753.67	1798.49	1843.32	1888.15	1933.06	1977.88	160
180	1698.97	1732.62	1777.44	1822.37	1867.18	1912.02	1956.85	2001.65	2046.59	180
200	1767.64	1801.29	1846.12	1890.96	1935.86	1980.71	2025.53	2070.36	2115.18	200
220	1836.34	1869.99	1914.81	1959.65	2004.47	2049.39	2094.22	2139.04	2183.85	220
240	1905.04	1938.68	1983.50	2028.34	2073.15	2117.99	2162.90	2207.74	2252.56	240

System Control Options – Radio control standard option is with System 9940, see page 28.

Series 40 motors –With integrated radio receiver for operation with SG wireless system 9940 – add on £254.88 per system, see page 28.

NOTE: 24v Series 40 Motors are not supplied with power supplies (transformers) as standard. They must be ordered separately, see page 28.

Series 50 SMART by Silent Gliss motors – for use with Silent Gliss Gateway and associated components – add on £254.88 per system, see page 28.

All prices shown exclude VAT



# Dim-Out Blind System SG 4780 - Electric (Headbox size: 110mm)

Price category C

## Price Group 1R - Puma

Width	65cm	80cm	100cm	120cm	140cm	160cm	180cm	200cm	220cm	240cm	260cm	280cm	300cm	Width
Drop cm														Drop cm
60	1193.07	1237.09	1295.75	1354.44	1413.21	1471.89	1729.46	1788.15	1846.81	1905.50	1964.27	2022.94	2081.64	60
80	1229.88	1273.91	1332.56	1391.25	1450.02	1508.70	1791.11	1849.79	1908.46	1967.23	2025.92	2084.59	2143.28	80
100	1266.68	1310.70	1369.40	1428.06	1486.83	1545.52	1852.76	1911.43	1970.19	2028.89	2087.56	2146.26	2204.91	100
120	1303.51	1347.51	1406.20	1464.87	1523.63	1582.34	1914.40	1973.18	2031.86	2090.53	2149.20	2207.91	2266.65	120
140	1340.32	1384.33	1443.00	1501.69	1560.46	1619.13	1976.16	2034.81	2093.50	2152.19	2210.85	2269.64	2328.32	140
160	1377.13	1421.14	1479.81	1538.49	1597.26	1655.94	2037.80	2096.46	2155.15	2213.82	2272.59	2331.28	2389.98	160
180	1413.92	1457.94	1516.62	1575.30	1633.96	1692.75	2099.43	2158.12	2216.80	2275.57	2334.27	2392.92	2451.61	180
200	1450.74	1494.75	1553.45	1612.09	1670.78	1729.58	2161.08	2219.76	2278.54	2337.21	2395.90	2454.58	2513.25	200
220	1487.56	1531.56	1590.25	1648.92	1707.59	1766.37	2222.74	2281.51	2340.20	2398.87	2457.54	2516.22	2574.99	220
240	1524.38	1568.38	1627.04	1685.73	1744.40	1803.17	2284.47	2343.16	2401.83	2460.51	2519.19	2577.97	2636.66	240
260	1561.17	1605.18	1663.85	1722.53	1781.21	1839.98	2346.13	2404.81	2463.49	2522.16	2580.94	2639.62	2698.28	260
280	1597.99	1642.01	1700.65	1759.33	1818.02	1876.79	2407.77	2466.44	2525.14	2583.91	2642.58	2701.25	2759.94	280
300	1634.79	1678.81	1737.48	1796.17	1854.82	1913.61	2469.44	2528.09	2586.88	2645.57	2704.22	2762.92	2821.58	300
320	1671.59	1715.60	1774.31	1833.00	1891.63	1950.43	2531.09	2589.74	2648.60	2707.20	2765.86	2824.60	2883.24	320
340	1708.40	1752.40	1811.13	1869.82	1928.44	1987.24	2592.76	2651.40	2710.26	2769.12	2827.50	2886.28	2944.89	340
360	1745.20	1789.21	1847.95	1906.64	1965.24	2024.05	2654.41	2713.27	2772.13	2831.00	2889.84	2948.63	3007.33	360

## Price Group 2R - Basic Screen 5% (up to 300cm), Mercurio and Nox (up to 260cm)

Width	65cm	80cm	100cm	120cm	140cm	160cm	180cm	200cm	220cm	240cm	260cm	280cm	300cm	Width
Drop cm														Drop cm
60	1410.14	1457.94	1521.66	1585.40	1649.19	1712.95	1776.66	1840.39	2031.57	2095.28	2159.00	2222.82	2286.56	60
80	1451.13	1498.90	1562.62	1626.44	1690.17	1753.90	1817.62	1881.36	2088.45	2152.19	2216.00	2279.73	2343.44	80
100	1492.10	1539.98	1603.70	1667.43	1731.13	1794.88	1858.68	1922.42	2145.35	2209.19	2272.91	2336.63	2400.33	100
120	1533.12	1580.95	1644.66	1708.40	1772.10	1835.93	1899.66	1963.38	2202.36	2266.06	2329.80	2393.52	2457.26	120
140	1574.12	1621.91	1685.63	1749.35	1813.17	1876.91	1940.62	2004.34	2259.24	2322.97	2386.70	2450.40	2514.25	140
160	1615.07	1662.88	1726.60	1790.41	1854.15	1917.88	1981.59	2045.32	2316.13	2379.87	2443.59	2507.42	2571.13	160
180	1656.04	1703.83	1767.64	1831.37	1895.12	1958.83	2022.56	2086.39	2373.05	2436.75	2500.58	2564.32	2628.03	180
200	1697.12	1744.89	1808.61	1872.33	1936.06	1999.81	2063.62	2127.36	2429.95	2493.75	2557.49	2621.22	2684.94	200
220	1738.07	1785.88	1849.58	1913.34	1977.13	2040.87	2104.59	2168.33	2486.94	2550.65	2614.38	2678.12	2741.83	220
240	1779.04	1826.83	1890.55	1954.37	2018.11	2081.83	2145.56	2209.27	2543.83	2607.56	2671.28	2735.01	2798.83	240
260	1820.01	1867.81	1931.60	1995.35	2059.06	2122.80	2186.51	2250.35	2600.71	2664.43	2728.18	2791.99	2855.74	260
280	1860.96	1908.85	1972.59	2036.32	2100.05	2163.75	2227.59	2291.31	2657.62	2721.34	2785.17	2848.89	2912.59	280
300	1902.04	1949.82	2013.56	2077.29	2141.00	2204.84	2268.54	2332.28	2714.51	2778.33	2842.07	2905.78	2969.52	300
320	1943.11	1990.78	2054.52	2118.26	2181.95	2245.92	2309.50	2373.24	2771.40	2835.34	2899.25	2963.15	3027.05	320
340	1984.18	2031.77	2095.47	2159.22	2222.92	2287.00	2350.46	2414.21	2828.30	2892.33	2956.34	3020.34	3084.34	340
360	2025.26	2072.73	2136.43	2200.19	2263.87	2328.09	2391.41	2455.19	2885.19	2949.33	3013.44	3077.47	3141.52	360

## Price Group 3R - Moon

Width	65cm	80cm	100cm	120cm	140cm	160cm	180cm	200cm	220cm	240cm	260cm	280cm	300cm	Width
Drop cm														Drop cm
60	1447.94	1492.07	1550.72	1609.40	1668.07	1726.74	1785.53	1844.22	1902.87	1927.66				60
80	1516.62	1560.65	1619.43	1678.10	1736.76	1795.45	1854.12	1912.91	1971.56	1996.34				80
100	1585.32	1629.33	1687.99	1746.78	1805.46	1864.15	1922.80	1981.49	2040.29	2065.11				100
120	1654.00	1698.00	1756.71	1815.36	1874.14	1932.83	1991.51	2050.18	2108.84	2133.77				120
140	1722.70	1766.70	1825.41	1884.06	1942.74	2001.53	2060.21	2118.86	2177.54	2202.44				140
160	1791.29	1835.42	1894.08	1952.75	2011.44	2070.09	2128.88	2187.58	2246.22	2271.11				160
180	1859.98	1904.00	1962.77	2021.46	2080.12	2138.82	2197.48	2256.28	2314.94	2339.79				180
200	1928.69	1972.69	2031.37	2090.13	2148.82	2207.50	2266.18	2324.84	2383.64	2408.47				200
220	1997.37	2041.36	2100.06	2158.73	2217.51	2276.18	2334.87	2393.53	2452.20	2477.14				220
240	2066.06	2110.08	2168.75	2227.44	2286.10	2344.88	2403.57	2462.23	2520.93	2545.81				240
260	2134.66	2178.77	2237.43	2296.12	2354.79	2413.45	2472.24	2530.92	2589.61	2614.49				260
280	2203.33	2247.35	2306.13	2364.82	2423.48	2482.18	2540.85	2599.63	2658.31	2683.15				280
300	2272.04	2316.04	2374.74	2433.49	2492.19	2550.86	2609.53	2668.20	2726.99	2751.83				300
320	2340.74	2384.72	2443.34	2502.17	2560.88	2619.55	2678.20	2736.79	2795.68	2820.50				320
340	2409.44	2453.42	2511.94	2570.84	2629.58	2688.26	2746.87	2805.37	2864.36	2889.18				340
360	2478.14	2522.10	2580.55	2639.51	2698.27	2756.92	2815.55	2873.96	2933.05	2957.85				360

System Control Options – Radio control standard option is with System 9940, see page 28.

Series 40 motors –With integrated radio receiver for operation with SG wireless system 9940 – add on £254.88 per system, see page 28.

NOTE: 24v Series 40 Motors are not supplied with power supplies (transformers) as standard. They must be ordered separately, see page 28.

Series 50 SMART by Silent Gliss motors – for use with Silent Gliss Gateway and associated components – add on £254.88 per system, see page 28.

All prices shown exclude VAT



# Venetian Blind Systems

## Venetian Blind Slat Information

### Aluminium Slats

#### Price Group 1

Slat Reference	Slat Width (mm)	Slat Description
603	16	Natural Alu
612	16	Off White
615	16	White

Slat Reference	Slat Width (mm)	Slat Description
648	16	Light Grey
650	16	Magnolia
706	25	Natural Alu
716	25	Off White

Slat Reference	Slat Width (mm)	Slat Description
720	25	White
758	25	Light Grey

Slat Reference	Slat Width (mm)	Slat Description
761	25	Magnolia

#### Price Group 2

Slat Reference	Slat Width (mm)	Slat Description
602	16	TRP Natural Silver
604	16	Bright Silver
609	16	Natural Silver
610	16	Natural Silver Matt
611	16	Light Ash
613	16	Clear White
614	16	Pearl China White
617	16	Grey Flannel

Slat Reference	Slat Width (mm)	Slat Description
618	16	Metal Grey
619	16	Gloss Black
620	16	Black
651	16	Magnolia
704	25	TRP Natural Silver
705	25	Alu Perforated
707	25	Bright Silver
712	25	Natural Silver

Slat Reference	Slat Width (mm)	Slat Description
713	25	Natural Silver Matt
714	25	Light Ash
715	25	White Perforated
718	25	Clear White
719	25	Pearl China White
724	25	Grey Flannel
725	25	Metal Grey
726	25	Gloss Black
729	25	Black

Slat Reference	Slat Width (mm)	Slat Description
759	25	Light Grey
760	25	Magnolia Perforated
762	25	Magnolia
773	25	Garnet Red

#### Price Group 3

Slat Reference	Slat Width (mm)	Slat Description
601	16	Polished Alu
605	16	Bright Gold
607	16	Bright Bronze
608	16	Aluminium Gris
616	16	Light Grey
622	16	Indigo
635	16	Hunter Green
652	16	Fawn
654	16	US Beige
656	16	Dark Beige
702	25	Alu Perforated
703	25	Polished Alu
708	25	Bright Gold
709	25	Caribou
710	25	Bright Bronze
711	25	Aluminium Gris
722	25	Grey Perforated
723	25	Light Grey
727	25	Black Perforated
728	25	Black
731	25	Indigo
732	25	Admiral

Slat Reference	Slat Width (mm)	Slat Description
733	25	Turkey Blue
734	25	Mount Baker
735	25	Morning Glory
736	25	Universe Blue
738	25	Fishing Blue
739	25	Greek Holiday
745	25	Hunter Green
747	25	Green Aspen
748	25	Weeping Green
749	25	Grass Snake
751	25	Aztec
752	25	Saffron
754	25	Daffodil
756	25	Light Banana
757	25	Beaverwood
764	25	Fawn
765	25	Spun Gold
766	25	US Beige
767	25	Mud Pie
768	25	Dark Beige
769	25	Diamond Mine
777	25	Woodgrain Abbey



# Venetian Blind Systems

## SG 8110 (16mm)

Mono control Venetian Blind System.  
Slats 16mm.

Maximum System Width: 2.5m

Minimum System Width: 28cm

Maximum System Drop: 2.5m

Maximum Surface Area: 5m<sup>2</sup>

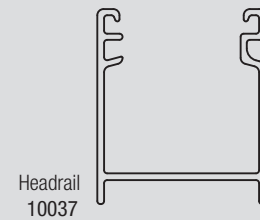
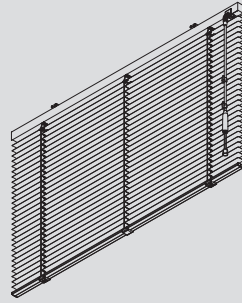

The prices in the tables below comprise the complete system made-to-measure with 16mm slats ready to hang. If sizes lie between the measurements shown, the price for the next size larger will apply. Clear control wands as standard. The following wand sizes are available 225mm, 385mm, 585mm, 785mm, 985mm, 1185mm, 1385mm, 1585mm and 1800mm. For side guided version please add 20% to prices below.

### Price Group 1

Price Category C

Width Drop cm	60cm	80cm	100cm	120cm	140cm	160cm	180cm	200cm	220cm	240cm	250cm	Width Drop cm
100	274.34	304.27	334.20	364.13	394.06	423.99	453.92	483.85	513.78	543.71	558.68	100
120	280.32	312.24	344.16	376.08	408.00	439.92	471.84	503.76	535.68	567.60	583.56	120
140	286.64	320.56	354.48	388.40	422.32	456.24	490.16	524.08	558.00	591.92	608.88	140
160	292.63	328.88	365.13	401.38	437.63	473.88	510.13	546.38	582.63	618.88	637.01	160
180	298.61	336.85	375.09	413.33	451.57	489.81	528.05	566.29	604.53	642.77	661.89	180
200	304.93	345.16	385.39	425.62	465.85	506.08	546.31	586.54	626.77	667.00	687.12	200
220	310.92	353.12	395.32	437.52	479.72	521.92	564.12	606.32	648.52			220
240	316.90	361.13	405.36	449.59	493.82	538.05	582.28	626.51				240
250	320.23	365.45	410.67	455.89	501.11	546.33	591.55	636.77				250

### Price Group 2

Price Category C

Width Drop cm	60cm	80cm	100cm	120cm	140cm	160cm	180cm	200cm	220cm	240cm	250cm	Width Drop cm
100	318.23	353.15	388.07	422.99	457.91	492.83	527.75	562.67	597.59	632.51	649.97	100
120	325.21	362.45	399.69	436.93	474.17	511.41	548.65	585.89	623.13	660.37	678.99	120
140	332.20	371.77	411.34	450.91	490.48	530.05	569.62	609.19	648.76	688.33	708.11	140
160	339.51	381.40	423.29	465.18	507.07	548.96	590.85	632.74	674.63	716.52	737.46	160
180	346.50	390.73	434.96	479.19	523.42	567.65	611.88	656.11	700.34	744.57	766.68	180
200	353.48	400.03	446.58	493.13	539.68	586.23	632.78	679.33	725.88	772.43	795.70	200
220	360.80	409.68	458.56	507.44	556.32	605.20	654.08	702.96	751.84			220
240	367.78	418.98	470.18	521.38	572.58	623.78	674.98	726.18				240
250	371.44	423.98	476.52	529.06	581.60	634.14	686.68	739.22				250

### Price Group 3

Price Category C

Width Drop cm	60cm	80cm	100cm	120cm	140cm	160cm	180cm	200cm	220cm	240cm	250cm	Width Drop cm
100	389.39	431.95	474.51	517.07	559.63	602.19	644.75	687.31	729.87	772.43	793.71	100
120	398.04	443.60	489.16	534.72	580.28	625.84	671.40	716.96	762.52	808.08	830.86	120
140	406.68	454.90	503.12	551.34	599.56	647.78	696.00	744.22	792.44	840.66	864.77	140
160	415.33	466.53	517.73	568.93	620.13	671.33	722.53	773.73	824.93	876.13	901.73	160
180	423.98	478.18	532.38	586.58	640.78	694.98	749.18	803.38	857.58	911.78	938.88	180
200	432.95	489.81	546.67	603.53	660.39	717.25	774.11	830.97	887.83	944.69	973.12	200
220	441.60	501.45	561.30	621.15	681.00	740.85	800.70	860.55	920.40			220
240	450.25	513.10	575.95	638.80	701.65	764.50	827.35	890.20				240
250	454.57	518.75	582.93	647.11	711.29	775.47	839.65	903.83				250

All prices shown exclude VAT



# Venetian Blind Systems

## SG 8110PC (25mm)

Mono control Venetian Blind System.  
 Slats 25mm.  
 Maximum System Width: 3m  
 Minimum System Width: 28cm  
 Maximum System Drop: 3m  
 Maximum Surface Area: 7m<sup>2</sup>

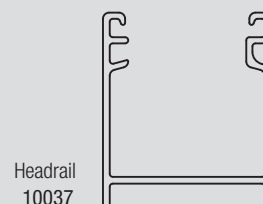
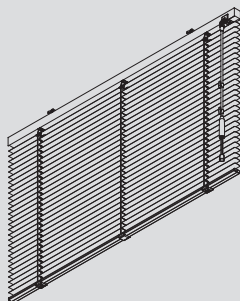

The prices in the tables below comprise the complete system made-to-measure with 25mm slats ready to hang. If sizes lie between the measurements shown, the price for the next size larger will apply. Clear control wands as standard. The following wand sizes are available 225mm, 385mm, 585mm, 785mm, 985mm, 1185mm, 1385mm, 1585mm and 1800mm. For side guided version please add 20% to prices below.

### Price Group 1

Price Category C

Width Drop cm	60cm	80cm	100cm	120cm	140cm	160cm	180cm	200cm	220cm	240cm	260cm	280cm	300cm	Width Drop cm
100	274.35	302.51	330.66	358.82	386.97	415.13	443.29	471.44	499.60	527.75	555.91	584.07	612.22	100
120	280.27	310.41	340.55	370.68	400.82	430.96	461.09	491.23	521.37	551.51	581.64	611.78	641.92	120
140	286.19	318.30	350.41	382.52	414.63	446.74	478.84	510.95	543.06	575.17	607.28	639.39	671.49	140
160	292.45	326.53	360.61	394.69	428.77	462.85	496.92	531.00	565.08	599.16	633.24	667.32	701.40	160
180	298.37	334.42	370.47	406.52	442.57	478.62	514.67	550.72	586.78	622.83	658.88	694.93	730.98	180
200	304.29	342.32	380.35	418.39	456.42	494.45	532.48	570.51	608.55	646.58	684.61	722.64	760.67	200
220	310.54	350.55	390.55	430.55	470.56	510.56	550.56	590.57	630.57	670.57	710.58	750.58	790.58	220
240	316.47	358.44	400.41	442.39	484.36	526.34	568.31	610.29	652.26	694.24	736.21	778.18		240
260	322.39	366.33	410.28	454.22	498.17	542.12	586.06	630.01	673.95	717.90	761.84			260
280	328.64	374.57	420.50	466.42	512.35	558.28	604.20	650.13	696.06	741.98				280
300	334.56	382.79	431.02	479.25	527.48	575.70	623.93	672.16	720.39					300

### Price Group 2

Price Category C

Width Drop cm	60cm	80cm	100cm	120cm	140cm	160cm	180cm	200cm	220cm	240cm	260cm	280cm	300cm	Width Drop cm
100	333.54	367.36	401.17	434.99	468.80	502.62	536.44	570.25	604.07	637.88	671.70	705.52	739.33	100
120	340.79	376.91	413.03	449.14	485.26	521.38	557.50	593.61	629.73	665.85	701.96	738.08	774.20	120
140	348.04	386.47	424.90	463.33	501.76	540.19	578.61	617.04	655.47	693.90	732.33	770.76	809.18	140
160	354.96	396.02	437.08	478.14	519.20	560.26	601.32	642.38	683.44	724.50	765.56	806.62	847.68	160
180	362.21	405.59	448.96	492.33	535.70	579.07	622.44	665.81	709.18	752.55	795.92	839.29	882.66	180
200	369.13	414.81	460.48	506.15	551.82	597.49	643.17	688.84	734.51	780.18	825.85	871.53	917.20	200
220	376.39	424.37	472.35	520.33	568.32	616.30	664.28	712.27	760.25	808.23	856.22	904.20	952.18	220
240	383.64	434.26	484.89	535.51	586.13	636.76	687.38	738.01	788.63	839.26	889.88	940.51		240
260	390.56	443.48	496.41	549.33	602.26	655.18	708.11	761.04	813.96	866.89	919.81			260
280	397.81	453.04	508.28	563.52	618.76	673.99	729.23	784.47	839.70	894.94				280
300	405.06	462.60	520.14	577.67	635.21	692.75	750.29	807.83	865.36					300

### Price Group 3 – 25mm slat size

Price Category C

Width Drop cm	60cm	80cm	100cm	120cm	140cm	160cm	180cm	200cm	220cm	240cm	260cm	280cm	300cm	Width Drop cm
100	435.96	479.75	523.53	567.32	611.10	654.89	698.68	742.46	786.25	830.03	873.82	917.61	961.39	100
120	445.21	491.96	538.72	585.48	632.24	678.99	725.75	772.51	819.26	866.02	912.78	959.54	1006.29	120
140	454.12	504.18	554.24	604.30	654.35	704.41	754.47	804.53	854.59	904.65	954.70	1004.76	1054.82	140
160	463.37	516.40	569.43	622.46	675.49	728.52	781.55	834.57	887.60	940.63	993.66	1046.69	1099.72	160
180	472.28	528.28	584.28	640.28	696.29	752.29	808.29	864.29	920.29	976.29	1032.29	1088.29	1144.29	180
200	481.20	540.18	599.16	658.14	717.12	776.11	835.09	894.07	953.05	1012.03	1071.02	1130.00	1188.98	200
220	490.44	552.40	614.35	676.30	738.26	800.21	862.16	924.12	986.07	1048.02	1109.98	1171.93	1233.88	220
240	499.36	564.28	629.21	694.13	759.06	823.98	888.90	953.83	1018.75	1083.68	1148.60	1213.53		240
260	508.60	576.50	644.40	712.29	780.19	848.08	915.98	983.87	1051.77	1119.66	1187.56			260
280	517.52	588.72	659.91	731.11	802.31	873.50	944.70	1015.90	1087.09	1158.29				280
300	526.77	600.93	675.10	749.27	823.44	897.61	971.77	1045.94	1120.11					300

All prices shown exclude VAT





# Venetian Blind Systems

## SG 8250 (16mm)

Electrically operated Venetian Blind System.  
System with 24v motor 8060.

Maximum System Width: 300cm  
Minimum System Width: 65cm\*  
Maximum System Drop: 340cm  
Maximum Surface Area: 5m<sup>2</sup>

\* Please refer to Catalogue pages

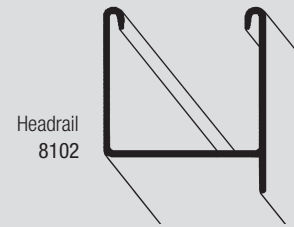
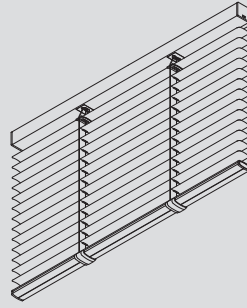

The prices in the tables below and on the following page comprise the complete system made-to-measure with 16mm slats ready to hang with universal snap bracket 8201. If sizes lie between the measurements shown, the price for the next size larger will apply. For multicoloured blinds add 20% to prices below for each colour. For side-guided/sloping version add 20% to prices below.

### Price Group 1

Price Category C

Width Drop cm	80cm	100cm	120cm	140cm	160cm	180cm	200cm	220cm	240cm	260cm	280cm	300cm	Width Drop cm
100	842.63	886.16	929.66	973.24	1016.74	1060.29	1103.88	1147.34	1190.91	1234.42	1277.94	1321.50	100
120	851.92	897.45	943.02	988.61	1034.17	1079.75	1125.31	1170.81	1216.44	1261.96	1307.53	1353.11	120
140	861.23	908.76	956.43	1003.97	1051.58	1099.13	1146.74	1194.39	1241.96	1289.52	1337.13	1384.71	140
160	870.57	920.19	969.73	1019.40	1069.04	1118.66	1168.23	1217.86	1267.47	1317.10	1366.72	1416.31	160
180	879.83	931.51	983.14	1034.81	1086.45	1138.06	1189.71	1241.38	1293.04	1344.65			180
200	889.16	942.84	996.50	1050.20	1103.89	1157.51	1211.19	1264.89	1318.55				200
220	898.45	954.16	1009.90	1065.56	1121.29	1176.96	1232.65	1288.35					220
240	907.80	965.55	1023.24	1080.93	1138.64	1196.45	1254.19						240
260	917.10	976.85	1036.60	1096.36	1156.11	1215.88							260
280	926.41	988.18	1049.98	1111.73	1173.54								280
300	935.72	999.54	1063.33	1127.14	1191.00								300
320	944.99	1010.87	1076.68	1142.53									320
340	954.36	1022.17	1090.04	1157.97									340

### Price Group 2

Price Category C

Width Drop cm	80cm	100cm	120cm	140cm	160cm	180cm	200cm	220cm	240cm	260cm	280cm	300cm	Width Drop cm
100	858.84	906.49	954.02	1001.64	1049.19	1096.76	1144.40	1191.96	1239.55	1287.13	1334.70	1382.36	100
120	869.77	919.79	969.78	1019.85	1069.88	1119.88	1169.88	1219.88	1269.95	1319.97	1369.97	1420.03	120
140	880.71	933.17	985.59	1038.06	1090.48	1142.93	1195.45	1247.93	1300.40	1352.78	1405.25	1457.71	140
160	891.62	946.52	1001.38	1056.31	1111.16	1166.06	1220.97	1275.85	1330.74	1385.64	1440.50	1495.40	160
180	902.54	959.90	1017.23	1074.56	1131.86	1189.16	1246.49	1303.79	1361.17	1418.45			180
200	913.51	973.27	1033.02	1092.75	1152.51	1212.26	1272.00	1331.76	1391.55				200
220	924.44	986.63	1048.79	1111.03	1173.16	1235.37	1297.55	1359.79					220
240	935.36	999.98	1064.61	1129.22	1193.84	1258.43	1323.10						240
260	946.32	1013.36	1080.37	1147.50	1214.50	1281.58							260
280	957.26	1026.76	1096.28	1165.71	1235.19								280
300	968.17	1040.07	1112.03	1183.90	1255.86								300
320	979.10	1053.48	1127.77	1202.13									320
340	990.03	1066.83	1143.59	1220.41									340

### Price Group 3

Price Category C

Width Drop cm	80cm	100cm	120cm	140cm	160cm	180cm	200cm	220cm	240cm	260cm	280cm	300cm	Width Drop cm
100	1012.22	1052.12	1092.02	1131.92	1171.82	1211.72	1251.62	1291.52	1331.42	1371.32	1411.22	1451.12	100
120	1023.53	1066.42	1109.31	1152.20	1195.09	1237.98	1280.87	1323.76	1366.65	1409.54	1452.43	1495.32	120
140	1035.17	1080.72	1126.27	1171.82	1217.37	1262.92	1308.47	1354.02	1399.57	1445.12	1490.67	1536.22	140
160	1046.47	1095.01	1143.55	1192.09	1240.63	1289.17	1337.71	1386.25	1434.79	1483.33	1531.87	1580.41	160
180	1058.11	1109.65	1161.19	1212.73	1264.27	1315.81	1367.35	1418.89	1470.43	1521.97			180
200	1069.42	1123.62	1177.82	1232.02	1286.22	1340.42	1394.62	1448.82	1503.02				200
220	1081.06	1138.25	1195.44	1252.63	1309.82	1367.01	1424.20	1481.39					220
240	1092.36	1152.54	1212.72	1272.90	1333.08	1393.26	1453.44						240
260	1104.00	1166.84	1229.68	1292.52	1355.36	1418.20							260
280	1115.31	1181.15	1246.99	1312.83	1378.67								280
300	1126.94	1195.44	1263.94	1332.44	1400.94								300
320	1138.25	1209.74	1281.23	1352.72									320
340	1149.89	1224.37	1298.85	1373.33									340

Supplied with standard 0928 rocker switch. Programmable rocker switch (0937) available as an optional accessory.

All prices shown exclude VAT



# Venetian Blind Systems

## SG 8250 (25mm)

Electrically operated Venetian Blind System.  
 System with 24v motor 8060.  
 Maximum System Width: 300cm  
 Minimum System Width: 65cm\*  
 Maximum System Drop: 340cm  
 Maximum Surface Area: 5m<sup>2</sup>  
 \* Please refer to Catalogue pages

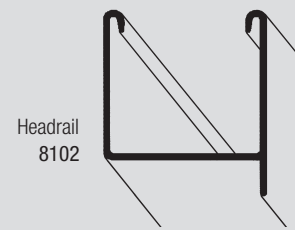
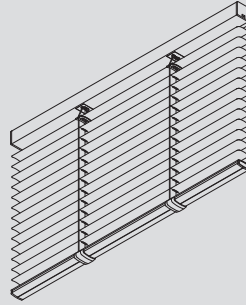

The prices in the tables below and on the following page comprise the complete system made-to-measure with 25mm slats ready to hang with universal snap bracket 8201. If sizes lie between the measurements shown, the price for the next size larger will apply. For multicoloured blinds add 20% to prices below for each colour. For side-guided/sloping version add 20% to prices below.

### Price Group 1

Price Category C

Width ▶ Drop ▼ cm	80cm	100cm	120cm	140cm	160cm	180cm	200cm	220cm	240cm	260cm	280cm	300cm	◀ Width ▼ Drop cm
100	822.90	862.29	901.67	941.00	980.41	1019.76	1059.12	1098.51	1137.83	1177.24	1216.54	1256.01	100
120	829.97	870.93	911.74	952.82	993.74	1034.72	1075.63	1116.61	1157.51	1198.46	1239.43	1280.38	120
140	837.06	879.55	922.06	964.58	1007.10	1049.63	1092.15	1134.70	1177.21	1219.73	1262.28	1304.74	140
160	844.07	888.20	932.28	976.42	1020.49	1064.58	1108.66	1152.76	1196.89	1240.96	1285.06	1329.18	160
180	851.16	896.79	942.47	988.18	1033.87	1079.56	1125.20	1170.82	1216.52	1262.23			180
200	858.20	905.48	952.77	999.97	1047.25	1094.48	1141.66	1188.97	1236.21				200
220	865.27	914.13	962.95	1011.76	1060.60	1109.42	1158.22	1207.07					220
240	872.28	922.73	973.16	1023.58	1073.96	1124.38	1174.73						240
260	879.36	931.39	983.36	1035.34	1087.33	1139.32							260
280	886.42	940.06	993.57	1047.15	1100.69								280
300	893.49	948.65	1003.81	1058.96	1114.07								300
320	900.59	957.31	1013.99	1070.72									320
340	907.58	965.92	1024.19	1082.54									340

### Price Group 2

Price Category C

Width ▶ Drop ▼ cm	80cm	100cm	120cm	140cm	160cm	180cm	200cm	220cm	240cm	260cm	280cm	300cm	◀ Width ▼ Drop cm
100	857.60	900.16	942.72	985.28	1027.84	1070.40	1112.96	1155.52	1198.08	1240.64	1283.20	1325.76	100
120	865.91	910.33	954.75	999.17	1043.59	1088.01	1132.43	1176.85	1221.27	1265.69	1310.11	1354.53	120
140	873.89	920.26	966.63	1013.00	1059.37	1105.74	1152.11	1198.48	1244.85	1291.22	1337.59	1383.96	140
160	882.20	930.44	978.68	1026.92	1075.16	1123.40	1171.64	1219.88	1268.12	1316.36	1364.60	1412.84	160
180	890.18	940.34	990.50	1040.66	1090.82	1140.98	1191.14	1241.30	1291.46	1341.62			180
200	898.16	951.41	1004.66	1057.91	1111.16	1164.41	1217.66	1270.91	1324.16				200
220	906.48	960.39	1014.30	1068.21	1122.12	1176.03	1229.94	1283.85					220
240	914.46	970.27	1026.08	1081.89	1137.70	1193.51	1249.32						240
260	922.77	980.46	1038.15	1095.84	1153.53	1211.22							260
280	930.75	990.36	1049.97	1109.58	1169.19								280
300	939.07	1000.54	1062.01	1123.48	1184.95								300
320	947.05	1010.43	1073.81	1137.19									320
340	955.03	1020.29	1085.55	1150.81									340

### Price Group 3

Price Category C

Width ▶ Drop ▼ cm	80cm	100cm	120cm	140cm	160cm	180cm	200cm	220cm	240cm	260cm	280cm	300cm	◀ Width ▼ Drop cm
100	1124.95	1163.19	1201.43	1239.67	1277.91	1316.15	1354.39	1392.63	1430.87	1469.11	1507.35	1545.59	100
120	1135.59	1176.49	1217.39	1258.29	1299.19	1340.09	1380.99	1421.89	1462.79	1503.69	1544.59	1585.49	120
140	1146.23	1189.79	1233.35	1276.91	1320.47	1364.03	1407.59	1451.15	1494.71	1538.27	1581.83	1625.39	140
160	1156.87	1203.09	1249.31	1295.53	1341.75	1387.97	1434.19	1480.41	1526.63	1572.85	1619.07	1665.29	160
180	1167.51	1216.39	1265.27	1314.15	1363.03	1411.91	1460.79	1509.67	1558.55	1607.43			180
200	1178.15	1229.69	1281.23	1332.77	1384.31	1435.85	1487.39	1538.93	1590.47				200
220	1188.80	1243.00	1297.20	1351.40	1405.60	1459.80	1514.00	1568.20					220
240	1199.44	1256.30	1313.16	1370.02	1426.88	1483.74	1540.60						240
260	1210.08	1269.60	1329.12	1388.64	1448.16	1507.68							260
280	1220.72	1282.90	1345.08	1407.26	1469.44								280
300	1231.36	1296.20	1361.04	1425.88	1490.72								300
320	1242.00	1309.50	1377.00	1444.50									320
340	1252.64	1322.80	1392.96	1463.12									340

Supplied with standard 0928 rocker switch. Programmable rocker switch (0937) available as an optional accessory.

All prices shown exclude VAT



# Venetian Blind Systems

## SG 8300 (16mm)

Mono control Venetian Blind System.

Slats 16mm.

Maximum System Width: 3m

Minimum System Width: 50cm

Maximum System Drop: 3m

Maximum Surface Area: 4.5m<sup>2</sup>

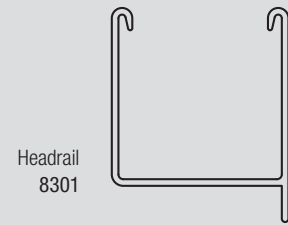
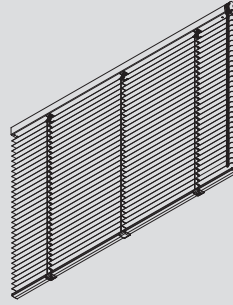

The prices in the tables below comprise the complete system made-to-measure with 16mm slats ready to hang. If sizes lie between the measurements shown, the price for the next size larger will apply. For side-guide or sloping add 20%.

### Price Group 1

Price Category C

Width ► Drop ▼ cm	60cm	80cm	100cm	120cm	140cm	160cm	180cm	200cm	220cm	240cm	260cm	280cm	300cm	Width ► Drop ▼ cm
100	301.94	334.53	367.12	399.71	432.30	464.89	497.48	530.07	562.66	595.25	627.84	660.43	693.02	100
120	308.92	343.50	378.08	412.66	447.24	481.82	516.40	550.98	585.56	620.14	654.72	689.30	723.88	120
140	316.24	352.81	389.38	425.95	462.52	499.09	535.66	572.23	608.80	645.37	681.94	718.51	755.08	140
160	323.22	361.79	400.36	438.93	477.50	516.07	554.64	593.21	631.78	670.35	708.92	747.49	786.06	160
180	330.53	371.09	411.65	452.21	492.77	533.33	573.89	614.45	655.01	695.57				180
200	337.85	380.41	422.97	465.53	508.09	550.65	593.21	635.77	678.33					200
220	344.83	389.39	433.95	478.51	523.07	567.63	612.19	656.75						220
240	352.15	399.03	445.91	492.79	539.67	586.55	633.43							240
260	359.47	408.35	457.23	506.11	554.99	603.87								260
280	366.45	417.32	468.19	519.06	569.93	620.80								280
300	373.76	426.63	479.50	532.37	585.24									300

### Price Group 2

Price Category C

Width ► Drop ▼ cm	60cm	80cm	100cm	120cm	140cm	160cm	180cm	200cm	220cm	240cm	260cm	280cm	300cm	Width ► Drop ▼ cm
100	350.15	387.72	425.29	462.86	500.43	538.00	575.57	613.14	650.71	688.28	725.85	763.42	800.99	100
120	358.47	398.70	438.93	479.16	519.39	559.62	599.85	640.08	680.31	720.54	760.77	801.00	841.23	120
140	366.78	409.34	451.90	494.46	537.02	579.58	622.14	664.70	707.26	749.82	792.38	834.94	877.50	140
160	375.09	419.98	464.87	509.76	554.65	599.54	644.43	689.32	734.21	779.10	823.99	868.88	913.77	160
180	383.41	430.63	477.85	525.07	572.29	619.51	666.73	713.95	761.17	808.39				180
200	391.72	441.27	490.82	540.37	589.92	639.47	689.02	738.57	788.12					200
220	400.03	451.90	503.77	555.64	607.51	659.38	711.25	763.12						220
240	408.35	462.55	516.75	570.95	625.15	679.35	733.55							240
260	416.66	473.19	529.72	586.25	642.78	699.31								260
280	425.31	484.16	543.01	601.86	660.71	719.56								280
300	433.62	494.81	556.00	617.19	678.38									300

### Price Group 3

Price Category C

Width ► Drop ▼ cm	60cm	80cm	100cm	120cm	140cm	160cm	180cm	200cm	220cm	240cm	260cm	280cm	300cm	Width ► Drop ▼ cm
100	428.30	474.52	520.74	566.96	613.18	659.40	705.62	751.84	798.06	844.28	890.50	936.72	982.94	100
120	438.61	487.82	537.03	586.24	635.45	684.66	733.87	783.08	832.29	881.50	930.71	979.92	1029.13	120
140	448.92	500.79	552.66	604.53	656.40	708.27	760.14	812.01	863.88	915.75	967.62	1019.49	1071.36	140
160	459.22	514.08	568.94	623.80	678.66	733.52	788.38	843.24	898.10	952.96	1007.82	1062.68	1117.54	160
180	469.20	527.06	584.92	642.78	700.64	758.50	816.36	874.22	932.08	989.94				180
200	479.51	540.03	600.55	661.07	721.59	782.11	842.63	903.15	963.67					200
220	489.82	553.33	616.84	680.35	743.86	807.37	870.88	934.39						220
240	500.13	566.63	633.13	699.63	766.13	832.63	899.13							240
260	510.10	579.26	648.42	717.58	786.74	855.90								260
280	520.41	592.57	664.73	736.89	809.05	881.21								280
300	530.72	605.87	681.02	756.17	831.32									300

Child safety device (10482) – add on £12.48.

All prices shown exclude VAT



# Venetian Blind Systems

## SG 8300 (25mm)

Mono control Venetian Blind System.  
 Slats 25mm.  
 Maximum System Width: 3m  
 Minimum System Width: 50cm  
 Maximum System Drop: 3m  
 Maximum Surface Area: 4.5m<sup>2</sup>

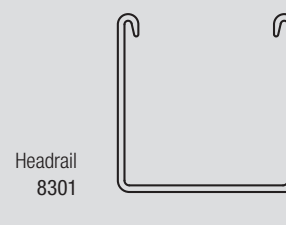
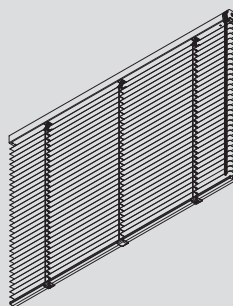

The prices in the tables below comprise the complete system made-to-measure with 25mm slats ready to hang. If sizes lie between the measurements shown, the price for the next size larger will apply. For side-guide or sloping add 20%.

### Price Group 1

Price Category C

Width ► Drop ▼ cm	60cm	80cm	100cm	120cm	140cm	160cm	180cm	200cm	220cm	240cm	260cm	280cm	300cm	◀ Width ▼ Drop cm
100	294.95	323.54	352.13	380.72	409.31	437.90	466.49	495.08	523.67	552.26	580.85	609.44	638.03	100
120	300.94	331.20	361.46	391.72	421.98	452.24	482.50	512.76	543.02	573.28	603.54	633.80	664.06	120
140	307.26	339.18	371.10	403.02	434.94	466.86	498.78	530.70	562.62	594.54	626.46	658.38	690.30	140
160	313.24	346.82	380.40	413.98	447.56	481.14	514.72	548.30	581.88	615.46	649.04	682.62	716.20	160
180	319.56	354.81	390.06	425.31	460.56	495.81	531.06	566.31	601.56	636.81				180
200	325.88	362.79	399.70	436.61	473.52	510.43	547.34	584.25	621.16					200
220	331.87	370.44	409.01	447.58	486.15	524.72	563.29	601.86						220
240	338.18	378.42	418.66	458.90	499.14	539.38	579.62							240
260	344.17	386.07	427.97	469.87	511.77	553.67								260
280	350.49	394.05	437.61	481.17	524.73	568.29								280
300	356.47	401.69	446.91	492.13	537.35									300

### Price Group 2

Price Category C

Width ► Drop ▼ cm	60cm	80cm	100cm	120cm	140cm	160cm	180cm	200cm	220cm	240cm	260cm	280cm	300cm	◀ Width ▼ Drop cm
100	359.80	394.38	428.96	463.54	498.12	532.70	567.28	601.86	636.44	671.02	705.60	740.18	774.76	100
120	367.11	404.02	440.93	477.84	514.75	551.66	588.57	625.48	662.39	699.30	736.21	773.12	810.03	120
140	374.76	413.67	452.58	491.49	530.40	569.31	608.22	647.13	686.04	724.95	763.86	802.77	841.68	140
160	382.41	423.31	464.21	505.11	546.01	586.91	627.81	668.71	709.61	750.51	791.41	832.31	873.21	160
180	389.73	432.62	475.51	518.40	561.29	604.18	647.07	689.96	732.85	775.74				180
200	397.37	442.26	487.15	532.04	576.93	621.82	666.71	711.60	756.49					200
220	405.02	451.91	498.80	545.69	592.58	639.47	686.36	733.25						220
240	412.34	461.55	510.76	559.97	609.18	658.39	707.60							240
260	419.99	471.20	522.41	573.62	624.83	676.04								260
280	427.30	480.50	533.70	586.90	640.10	693.30								280
300	434.95	490.15	545.35	600.55	655.75									300

### Price Group 3

Price Category C

Width ► Drop ▼ cm	60cm	80cm	100cm	120cm	140cm	160cm	180cm	200cm	220cm	240cm	260cm	280cm	300cm	◀ Width ▼ Drop cm
100	471.86	517.42	562.98	608.54	654.10	699.66	745.22	790.78	836.34	881.90	927.46	973.02	1018.58	100
120	481.50	529.72	577.94	626.16	674.38	722.60	770.82	819.04	867.26	915.48	963.70	1011.92	1060.14	120
140	491.48	542.36	593.24	644.12	695.00	745.88	796.76	847.64	898.52	949.40	1000.28	1051.16	1102.04	140
160	501.46	555.00	608.54	662.08	715.62	769.16	822.70	876.24	929.78	983.32	1036.86	1090.40	1143.94	160
180	511.10	567.30	623.50	679.70	735.90	792.10	848.30	904.50	960.70	1016.90				180
200	521.07	579.93	638.79	697.65	756.51	815.37	874.23	933.09	991.95					200
220	531.05	592.57	654.09	715.61	777.13	838.65	900.17	961.69						220
240	540.69	605.20	669.71	734.22	798.73	863.24	927.75							240
260	550.67	617.84	685.01	752.18	819.35	886.52								260
280	560.65	630.48	700.31	770.14	839.97	909.80								280
300	570.29	642.78	715.27	787.76	860.25									300

Child safety device (10482) – add on £12.48.

All prices shown exclude VAT



# Venetian Blind Systems

## SG 8910 Wooden Slat

Mono control wooden slat Venetian Blind System.  
Bass wood slat 50mm.

## SG 8960

Electrically operated Venetian Blind System.  
Average operating speed 3cm/sec.

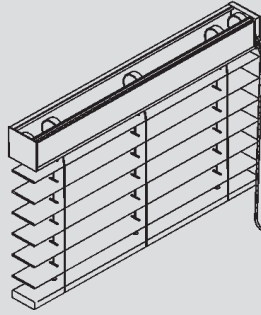

The prices in the table below comprise the complete system made-to-measure with 50mm slats ready to hang with universal bracket 8920. If sizes lie between the measurements shown, the price for the next size larger will apply. Headrail covered with actual slat to match. For F.R. treated wood please add £151.22/m<sup>2</sup> to prices below.

## SG 8910 – 50mm Slat size

Max. system width: 243cm  
Max. system drop: 275cm

Min. system width: 65cm  
Max. surface area: 4.6m<sup>2</sup>

Price Category C

Width ► Drop ▼ cm	80cm	100cm	120cm	140cm	160cm	180cm	200cm	220cm	245cm	◀ Width ▼ Drop cm
80	366.15	451.59	479.42	593.96	618.54	714.98	781.74	812.30	881.88	80
90	374.86	461.57	490.62	609.29	635.27	733.04	803.90	835.99	907.06	90
100	383.56	471.52	501.79	624.59	651.93	751.13	826.06	859.64	932.19	100
110	396.58	486.48	518.59	647.47	676.94	778.23	859.29	895.04	969.78	110
120	419.64	548.09	548.09	662.75	693.66	796.27	881.46	918.70	994.94	120
130	442.71	540.38	577.60	678.04	710.35	814.33	903.63	942.35	1020.05	130
140	462.18	562.66	602.63	708.70	743.73	850.47	947.89	989.58	1070.26	140
150	469.49	571.00	612.07	720.16	756.27	864.05	964.56	1007.33	1089.11	150
160	476.76	579.32	621.43	731.59	768.76	877.65	981.17	1025.05	1107.95	160
170	496.25	601.62	646.40	762.16	802.06	913.77	1003.31	1072.27	1158.18	170
180	516.76	625.44	672.70	793.48	835.88	950.94	1025.51	1095.93	1183.26	180
190	537.27	649.22	699.05	824.74	869.61	988.04	1069.78	1119.61	1208.35	190
200	552.75	666.98	719.00	849.16	896.18	1016.85	1103.05	1155.06		200
210	563.12	678.80	732.31	865.42	913.92	1036.05	1125.22			210
220	573.49	690.59	745.58	881.69	931.64	1055.19	1147.36			220
230	594.11	714.22	772.16	914.11	967.12	1093.63	1191.65			230
240	601.92	723.11	782.14	926.34	980.41	1106.56				240
250	609.69	732.00	792.09	938.54	993.69	1122.43				250
260	630.33	755.61	818.67	971.04	1029.16	1160.86				260
275	653.80	776.00	839.03	991.42	1047.25					275

## 50mm Slat

Slat Description

Basswood Collection - Use above price chart		Bamboo Collection - Use above price chart plus 30%		Abachi Collection - Use above price chart plus 35%	
Alabaster	Sin	Arcana	Innocent	Aro	
Alpine	Soft White	Armour	Karri	Elkin	
Clay	Stark	Cinder	Mari	Hibano	
Golden Oak	Storm	Cyber	Neo	Kota	
Light Oak	Walnut	Danta	Zaya	Muriva	
Linen	Yarrin	Flax			
Mystic		Haze			

Wooden slat Venetian blinds are made with natural wood. It is therefore an inherent feature of the product that variation in shade and graining as well as slight warping may occur.

TAPED VENETIAN System 8910 is available with fabric tapes at an additional cost of 7-5%.

Please enquire at Silent Gliss for information about the colours available.

## SG 8960 – Electrically Operated Venetian Blind System (50mm wooden slat)

Max. system width: 243cm      Min. system width: 65cm  
Max. system drop: 275cm      Max. surface area: 4.6m<sup>2</sup>

Electrically operated with integral 230v motor no. 11095. Supplied with special recess switch 0613 as standard. For pricing, add to relevant price in table above the sum of £1027.27

### 8960 Control Options

Radio control standard option is with System 9940, see page 28.

Radio control option with integrated receiver available only with 9940 controls – add on £232.27, see page 28.

System 8960 is available with fabric tapes at an additional cost of 7-5%.

SIDE-GUIDES are available for both systems at an additional cost of £35.27.

All prices shown  
exclude VAT





# Venetian Blind Systems

## SG 8910 Aluminium Slat

Mono control Venetian Blind System.  
Aluminium slat 50mm.

## SG 8960

Electrically operated Venetian Blind System.  
Average operating speed 3cm/sec.

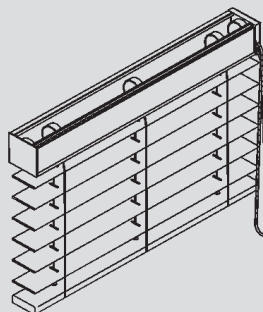

The prices in the table below comprise the complete system made-to-measure with 50mm slats ready to hang with universal bracket 8920. If sizes lie between the measurements shown, the price for the next size larger will apply. Headrail covered with actual slat to match. Plus coordinating or contrasting component options. Please refer to 8910 catalogue for recommended (standard) colour combinations. Multicoloured blinds please add 20% to prices below.

### SG 8910 – 50mm Slat size

Max. system width: 360cm      Min. system width: 65cm  
Max. system drop: 360cm      Max. surface area: 10m<sup>2</sup>

Price Category C

Width ▶ Drop ▼ cm	60cm	80cm	100cm	120cm	140cm	160cm	180cm	200cm	220cm	240cm	260cm	280cm	300cm	320cm	340cm	360cm	◀ Width ▼ Drop cm
60	248.75	282.01	308.49	353.55	380.02	418.90	445.37	475.40	494.40	520.00	546.78	572.37	595.44	624.75	647.82	670.89	60
70	252.92	288.50	315.44	362.77	389.70	430.85	458.66	490.07	510.42	537.40	565.57	592.51	616.97	647.61	672.08	696.54	70
80	257.14	294.07	323.27	371.06	400.26	442.80	471.12	504.75	526.43	554.81	584.32	612.64	638.45	671.41	696.33	721.26	80
90	262.24	299.63	330.22	380.28	410.82	453.82	484.41	519.38	541.63	572.17	603.12	633.66	659.97	694.27	721.46	748.66	90
100	266.46	306.12	337.17	388.57	420.50	465.77	497.70	533.18	557.64	589.57	621.86	653.79	681.50	717.14	745.72	774.30	100
110	270.63	311.68	345.00	397.79	431.06	477.66	510.11	547.86	573.71	606.98	640.61	673.93	703.85	740.88	769.93	798.97	110
120	274.86	317.24	351.95	406.08	440.79	488.74	523.39	562.53	591.58	626.24	661.26	695.92	727.23	765.60	796.91	828.22	120
130	279.95	323.73	359.78	415.30	451.35	500.68	536.73	571.24	607.60	643.65	680.01	716.06	748.76	788.52	821.17	853.82	130
140	284.18	329.29	366.68	423.59	461.03	511.70	551.87	585.86	623.61	661.05	698.80	736.19	770.23	811.38	846.25	881.11	140
150	288.35	334.85	373.63	432.81	471.59	523.65	564.29	599.67	639.68	678.46	717.55	756.33	791.76	835.12	870.50	905.89	150
160	292.57	341.34	381.46	441.10	481.27	537.45	577.57	614.34	655.70	695.87	736.35	776.47	814.11	857.99	894.76	931.53	160
170	297.67	346.90	388.41	450.32	491.83	548.48	590.86	629.02	670.89	713.28	755.09	797.48	835.64	880.86	919.89	958.93	170
180	301.89	352.47	396.24	458.61	504.24	560.42	603.32	643.70	723.27	766.99	810.25	853.97	893.47	940.96	980.46	1019.96	180
190	306.06	358.96	403.19	467.77	513.92	572.32	616.61	658.32	739.28	784.40	829.00	874.11	915.00	963.82	1004.71	1045.60	190
200	310.29	364.52	410.15	477.97	524.48	583.39	629.90	700.66	755.30	801.80	866.54	894.25	958.88	986.74	1029.85	1072.95	200
210	315.39	370.08	417.97	487.14	534.16	595.34	643.18	715.34	771.37	819.21	885.29	914.38	980.41	1009.61	1054.15	1098.60	210
220	319.61	376.57	424.93	495.48	544.72	607.24	684.13	730.01	787.38	836.62	904.08	934.52	1001.88	1033.35	1078.31	1123.27	220
230	323.83	382.13	434.56	504.65	554.40	618.31	697.46	744.64	803.40	854.02	922.83	954.71	1023.41	1055.18	1103.44	1150.66	230
240	328.00	387.69	441.51	521.28	564.96	658.79	710.75	759.32	819.47	871.43	941.63	974.84	1044.94	1079.08	1127.70	1176.31	240
250	332.23	393.31	448.46	530.50	574.64	669.81	723.16	773.12	834.61	887.96	961.25	994.98	1067.29	1102.00	1151.95	1201.91	250
260	337.33	399.74	456.29	538.79	585.19	681.76	736.45	787.80	850.63	905.37	980.05	1015.99	1088.81	1125.74	1177.03	1228.33	260
270	341.55	407.16	463.24	548.01	624.28	693.65	749.74	802.47	866.69	922.73	998.79	1036.13	1110.34	1148.60	1201.29	1253.97	270
280	345.72	412.77	471.07	556.30	633.97	704.73	763.02	817.10	882.71	940.13	1017.59	1056.27	1131.82	1171.47	1226.42		280
290	349.94	419.21	478.02	556.30	644.52	716.67	775.49	831.78	898.73	957.54	1036.33	1076.40	1153.34	1195.21	1250.68		290
300	355.04	424.77	484.98	565.52	654.20	728.57	788.77	845.58	914.79	974.95	1055.13	1096.54	1175.69	1218.13			300
310	359.26	430.39	492.80	573.81	664.76	739.64	802.06	860.26	930.81	992.35	1073.88	1116.67	1197.22	1241.00			310
320	363.44	436.82	499.76	583.03	674.50	751.59	814.88	874.88	946.83	1009.76	1092.68	1136.81	1197.22				320
330	367.66	442.39	507.53	591.32	685.05	763.49	829.56	889.56	962.84	1027.17	1111.42	1156.95	1218.75				330
340	372.76	448.00	514.49	600.54	695.61	774.56	841.56	904.24	978.04	1044.57	1111.42	1177.96					340
350	376.98	454.44	521.44	608.83	705.29	786.46	854.46	918.04	994.05	1061.98	1130.22	1198.10					350
360	381.15	460.00	529.27	618.05	715.85	798.40	868.40	932.67	1010.12	1079.39	1218.23						360

### SG 8960 – Electrically Operated Venetian Blind System (50mm aluminium slat)

Max. system width: 360cm      Min. system width: 65cm  
Max. system drop: 360cm      Max. surface area: 10m<sup>2</sup>

Electrically operated integral 230v motor no. 11095. Supplied with special recess switch 0613 as standard. For pricing, add to relevant price in table above the sum of £1027.27

#### 8960 Control Options

Radio control standard option is with System 9940, see page 28.

Radio control option with integrated receiver available only with 9940 controls – add on £232.27, see page 28.

SIDE-GUIDES are available for both systems at an additional cost of £35.27

All prices shown exclude VAT



## SG 8910 Leather Slat

Mono control leather slat Venetian Blind System with low descent mechanism (50mm).

## SG 8960

Electrically operated Venetian Blind System. Average operating speed 3cm/sec.

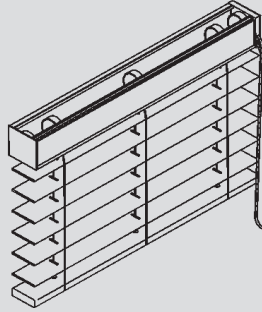

The prices in the table below comprise the complete system made-to-measure with 50mm slats ready to hang with universal bracket 8920. If sizes lie between the measurements shown, the price for the next size larger will apply. Plus coordinating or contrasting component options. Please refer to 8910 catalogue for recommended (standard) colour combinations. Leather venetian slats are a natural product, therefore slight variations in colour and texture are an inherent feature. Headrails are sprayed to match system colour as standard. Due to the varying sizes of hides, blinds over 1.4m wide may require a join in the leather. Please consult Silent Gliss for more information.

### SG 8910 – 50mm Slat size

Max. system width: 243cm      Min. system width: 65cm  
Max. system drop: 275cm      Max. surface area: 4.6m<sup>2</sup>

Width ► Drop ▼ cm	80cm	100cm	120cm	140cm	160cm	180cm	200cm	220cm	245cm	◀ Width ▼ Drop cm
80	731.77	872.48	1031.38	1171.99	1328.52	1468.56	1609.18	1753.46	1893.48	80
90	798.29	955.57	1131.76	1289.01	1461.43	1618.66	1775.95	1936.17	2093.44	90
100	865.46	1038.68	1231.48	1405.32	1594.97	1768.84	1942.09	2119.56	2293.40	100
110	931.97	1122.40	1331.80	1522.27	1728.53	1918.37	2108.81	2302.88	2493.38	110
120	998.48	1205.52	1431.51	1638.60	1861.45	2068.50	2275.60	2488.07	2695.12	120
130	1065.66	1289.30	1531.88	1755.52	1995.04	2218.68	2444.15	2671.46	2895.09	130
140	1132.17	1372.40	1631.59	1871.81	2127.95	2370.61	2610.93	2854.79	3095.09	140
150	1198.65	1455.51	1731.97	1988.80	2261.49	2520.16	2777.04	3038.17	3295.03	150
160	1265.81	1539.30	1831.63	2105.14	2396.87	2670.34	2943.78	3221.52	3495.00	160
170	1332.30	1622.41	1931.99	2222.10	2529.80	2820.51	3110.56	3404.21	3694.95	170
180	1398.83	1706.13	2031.71	2340.86	2663.34	2970.02	3277.33	3615.47	3922.80	180
190	1466.00	1789.24	2132.10	2457.17	2796.91	3120.15	3444.07	3798.81		190
200	1532.49	1872.34	2233.62	2574.15	2929.81	3270.32	3638.05	3982.18		200
210	1599.02	1956.11	2333.94	2690.44	3063.35	3420.51	3804.84	4165.57		210
220	1666.13	2039.24	2433.67	2807.39	3196.92	3597.83	3971.54			220
230	1732.65	2124.80	2534.05	2923.70	3329.84	3748.03	4138.34			230
240	1799.16	2207.90	2633.76	3041.33	3491.27	3898.21				240
250	1865.65	2291.00	2733.44	3156.99	3624.18	4047.70				250
260	1932.84	2374.77	2833.78	3273.92	3757.71					260
275	2001.16	2457.89	2933.49	3418.75	3891.30					275

### SG 8960 – Electrically Operated Venetian Blind System (50mm leather slat)

Max. system width: 243cm      Min. system width: 65cm  
Max. system drop: 275cm      Max. surface area: 4.6m<sup>2</sup>

Electrically operated with integral 230v motor no. 11095. Supplied with special recess switch 0613 as standard. For pricing, add to relevant price in table above the sum of **£1027.27**

#### 8960 Control Options

Radio control standard option is with System 9940, see page 28.

Radio control option with integrated receiver available only with 9940 controls – add on **£232.27**, see page 28.

**SIDE-GUIDES** are available for both systems at an additional cost of **£35.27**.

All prices shown exclude VAT



# Pleated Blind Systems

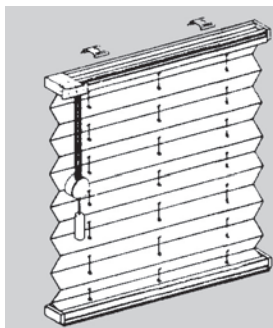

## SG 8500

Pleated Blind System supplied complete ready made.  
White aluminium head and bottom rail. Pleats 20mm.

Category C

Pleated Blind Systems are supplied made-to-measure, ready to install. White aluminium headrail and components are supplied as standard, brushed aluminium, grey and anthracite are also available. For special colours see page 73.

Please use our technical information leaflet to determine the required Plissée model and contact Silent Gliss for a price.

Choose from following model types:

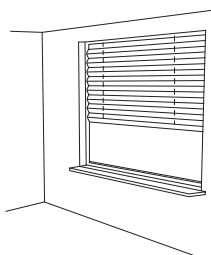

### Model Type 'A' – Vertical Freehanging

Electric Operation: AE10

Chain Operation: AK10

Pull Cord Operation: A010, A040, A070

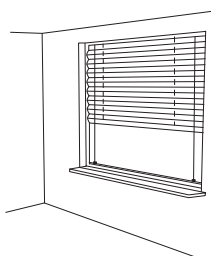

### Model Type 'B' – Vertical Side-Guide

Electrical Operation: BE10

Handle Operation: BB10, BB10U, BB15, BB20, BB20U, BB24, BB30, BB30U, BB34, BB35, BB40, BB80, BB81

Chain Operation: BK10

Pull Cord Operation: B010, B020, B075

Fixed: BF50, BF51

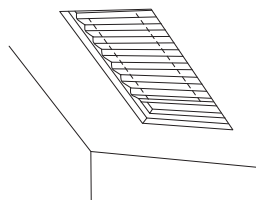

### Model Type 'D' – Inclined

Handle Operation: DB10, DB10U, DB20, DB20U

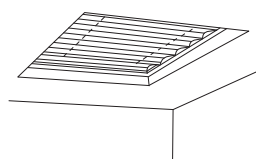

### Model Type 'P' – Horizontal

Handle Operation: PB10, PB40, PB41, PB60, PB61, PB70, PB71, PB80, PB81

Electrical Operation: PE10, PE11, PE60, PE61, PE70, PE71

Crank Operation: PR10, PR11

PRICING: Price on application – please contact Silent Gliss

All prices shown exclude VAT



## Logo and Digital Printing

We are able to print logos and images on a wide variety of fabrics, including Screens, Element, Mercurio and Colorama. It is important to note that the denser the fabric, the better the quality of the image transfer.

Suitable artwork must be provided on vector files with a reasonable size and high d.p.i. (dots per inch). Prices on application.

For more information please see Digital Printing brochure.

## Special Colours – Profile and Components

Standard stock colours are indicated and priced accordingly on the relevant system page.

In addition, any UK powder manufacturer's standard/stock RAL or BS colour may also be matched by spraying (delivery 4 weeks).

The following charges will apply:

	Price Ctg.
<b>Set-up charge (1 per colour)</b>	<b>E</b>
Standard/Classic Range stock	
RAL or BS colours: £311.50	
*Standard Silent Gliss colours (excluding chrome effect): £148.50	
Non-standard RAL or BS colours: POA	

**Plus add the following prices to the relevant assembled system price (use silver finish):**

£16.50 per metre of profile

£11.70 per set of endcovers/wall supports/endpieces/cord guides

For tracks with sprayable brackets please use bracket spraying cost below.

Note:

Profile should not be bent once sprayed.

Maximum sprayed profile length is 6 metres.

Nylon components sprayed to colour match may sustain damage in the future.

\*Standard Silent Gliss colours are not available on Pleated SG 8500 blinds or Skylight Systems SG 8600 or SG 8640.

### Metropole Coloured Extension Brackets

E

Spray charge: £9.62 per bracket and bracket cover  
Drilling charge: £5.79 per bracket  
Lead time approx. 6 weeks.

\*Only those brackets offered in Chrome are available in Chrome. Chroming of other brackets not possible.



# Made-to-measure Curtains

## Wave

Curtain prices need to be added to the hardware prices. Prices are for unlined curtains.  
For standard lining add 10% or for blackout lining add 15%.

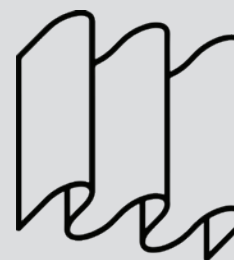

Price Category A

### Price Group 1 Fabrics

Colorama 1  
Colorama 1 Alu  
Colorama 1 Bioactive  
Colorama 1 Eco  
Colorama 1 Multicolour  
Colorama Acoustic  
Colorama Acoustic Multicolour  
Oscurante  
Polyflax  
Someo

Width ► Drop ▼	150cm	200cm	250cm	300cm	350cm	400cm	450cm	500cm	550cm	600cm	◀ Width ▼ Drop
Up to 300cm	472.52	629.99	787.53	944.99	1102.53	1260.02	1417.51	1575.00	1732.49	1889.98	Up to 9'10"
301-350cm	707.97	944.99	1182.03	1419.05	1656.09	1893.13	2130.14	2367.17	2604.20	2841.23	9'10"-11'5"
351-400cm	814.00	1086.91	1359.82	1632.70	1905.57	2178.50	2451.40	2724.29	2997.19	3270.09	11'5"-13'1"

### Price Group 2 Fabrics

Colorama 2  
Colorama 2 Bioactive  
Colorama 2 Eco  
Colorama 2 Multicolour  
Leviso  
Leviso Light  
Multicolour Natura  
Multicolour Panama  
Somnia  
Valere

Width ► Drop ▼	150cm	200cm	250cm	300cm	350cm	400cm	450cm	500cm	550cm	600cm	◀ Width ▼ Drop
Up to 300cm	648.71	863.92	1079.11	1294.31	1509.52	1724.69	1939.91	2155.09	2370.29	2585.49	Up to 9'10"
301-350cm	973.07	1295.85	1618.66	1941.45	2264.27	2587.05	2909.84	3232.67	3555.45	3878.26	9'10"-11'5"
351-400cm	1119.66	1490.80	1861.94	2233.07	2604.18	2975.33	3346.48	3717.61	4088.75	4459.89	11'5"-13'1"

### Price Group 3 Fabrics

Colorama Dimout  
Deep  
Multicolour Dimout  
Reflex

Width ► Drop ▼	150cm	200cm	250cm	300cm	350cm	400cm	450cm	500cm	550cm	600cm	◀ Width ▼ Drop
Up to 300cm	1266.24	1687.29	2108.31	2529.34	2950.39	3371.43	3792.48	4213.51	4634.55	5055.58	Up to 9'10"
301-350cm	1899.33	2530.92	3162.47	3794.05	4425.58	5057.16	5688.71	6320.28	6951.83	7583.41	9'10"-11'5"
351-400cm	2183.18	2909.84	3636.54	4363.21	5089.89	5816.57	6543.26	7269.94	7996.62	8723.30	11'5"-13'1"

### Covered Wave Heading

Available at an extra cost of £35.02 Per Metre width (of track).

(Please consider that the additional fold of fabric does mean that the maximum possible curtain drop will be slightly reduced. This flap uses 170mm of additional fabric which impacts on the maximum drop possible for curtains without turning and joining. So if you are specifying particularly long curtains please check first). Also consider that the thickness of the heading will increase slightly and therefore the stack size.

### Fabric Joining Information for Wave and SWISS Pleat Curtains

By reducing the number of joins the overall curtain appearance improves. The table below indicates the maximum drop available **without joins** for each fabric.

Max drop 170cm	Max drop 200cm	Max drop 240cm	Max drop 260cm	Max drop 280cm	Max drop 290cm	Max drop 300cm
Valere	Reflex	Colorama 1 Alu Somnia Leviso Leviso Light	Oscurante Someo	Colorama Dimout Multicolour Dimout Deep	Colorama 1 Multicolour Colorama 2 Multicolour Colorama Acoustic Colorama Acoustic Multicolor Polyflax Multicolour Natura Multicolour Panama	Colorama 1 Colorama 1 Bioactive Colorama 1 Eco Colorama 2 Colorama 2 Bioactive Colorama 2 Eco

We recommend (for Wave) that if dim-out and black-out fabrics have to be made with joins (due to the drop required - see above table) then they should be lined to reduce pinholes.

Our Wave curtain heading system is designed to encourage fabric to hang in a soft, continuous wave form from the top to the bottom of the curtain. However, the weave and design of some fabrics does not allow this floor-to-ceiling shape when using the 60mm glider cord. Therefore, we do not recommend the following fabrics are specified with 60mm Wave glider-cord:

Leviso  
Leviso Light  
Somnia  
Colorama Dimout

Multicolour Panama  
Multicolour Natrura  
Multicolour Dimout  
Deep

Colorama Dimout is not suitable for drops over 2.8m

All prices shown exclude VAT





# Made-to-measure Curtains

## Swiss Pleat Curtain

Curtain prices need to be added to the hardware prices.

Only available unlined.

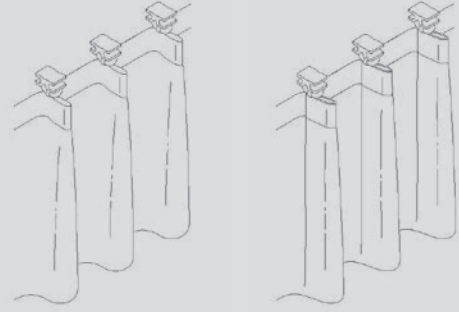

### Single Pleat (Approximate fullness 50%)

Price Category A

#### Price Group 1 Fabrics

Colorama 1  
Colorama 1 Alu  
Colorama 1 Bioactive  
Colorama 1 Eco  
Colorama 1 Multicolour  
Colorama Acoustic  
Colorama Acoustic Multicolour  
Oscurante  
Polyflax  
Someo

Width ▶ Drop ▼	150cm	200cm	250cm	300cm	350cm	400cm	450cm	500cm	550cm	600cm	◀ Width ▼ Drop
Up to 300cm	372.85	497.10	621.32	745.56	869.80	994.03	1118.27	1242.52	1366.77	1491.02	Up to 9'10"
301-350cm	559.29	745.63	931.98	1118.33	1304.68	1491.03	1677.38	1863.73	2050.08	2236.43	9'10"-11'5"
351-400cm	643.17	857.47	1071.75	1286.07	1500.37	1714.67	1928.97	2143.26	2357.56	2571.87	11'5"-13'1"

#### Price Group 2 Fabrics

Colorama 2  
Colorama 2 Bioactive  
Colorama 2 Eco  
Colorama 2 Multicolour  
Leviso  
Leviso Light  
Multicolour Natura  
Multicolour Panama  
Somnia  
Valere

\*Available May 2024

Width ▶ Drop ▼	150cm	200cm	250cm	300cm	350cm	400cm	450cm	500cm	550cm	600cm	◀ Width ▼ Drop
Up to 300cm	511.25	679.34	852.07	1022.48	1192.90	1363.77	1533.72	1704.14	1874.55	2044.96	Up to 9'10"
301-350cm	766.87	1022.48	1278.10	1564.96	1789.33	2044.94	2300.55	2556.17	2811.78	3067.40	9'10"-11'5"
351-400cm	881.89	1175.85	1469.84	1763.76	2057.72	2351.67	2645.63	2939.59	3233.54	3527.49	11'5"-13'1"

#### Price Group 3 Fabrics

Colorama Dimout  
Deep  
Multicolour Dimout  
Reflex

Width ▶ Drop ▼	150cm	200cm	250cm	300cm	350cm	400cm	450cm	500cm	550cm	600cm	◀ Width ▼ Drop
Up to 300cm	849.96	1133.28	1416.60	1699.92	1983.24	2266.56	2549.89	2833.21	3116.53	3399.85	Up to 9'10"
301-350cm	1274.95	1699.92	2124.90	2549.87	2974.85	3399.82	3824.80	4249.77	4674.75	5099.72	9'10"-11'5"
351-400cm	1466.18	1954.91	2443.63	2932.35	3421.07	3909.79	4398.51	4887.23	5375.95	5864.67	11'5"-13'1"

### Double Pleat (Approximate fullness 100%)

#### Price Group 1 Fabrics

Colorama 1  
Colorama 1 Alu  
Colorama 1 Bioactive  
Colorama 1 Eco  
Colorama 1 Multicolour  
Colorama Acoustic  
Colorama Acoustic Multicolour  
Oscurante  
Polyflax  
Someo

Width ▶ Drop ▼	150cm	200cm	250cm	300cm	350cm	400cm	450cm	500cm	550cm	600cm	◀ Width ▼ Drop
Up to 300cm	497.14	662.86	828.57	994.29	1160.00	1325.72	1491.43	1657.15	1822.86	1988.58	Up to 9'10"
301-350cm	745.71	994.29	1242.87	1491.45	1740.02	1988.60	2237.18	2485.76	2734.34	2982.92	9'10"-11'5"
351-400cm	857.57	1143.43	1429.30	1715.17	2001.03	2286.90	2572.77	2858.63	3144.50	3430.37	11'5"-13'1"

#### Price Group 2 Fabrics

Colorama 2  
Colorama 2 Bioactive  
Colorama 2 Eco  
Colorama 2 Multicolour  
Leviso  
Leviso Light  
Multicolour Natura  
Multicolour Panama  
Somnia  
Valere

Width ▶ Drop ▼	150cm	200cm	250cm	300cm	350cm	400cm	450cm	500cm	550cm	600cm	◀ Width ▼ Drop
Up to 300cm	681.71	908.95	1136.19	1363.42	1590.66	1817.90	2045.14	2272.37	2499.61	2726.85	Up to 9'10"
301-350cm	1022.57	1363.42	1704.27	2045.13	2385.98	2726.83	3067.68	3408.53	3749.38	4090.23	9'10"-11'5"
351-400cm	1175.97	1567.94	1959.92	2351.90	2743.88	3135.86	3527.85	3919.83	4311.81	4703.79	11'5"-13'1"

#### Price Group 3 Fabrics

Colorama Dimout  
Deep  
Multicolour Dimout  
Reflex

Width ▶ Drop ▼	150cm	200cm	250cm	300cm	350cm	400cm	450cm	500cm	550cm	600cm	◀ Width ▼ Drop
Up to 300cm	1133.34	1511.12	1888.90	2266.68	2644.46	3022.24	3400.02	3777.80	4155.58	4533.36	Up to 9'10"
301-350cm	1700.02	2266.68	2833.34	3400.01	3966.67	4533.34	5100.00	5666.67	6233.33	6799.99	9'10"-11'5"
351-400cm	1955.02	2606.69	3258.35	3910.02	4561.69	5213.36	5865.03	6516.71	7168.39	7820.07	11'5"-13'1"

Fabric joining information, please see table on page 74

All prices shown exclude VAT

# Price Index for Rails & Parts

All prices shown  
exclude V.A.T.

Product	Description	Unit Prices				Per Metre Price				Qty
		Each	Per 10	Per 100	Other Qty	Price	1m	100m	Other Lgth	
18R	Round Head Screw No.8, 25mm/1"			20.25						A
28C	Counter Sunk Screw No.8, 50mm/2"			25.13						A
0286	Cable Clips	0.16								A
0270	RACUB Module	524.32								C
0323	0.5m Blue patch cable	2.42								C
0565	Non latching recess switch, white, 1 gang	133.56								C
0566	Non latching recess switch, white, 2 gang	231.20								C
0567	Non latching recess switch, white, 3 gang	360.03								C
0568	Non latching recess switch, white, 4 gang	457.69								C
0569	Non latching recess switch, white, 6 gang	690.98								C
0593	Gland set for 5682	4.64								C
0614ST	Wireless switch, white	151.50								C
0615	Mains Switch, white, 1 gang, including back box	72.14								C
0616	Latching recess switch, white, 2 gang	97.22								C
0617	Latching recess switch, white, 3 gang	157.98								C
0618	Latching recess switch, white, 4 gang	189.99								C
0619	Latching recess switch, white, 6 gang	263.29								C
0661	Side guide wire					1.16				A
0839	Knot Holder	0.61								A
0921	Booster for 0450 system	619.41								C
0922	Power supply for 0921 booster	154.84								C
1021p	Rail, silver in 6 metre lengths only					8.44				A
1021p	Rail, silver, cut to size					9.23				A
1021p	Rail, white, 6 metre lengths only					18.17				A
1021p	Rail, white, cut to size					18.96				A
1025p	Rail, silver in 6 metre lengths only					8.44				A
1025p	Rail, silver, cut to size					9.23				A
1025p	Rail, white, in 6 metre lengths only					18.17				A
1025p	Rail, white, cut to size					18.96				A
1071	Rail, white in 6 metre lengths only					10.59				A
1071	Rail, white cut to size					11.65				A
1072	Endcap for 1070 Hand, white.		6.29	59.92						A
1080p	Rail, silver in 5 metre or 6 metre lengths only					11.26				A
1080p	Rail, silver, cut to size					12.31				A
1080p	Rail, white, in 5 metre or 6 metre lengths only, black in 6m lengths					11.87				A
1080p	Rail, white, black cut to size					13.22				A
1080p	Rail, matt white, anodic grey, antique bronze, charcoal in 6m. lengths only					24.31				A
1080p	Rail, matt white, anodic grey, antique bronze, charcoal cut to size					25.44				A
1082	Rail, white, in 5 metre or 6 metre lengths only (System 3000)					21.89				A
1082	Rail, white, cut to size (System 3000)					22.62				A
1090p	Rail, silver in 6 metre lengths only					9.65				A
1090p	Rail, silver, cut to size					10.48				A
1090p	Rail, white in 6 metre lengths only					9.98				A
1090p	Rail, white, cut to size					11.00				A
1105	Spacer	1.25	11.90	113.30						A
1128C	Counter sunk screw No.8, 37mm/1 1/2"			32.50						A
1128R	Round head screw No.8, 37 mm/1 1/2"			32.50						A
1148C	Counter sunk screw No.8, 31mm/1 1/4"			24.57						A
1280p	Rail, white, in 5/6 m lengths					16.05				A
1348R	Round head screw No.8, 44mm/1 3/4"			35.80						A
2006	Aluminium weight bar (4 metre length max) 28mm					18.67				A
2049	Gear Drive	35.93	342.08	3108.76						A
2059	Safety Clip		12.87							A
2081	Take up reel, 2120 system	16.02	143.72							A
2091	Endcover (for 2135 steel rod)	1.49	13.77	131.07						A
2093	Ring		3.39	32.13						A
2111	Hexagonal bar							6m	120.87	A
2111	Hexagonal bar, outer of 50 lengths							6m	90.63	A
2116	Touch and close profile							5m	125.89	A
2116	Touch and close profile, outer of 40 lengths							5m	113.30	A
2131	Short end-cover	2.42	21.63							A
2135	Steel rod							3m	11.12	A
2136	Tubular tape (for 2135 steel rod)						242.61			A
2136CR	Tubular tape, cream						249.14			A
2138	T' bracket A, silver, white with 1 rivetted clamp	54.43								C
2139	T' bracket A, silver, white with 2 rivetted clamps	54.89								C
2143	Cord connector	2.37	21.36							A
2144	Cross rail							4m	71.46	C
2145	Glider, wide channel for side rails	1.78	17.07							C
2151	Rail, silver in 6 metre lengths only					140.15				C
2151	Rail, silver, cut to size					154.21				C
2156	Drive shaft					18.12		6m	98.78	C
2160	Motor	1446.97								C
2163	Flat drawing tape 6mm							200m	576.78	A
2164T	Transparent ring tape							100m	397.62	A
2179	Endcover for 2211	2.05	19.32							A
2182	Sleeve and pin, pair				2.00	18.17				C
2188	Glider Insert for 2144	1.64	15.72							C
2189	Gear, system 2190	236.01								C
2191	Rail, silver, 6 metre lengths only					29.59				C
2191	Rail, silver, cut to size					32.54				C
2191	Rail, white, 6 metre lengths only					31.45				C
2191	Rail, white, cut to size					34.58				C

# Price Index for Rails & Parts

All prices shown  
exclude V.A.T.

Product	Description	Unit Prices				Per Metre Price				Qty
		Each	Per 10	Per 100	Other Qty	Price	1m	100m	Other Lgth	
2192	Belt drive endpiece set	16.81								C
2192W	Belt drive endpiece set, white	17.59								C
2193	Belt return set	16.81								C
2193W	Belt return set, white	17.18								C
2198	Pencil pleat tape							50m	390.60	A
2199	Oval wooden weight section							3m	21.25	A
2211	Velcro Profile					46.30		6m	252.38	A
2216	Cord							1000m	359.41	A
2221	Hook tape							100m	718.83	A
2230	Set, white, grey	35.30								C
2242	Connector	45.03								C
2248	Cross rod							6m	115.59	C
2255	Adjustable brake, white, black	9.67	92.08							A
2256	Adjustable brake, white, black	9.67	92.08							A
2301	Profile, White							5.8m	84.15	A
2301	Profile, Black							5.8m	100.97	A
2302	Clip bracket	1.50								A
2302	Clip bracket, Black	1.81								A
2307	Gear/Breakaway set (4:1), White	20.19								A
2307	Gear/Breakaway set (4:1), Black	24.24								A
2308	Spool with lift cord, White, 2305 systems	7.12								A
2308	Spool with lift cord, Black 2305 systems	8.54								A
2309	Hexagonal Bar							5m	11.76	A
2310	Plastic bead chain, White							250m	176.45	A
2311	Metal bead chain, (2305)							150m	421.53	A
2311/AB	Metal bead chain, Antique Brass (2305)							150m	756.36	A
2311/BL	Metal bead chain, Pewter (2305)							150m	756.36	A
2311/GD	Metal bead chain, Gold (2305)							150m	756.36	A
2312	Bead chain joiner	0.65								A
2319	Plastic chain joiner	0.13								A
2346	Clamp bracket	2.12								A
2346	Clamp bracket, Black	2.54								A
2347/50	50cm drop plastic chain loop, White	1.63								A
2347/75	75cm drop plastic chain loop, White	1.83								A
2347/100	100cm drop plastic chain loop, White	2.09								A
2347/125	125cm drop plastic chain loop, White	2.42								A
2347/150	150cm drop plastic chain loop, White	2.68								A
2347/175	175cm drop plastic chain loop, White	2.94								A
2347/200	200cm drop plastic chain loop, White	3.40								A
2363	Wall/ceiling bracket for 2350	7.16								A
2471	Bottom weight 5"/127mm	1.41		135.57						C
2473	Bottom weight 3½"/89mm	1.13		105.77						C
2479	Link chain 5"/127mm					1.32		500m	590.75	C
2481	Link chain 3½"/89mm					1.32		500m	590.75	C
2521	Face Fix Bracket (49.6mm)	2.32								C
2539	Touch and close pile section						241.17	25m	67.00	A
2573	Master Carrier for Electric Panel System	16.86								C
2601	Profile only, white					33.58				C
2601	Profile only, silver					32.77				C
2604	Guide	7.35								C
2605	Top clip 127mm each, white	0.55		47.83						C
2608	Endstop for 2601	17.33								C
2610	Endstop	2.66								C
2611	Stopper	2.40								C
2612	Brake	4.40								C
2613	Connector	19.78								C
2614	Recess profile, white, silver					48.59				C
2615	Recess profile, white, silver					33.68				C
2616	Bracket, white	5.43								C
2616	Bracket, silver	2.98								C
2618	Shaft	1.31								C
2620	Pilot Runner	9.16								C
2623	Rotation element (123mm)	3.23								C
2624	Rotation element (101mm)	3.23								C
2625	Rotation element (89mm)	3.23								C
2671	Bottom weight 89mm/3 1/3" without horns			135.57						C
2672	Bottom weight 127mm/5" without horns			105.77						C
2759	Crossrail, 0.13mm							4m	45.29	C
2813	Top clip 89mm, white	0.55		47.83						C
2821	Spacer (65mm)	1.06								C
2826	Chain connector	1.69	16.19							A
2849	PVC top clip			61.57						C
2865	Twin connector	2.22								C
2872	Plastic operating chain, white					4.09		250m reel	1013.49	C
2872	Plastic operating chain, black					13.24		250m reel	3252.30	C
2932	Recess profile, white, 6 metre lengths only					43.36				C
2932	Recess profile, white, cut to size					47.69				C
2941	Wedge	6.41								C
2948	Rail, white, 5 metre lengths only					103.13				C
2948	Rail, white, cut to size					113.48				C
3003	Clamp		58.07	522.62						C

# Price Index for Rails & Parts

All prices shown  
exclude V.A.T.

Product	Description	Unit Prices				Per Metre Price				Qty
		Each	Per 10	Per 100	Other Qty	Price	1m	100m	Other Lgth	
3004	Clamp		18.21	164.02						A
3008	Connecting bridge	14.76								A
3016	Endstop	0.64		48.06						A
3016	Endstop, Euroslot sachet of 2	2.50								A
3030	Pilot runner	2.65		232.15						A
3032	Spring Stop		10.57	95.01						A
3033	Clamp for 2900	3.45	31.07							C
3041	Clamp	9.29	92.87							A
3044	Clamp	2.31								C
3045	Metal overlap	5.46	49.17							A
3060	Clamp for 6465	0.87	8.33	79.42						A
3062	Connecting bridge for 1020 / 6465	3.53								A
3067	Connecting bridge for 6243 profile	5.14								A
3068A	Loop tape							250mtr Reel	815.70	A
3069	Child Safety Eyelet	0.86		84.44						A
3070	Twist eye endstop, white, black	0.96	8.53	76.27						A
3071	Screw twist endstop	3.58	34.02							A
3073	Bottom tape adjuster	0.50	3.76							A
3089	Glider with hook				20.00	13.62				A
3090	Cord, white							179.86		A
3090	Cord, black							179.86		A
3090A	Cord, white							500m	852.64	A
3091	Cord, black							179.85		A
3096	Connecting bridge 1090	19.10	181.93							A
3113	5cm spacer 1090		27.16	244.38						A
3151	Clearance spacer (for top boards)			84.82						A
3164	Hook & Latch Set	1.93		188.15						A
3165	Breakway Ring Set Softfold	1.25		121.49						A
3166	Breakway Ring Set Softfold Tape (per metre)					11.61				A
3175	Universal nylon bracket for 1090/1200 system	1.73	16.05	95.95						A
3176	Top fix bracket 1090/1200, white	1.73	16.05	95.95						A
3181	L' bracket A, silver, white with 1 rivetted clamp	11.44								C
3208A	Intermediate pulley, 3000, white	49.02	446.25							A
3213	Adjustable carrier 3000	3.71		328.62						A
3231	Endfix bracket 3000	12.87	122.17							A
3242	Nylon overlap	4.00	35.34	283.17						A
3242	Nylon overlap, Euroslot sachet of 1	5.13								A
3288	Endpiece set 3000, white	41.15			25.00	917.67				A
3289	Endpiece set, grey	83.55								A
3289	Endpiece set, white	83.55								A
3511	Glider			15.64	25000.00	3137.79				A
3532	Glider			33.15	5000.00	1328.43				A
3533	Glider, white, black			17.53	25000.00	3505.74				A
3533	Glider, white sachets of 25 x 25	108.31								A
3533	Glider, white Euroslot sachets of 25	5.74								A
3534	Glider in strip form, white, black				1000.00	149.96				A
3548	Retrofit glider				25.00	8.09				A
3548	Retrofit glider			29.54	1000.00	294.80				A
3562	Standard tape						303.91			A
3570	Rotating glider		3.85	33.68						A
3571	Hook			15.44	35000.00	4535.00				A
3571	Hook, sachet of 25 x 25	103.09								A
3571	Hook, Euroslot sachet of 25	5.23								A
3580	Glider/hook			62.27	5000.00	2970.43				A
3582	Plastic hook, white, black			13.71						A
3582	Plastic hook, white sachets of 25 x 25	115.14			625.00	115.12				A
3582	Plastic hook, white, black outer 20000				20000.00	2435.13				A
3582	Plastic hook, white, black outer 1000				1000.00	128.18				A
3582	Plastic hook, white Euroslot sachets of 25				25.00	4.82				A
3599	2 prong hook, white, black			21.50	25000.00	4094.86				A
3599	2 prong hook, white sachets of 25 x 25	164.29								A
3599	2 prong hook, white Euroslot sachets of 25	7.07								A
3600	Picture hanging set	29.00								A
3602	Wall support 1080, white	6.57	59.64							A
3603	Top fix bracket, white, black	2.33	21.18	192.85						A
3603	Top fix bracket, Euroslot sachets of 2, white	6.06								A
3604	Nylon Corner Piece (White Only)	4.50								A
3605	Endcover 1080, white, black	3.24	29.50	281.00						A
3606	Snap fastener 1080	1.64	12.87							A
3611	Ceiling stud 1085	2.87								A
3612	Sleeve for 3610	6.35								A
3618	Metal wall support	9.13	82.15							A
3620	Connecting bridge	17.25	161.69							A
3626	Return fixing bracket	5.49	49.38							A
3630	Universal nylon bracket, white, black	2.24	17.77	161.74						A
3630	Universal nylon bracket, white Euroslot sachet of 2	5.83								A
3630	Universal nylon bracket, gold, brown	2.50	22.44							A
3634	Height adjuster	5.04								A
3637A	Cord							500m	411.44	A
3638	Re-inforced corner piece, grey, white	3.77	34.43	313.68						A
3639	Hanger rod assembly complete	29.13								A

# Price Index for Rails & Parts

All prices shown  
exclude V.A.T.

Product	Description	Unit Prices				Per Metre Price				Qty
		Each	Per 10	Per 100	Other Qty	Price	1m	100m	Other Lgth	
3655	Long universal bracket	3.80	36.16	329.07						A
3660	Extra long universal bracket	4.73								A
3660	Extra long universal bracket, Euroslot sachet of 1	6.18								A
3663	Profile hook	4.37								A
3667	Endcover/stop, white, grey, black	1.76	17.02	162.31						A
3667	Endcover/stop, white, grey, Euroslot sachets of 2	4.94								A
3667	Endcover/stop, matt white, anodic grey, antique bronze, charcoal	3.63	34.58	329.38						A
3802	Connecting bridge	19.03								A
3825	Clamp		27.03	258.69						A
3826	Top fix bracket, white, black	1.78	16.22	146.01						A
3832	Twist clamp	3.41								A
3833A	Intermediate pulley for 3840, white, black	71.43								A
3833A	Intermediate pulley for 3840, matt white, grey, anodic grey, antique bronze, charcoal	78.23								A
3836	Face fix bracket, white	3.68								A
3841	Rail, silver, white, black in 6 metre lengths only					24.04				A
3841	Rail, silver, white, black cut to size					26.70				A
3841	Rail, matt white, anodic grey, antique bronze, charcoal in 6 metre lengths only					42.72				A
3841	Rail, matt white, anodic grey, antique bronze, charcoal, cut to size					45.11				A
3842	Endcap for 6840 Hand, white, grey, black	0.65	5.88	52.28						A
3842	Endcap for 6840 Hand, anodic grey, antique bronze, charcoal, silver	5.62	53.56	509.75						A
3845	Endpiece set, white, grey, black	23.35								A
3845	Endpiece set, anodic grey, antique bronze, charcoal	31.49								A
3846	Endpiece set, white, grey	32.30								A
3914	Bracket for return profile	19.31								A
3915	Endpiece set				20.00	528.66				A
3915	Endpiece set				50.00	1190.01				A
3916	Pilot runner for multi-stack system	2.24	19.93							A
3917	Pilot runner	3.06		291.22						A
3922	Roller gliders in strip form, outer of 1000				1000.00	604.62				A
3922	Roller gliders in strip form, outer of 8000				8000.00	4177.54				A
3929A	Intermediate pulley	75.84	722.01							A
3932	Spring stop	1.10	10.39							A
3933	Click glider in strip form, outer of 1000				1000.00	384.15				A
3935	Overlap arm (System 3900)	28.54	272.01							A
3935A	Combination overlap with 'S' hook attachment 3949	32.15	306.25							A
3936	Overlap arm (System 3900)				20.00	288.00				A
3936A	Combination overlap with 'S' hook attachment 3949	19.32	183.96							A
3939	Pilot runner	2.60		249.61						A
3942	Intermediate stop	4.37	42.42							A
3947	Pair of magnetic gliders		123.69							A
3971	Rail, white in 6 metre lengths only					29.41				C
3971	Rail white cut to size					32.35				C
3975	Overlap for pulling by hand (1280)	54.61	520.13							A
3982	Rail, white, available in 5 metre or 6 metre lengths					25.13				A
3985	Endcover in white 1280			278.76						A
4223	Plastic strip with adhesive 12mm					4.41				C
4226	Standard adhesive tape, 30mm							54m	390.39	C
4845	Metal bead chain (2020/2120)							125m	644.83	A
4845BR	Metal bead chain, brass (2020/2120)							125m	1212.82	A
5118	Wedge, white, black	6.92								C
5130	Drive belt for 2190/2195					19.60				C
5190	Motor 100-250V AC with 5 Metre lead	304.53								A
5192	Motor 24V DC	327.37								A
5193	Motor 100-250V AC with mains control	441.17								A
5339	Lead with in-line connector	133.76								C
5670	Overlap	83.69								C
5682	Hood	19.78								C
5684	Connector	42.40								C
5736	Surface Relay Socket	194.42								C
5778	Special plug for cable 5779, pair	4.66			2.00	9.31				C
5779	4 core low voltage connecting cable					6.36				C
5782ST	Single Channel radio handset white	135.37								C
5784ST	Multi channel radio handset white	178.41								C
5805	Motor for 5800	14390.51								C
5806	Pilot runner	41.12								C
5809	Roller glider		139.08							C
5810	Profile					145.29				C
5811	Overlap	282.26								C
5813	Floor frame	1770.14								C
5814	Cable					44.01				C
5815	Cord guide return	415.88								C
5816	Cord guide	544.04								C
5824	Endstop	44.73								C
5829	2 hole fixing plate	12.86								C
5834	Double pilot	301.52								C
6010p	Rail, white, black in 6 metre lengths only					22.39				A
6010p	Rail, white, black, cut to size					24.62				A
6018	Endcap, white, black for 6010		7.88	75.03						A
6021p	Rail, white, in 6 metre lengths					15.21				A
6024	Panel glide connecting bridge	16.42								C
6053	Spring stop	1.78	16.49							A



# Price Index for Rails & Parts

All prices shown  
exclude V.A.T.

Product	Description	Unit Prices				Per Metre Price				Qty
		Each	Per 10	Per 100	Other Qty	Price	1m	100m	Other Lgth	
6063	Overlap	14.13	128.53	1201.24						A
6063	Overlap Black	18.52	176.40	1680.00						A
6063R	Overlap arm with rollers for 30mm Corded	24.45								A
6064	Screw twist endstop, white	1.72	14.59							A
6065	Twist eye endstop, white, black	1.51	13.84	127.31						A
6070	Cord 6200/6370						504.26			C
6079	Overlap	45.99								C
6086	Spring stop, white, black	2.51	23.61	214.45						A
6094	Roller glider with hook		41.38	393.68						A
6098	Roller glider with eye, white, black		34.90	331.08						A
6099	Wave roller glider (80mm) white							50m	3621.09	A
6101	Rail, Black and Matt White in 6m only, White in 4.5m, 5m, 5.5m, 6m lengths only					41.90				A
6101	Rail, Silver in 4.5m, 5m, 5.5m, 6m lengths only					37.26				A
6101	Rail, Gunmetal, Antique Bronze, Bronze, Anodic Grey, Charcoal, Slate Grey 6m lengths only , Rail, chrome effect, 4m lengths only					54.07				A
6103	Rail, Silver, White, Matt White, Ecru, Black in 6 metre lengths only					38.61				A
6103	Rail, Antique Bronze, Anodic Grey, Bronze, Charcoal, Gunmetal, Slate Grey, Sand, Ochre, Taupe, Chrome effect (Chrome effect 4m lengths max)					56.52				A
6105	Hanger with plate, 61cm, white, silver	134.89								A
6105	Hanger with plate, 61cm, black	141.61								A
6105	Hanger with plate, 91cm, white, silver	141.50								A
6105	Hanger with plate, 91cm, black	148.59								A
6106	Rail, White, Matt White Ecru Black in 6 metre lengths only					50.66				A
6106	Rail, Antique Bronze, Anodic Grey, Bronze, Charcoal, Gunmetal, Slate Grey, Sand, Ochre, Taupe, Chrome effect (Chrome effect 4m lengths max)					69.64				A
6107	V-Hanger with plate, 61cm, white, silver	181.02								
6107	V-Hanger with plate, 61cm, black	190.03								
6107	V-Hanger with plate, 91cm, white, silver	194.23								
6107	V-Hanger with plate, 91cm, black	204.00								
6110	Dustcover, white					4.14				A
6122	Endstop			367.52						A
6124	Twist fixing plate	6.54								A
6124	Twist fixing plate, black	10.47								A
6137	Ceiling fix plate, single, silver	9.10								A
6137	Ceiling fix plate, single, white	9.98								A
6138	Ceiling fix plate, double, silver	10.13								A
6138	Ceiling fix plate, double, white	11.12								A
6141	Insert		31.99	294.73						A
6143	Glider			23.49	1000.00	219.34				A
6146	Hook			24.80	12.00	3.67				A
6147	Glider hook				20.00	15.85				A
6147	Glider hook				500.00	317.27				A
6147	Glider hook				8000.00	4250.34				A
6148	Glider (yellow)				1000.00	352.82				A
6149	Lead glider (blue)			86.73						A
6151	Ceiling support 3mm, Antique Bronze, Bronze, Anodic Grey, Black, Bronze, Charcoal, Ecru, Gunmetal, Slate Grey, Silver, Sand, Ochre, Taupe, White, Matt White, Chrome effect for 30mm Hand	11.30	101.76							A
6152	Ceiling support 9mm, Antique Bronze, Bronze, Anodic Grey, Black, Bronze, Charcoal, Ecru, Gunmetal, Slate Grey, Silver, Sand, Ochre, Taupe, White, Matt White, Chrome effect for 30mm Cord	22.58	203.54							A
6160	Track insert	21.50								A
6160	Track insert, black	57.72								A
6173	Connecting bridge	6.71	64.00							A
6175	Mini hanger, white / silver	34.40								A
6175	Mini hanger, Black, Antique Bronze, Anodic Grey, Bronze, Charcoal, Ecru, Gunmetal, Matt White, Ochre, Slate Grey, Sand, Taupe	45.25	430.98							A
6187	Dummy ceiling support sleeve, silver	18.60								A
6187	Dummy ceiling support sleeve, white	18.42								A
6190	Hanger rod assembly, complete including 6192 ceiling support and 6191 rod 61 cm (2') silver	58.22								A
6190	Hanger rod assembly, complete including 6192 ceiling support and 6191 rod 61 cm (2') white	61.43								A
6190	Hanger rod assembly, complete including 6192 ceiling support and 6191 rod 61 cm (2') black	69.49								A
6190	Hanger rod assembly, complete including 6192 ceiling support and 6191 rod 91 cm (3') silver	60.81								A
6190	Hanger rod assembly, complete including 6192 ceiling support and 6191 rod 91 cm (3') white	64.89								A
6190	Hanger rod assembly, complete including 6192 ceiling support and 6191 rod 91 cm (3') black	78.06								A
6191	Hanger tube, silver					20.07				A
6191	Hanger tube, white					22.30				A
6191	Hanger tube, black					26.77				A
6192B	Ceiling support, 100mm complete with stud 6193 and 2 grub screws, silver	41.90								A
6192B	Ceiling support, 100mm complete with stud 6193 and 2 grub screws, white	44.00								A
6192B	Ceiling support, 100mm complete with stud 6193 and 2 grub screws, black	47.12								A
6193	Stud for ceiling support	4.02								A
6194	Insert	6.72								A
6199	Internal connecting bridge	15.64								A
6203	Connecting bridge	35.02								C
6209	Clamp	10.41	98.78							C

# Price Index for Rails & Parts

All prices shown  
exclude V.A.T.

Product	Description	Unit Prices				Per Metre Price				Qty
		Each	Per 10	Per 100	Other Qty	Price	1m	100m	Other Lgth	
6214	Adjustable pilot	14.76								C
6224	Nylon clamp	17.96								C
6227	Master runner	14.76								C
6228	Double fixing plate	8.12								C
6243p	Rail White in 6 metre lengths only					15.17				A
6268	Hanger	14.11								C
6269	Connecting bridge for 6293	52.78								A
6283	Roller glider		21.66	205.49						A
6288	Plastic overlap arm, white, black	4.49	40.47	364.00						A
6290p	Rail, White, in 6m lengths					9.27				A
6293p	Rail, white in 6 metre lengths only					39.00				A
6293p	Rail, white cut to size					42.90				A
6349	Wave curtain tape, white, 50m, 100m rolls only						362.34	50.00	185.58	A
6349	Wave curtain tape, black, 50m, 100m rolls only						434.82	50.00	222.68	A
6354	Pilot runner	7.76	73.82							A
6363	Wave Iron-on hemming tape						257.98			A
6364	Extension arm, white, black	6.30	56.73							A
6365	Hanger, white, black	5.25	47.28							A
6366	Draw rod carrier, white, black	9.95	89.58							A
6367	Master carrier	3.15	28.37							A
6368	Carrier	3.15	28.37							A
6369	Insert for face fixing 6370	6.36								C
6371	Rail, silver in 5 metre and 6 metre lengths only					40.65				C
6371	Rail, silver, cut to size					46.98				C
6376	Connecting bridge	21.16	201.05							C
6377	Endpiece set, grey	87.00	828.64							C
6380p	Rail, white in 6 metre lengths only					23.46				A
6380p	Rail, white cut to size					25.81				A
6381	End cap white for 6380			367.10						A
6398	Clip	1.23	11.11							C
6466	Rail, white, black in 6 metre lengths only					23.85				A
6466	Rail, white, black cut to size					26.25				A
6471	Endcover white, black for 6465		14.94	142.34						A
6501	V-hanger, silver	94.51			metre drop	35.13				A
6501	V-hanger, white	103.99			metre drop	38.63				A
6503	Wall bracket complete, white, 25mm long with 50mm projection	19.63								A
6503	Wall bracket complete, silver, 25mm long with 50mm projection	17.82								A
6503	Wall bracket complete, white, 50mm long with 50mm projection	26.14								A
6503	Wall bracket complete, silver, 50mm long with 50mm projection	23.08								A
6503	Wall bracket complete, white, 100mm long with 50mm projection	32.41								A
6503	Wall bracket complete, silver, 100mm long with 50mm projection	28.85								A
6503	Wall bracket complete, white, 200mm long with 50mm projection	45.34								A
6503	Wall bracket complete, silver, 200mm long with 50mm projection	40.88								A
6503	Wall bracket complete, white, 50mm long with 100mm projection	38.57								A
6503	Wall bracket complete, silver, 50mm long with 100mm projection	34.35								A
6503	Wall bracket complete, white, 100mm long with 100mm projection	53.43								A
6503	Wall bracket complete, silver, 100mm long with 100mm projection	48.58								A
6503	Wall bracket complete, white, 75mm long with 150mm projection	93.63								A
6503	Wall brackets complete, silver 75mm long with 150mm projection	85.11								A
6512	Connecting bridge, silver, white	73.48								A
6512	Connecting bridge, black	80.90								A
6514M	T-junction, single, silver	14.44								A
6514M	T-junction, single, white	17.13								A
6519	Silver V-hanger rod					14.21				A
6521	External bridge 6103, silver	90.78								A
6521	External bridge 6103, white	96.74								A
6524A	Diagonal fixing support, silver, white	80.46								A
6525A	Double T-junction, silver	19.88								A
6525A	Double T-junction, white	22.99								A
6530	V Hanger, black, 61cm long	290.53								A
6530	V Hanger, black, 91cm long	299.10								A
6610	Wall support, white	10.32								A
6610	Wall support, grey	10.31								A
6610	Wall support, black	22.14								A
6611	Endcover, grey	7.99								A
6611	Endcover, white	9.01								A
6611	Endcover, black	10.81								A
6620	Wall bracket 6103, grey	24.27	231.13							A
6620	Wall bracket 6103, white	18.55	167.73							A
6625A	Fixing sleeve complete for V-hanger/diagonal support, silver	38.40								A
6625A	Fixing sleeve complete for V-hanger/diagonal support, white	43.34								A
6628	V-hanger track insert	29.11								A
6632	Internal connecting bridge 6103	12.23								A
6635	Internal connecting bridge	25.36								A
6639	Track insert	3.62								A
6655	Wall Support	41.97								A
6663	Wall brackets connector plate complete	50.75								A
6666	Safety connecting bridge	77.31								A
6669	Dustcap for 6650 (2.5mtr length)							1m	7.62	A
6671	Washer insert for countersunk screw	2.53								A
6672	Cover for 6671	3.19								A

# Price Index for Rails & Parts

All prices shown  
exclude V.A.T.

Product	Description	Unit Prices				Per Metre Price				Qty
		Each	Per 10	Per 100	Other Qty	Price	1m	100m	Other Lgth	
6675	Safety Device	53.02								A
6677	V-Hanger safety device	81.29								A
6679	Acrylic disc for use with 6655	9.86								A
6739	Machine screw M4 6mm/ 1/4"			20.80						A
6748	Machine screw M4 8mm/ 5/16"			28.98						A
6770	Locking pin	2.05								A
6771	Vine eye	2.37								A
6784	Machine screw for 6639			49.44						A
6789	Grub screw	0.35								A
6794	Screw for 5600 Direct Fix	0.42		40.00						C
6798	Machine screw M4 12mm/ 1/2"			30.40						A
6821	Rail, white in 6 metre lengths only					23.13				A
6821	Rail, white cut to size					25.45				A
6822	Rail, white in 6 metre lengths only					12.94				A
6822	Rail, white cut to size					14.23				A
6823	Endcover with screw white for 6820	8.01	76.31	726.72						A
6824	Endcover with screw white for 1020	7.59	72.37	689.26						A
6835A	Round head No. 4 screw 12mm/ 1/2"			11.64						A
6835B	Round head No. 4 screw 25mm/ 1"			20.08						A
6944	Screw Countersunk Head M3 x 8			17.63						A
6938	Screw Countersunk Head M5 x 10			26.34						A
7002	Rail protector	7.55								A
8013	Bottom bar clip (25mm)	1.83	16.63							C
8235	Wire base short, white, grey, black	4.78								C
8236	Wire base long, white, grey, black	6.39								C
8237	Wire holder, white, grey, black	6.50								C
8249A	Locking ring	0.84								C
8920	Universal bracket for 8910	9.51								C
9060	Motor, white, grey	1185.98								C
9060	Motor, black	1423.17								C
9060	Motor, white, grey, slow motor	1185.98								C
9063	Radio module set, white, grey (compatible with 9940)	221.99								C
9063	Radio module set, black (compatible with 9940)	266.39								C
9068	Single channel receiver	512.76								C
9090	Motor for 2650/2950	937.04								C
9091	Motor with receiver for 2650/2950	1065.22								C
9916	In line connector for electric Roller blinds	84.09								C
9944	Single channel receiver, non latching	393.18								C
9945	Single channel receiver, latching	355.50								C
9947	Control unit DC 24V	232.33								C
9953	Volt free switching module	252.23								C
9959	Surface relay socket	194.42								C
9960	Move server unit	POA								C
10040	Power supply set for 2650, 2950	163.46								C
10048	Power cable with plug for 5090, 2650 and 2950	9.55								C
10075	Lead weight					4.58				A
10076	Fabric weight white	15.76								A
10076/1	Fabric weight s/steel	10.73								A
10122	Profile cut to size, white, (for System 2700, 2 channel)					47.56				C
10123	Profile cut to size, white, (for System 2700, 3 channel)					76.74				C
10124	Profile cut to size, white, (for System 2700, 4 channel)					81.71				C
10125	Profile cut to size, white, (for System 2700, 5 channel)					88.76				C
10132	Profile cut to size, white (for System 2730, 2 channel)					37.50				C
10133	Profile cut to size, white (for System 2730, 3 channel)					58.88				C
10134	Profile cut to size, white (for System 2730, 4 channel)					80.24				C
10135	Profile cut to size, white (for System 2730, 5 channel)					101.61				C
10136	Top fix bracket for 2700, 2 channel profile only	4.64	44.13							C
10137	Top fix bracket for 2700, 3, 4 and 5 channel profiles	5.42	51.50							C
10139	Screw	0.11								A
10140	Angle with screw	1.95								C
10142	Cover for 2 channel 2700 profile	2.86								C
10143	Cover for 3 channel 2700 profile	2.88								C
10144	Cover for 4 channel 2700 profile	2.94								C
10145	Cover for 5 channel 2700 profile	4.11								C
10146	Angle with screw	1.95								C
10148	Eyelet with screw	2.57								C
10150	Pilot runner with screw for 2700	5.11								C
10153	cord guide for 3 channel 2700 profile	10.38								C
10154	cord guide for 4 channel 2700 profile	10.47								C
10155	cord guide for 5 channel 2700 profile	12.32								C
10156	End stop with screw for 2700	4.05								C
10157	Wedge, white, black for 2700, 6870 and 3870 recess profiles	2.74	26.00							A
10172	Recess profile, 2 channel, (for System 2700)					41.75				C
10173	Recess profile, 3 channel, (for System 2700)					41.75				C
10174	Recess profile, 4 channel, (for System 2700)					41.75				C
10175	Recess profile, 5 channel, (for System 2700)					41.75				C
10177	Connecting bridge for 2730	7.45								C
10180	Carrier assembled, flexible, (for system 2730)					53.86				C
10200	Roller for 2700 carrier	1.81								C
10230	Carrier assembled, white, (for system 2700)					50.16				C
10234	Glass weight bar 16mm	2.07								C

# Price Index for Rails & Parts

All prices shown  
exclude V.A.T.

Product	Description	Unit Prices				Per Metre Price				Qty	
		Each	Per 10	Per 100	Other Qty	Price	1m	100m	Other Lgth		Price
10252	2700 carrier end cover left	1.02								C	
10253	2700 carrier end cover right	1.02								C	
10281	Slot nut (for System 2730)		21.38							C	
10300	Single channel hand held remote	289.04								C	
10302	5 + 1 channel hand held remote	289.04								C	
10303	10 + 2 + 1 channel hand held remote	352.29								C	
10399	Design Fascia for 2730, white				per system	5.16	31.57			C	
10430	Draw rod 50cm aluminium	12.22								A	
10430	Draw rod 50cm white	13.25								A	
10430	Draw rod 50cm black	15.91								A	
10431	Draw rod 75cm aluminium	14.22								A	
10431	Draw rod 75cm white	15.87								A	
10431	Draw rod 75cm black	19.04								A	
10432	Draw rod 100cm aluminium	16.11								A	
10432	Draw rod 100cm white	18.12								A	
10432	Draw rod 100cm black	21.75								A	
10433	Draw rod 125cm aluminium	17.56								A	
10433	Draw rod 125cm white	19.88								A	
10433	Draw rod 125cm black	23.86								A	
10434	Draw rod 150cm aluminium	18.85								A	
10434	Draw rod 150cm white	21.47								A	
10434	Draw rod 150cm black	25.76								A	
10534	Continuous headrail profile for 4900, 4910, 4960 silver, white (per m width)						25.01			A	
10539	Optional click bracket for fixing continuous headrail 10534	5.95								C	
10632	Intermediate bracket cover for 4910, 4960 white, grey, black	7.12								C	
10645	Pull grip set	16.80								C	
10707	Cushion, white, grey, black 4910	2.07								C	
10709	Chain stop	1.06								C	
10717	Screw for 6243 Profile	0.45		42.96						A	
10731	Cord retainer, white, black	0.53								E	
10804	15 + 5 + 1 channel hand held-remote.	352.28								C	
10815	Cover, white, grey, black	1.95								A	
10816	Motor cover, white, grey, black	1.48								C	
10817	Motor case holder, white, grey, black	10.32								C	
10819	Belt return set, white, grey, black	16.48								C	
10820	Overlap arm, straight, black	6.23								C	
10821	Overlap arm, bent, white, black	6.68								C	
10821L	Long overlap arm, bent	52.50								C	
10822	Master carrier set, white, black	7.12								C	
10823	Belt connector arm	2.29								A	
10824	Belt connector pin	2.29								A	
10825	Drive belt							703.96		A	
10826	Overlap support set , white, black	7.87								C	
10831	Connecting bridge 5600	17.29								C	
10836	Mask pair stack, white, black	2.21								A	
10837	Pilot runner arm, white, black	2.97								C	
10838	Pilot runner set , white, black	33.54								C	
10840	2C Roller Glider, white, black	3.71	36.36	339.90						C	
10844	Wave endstop (motor), white, grey, black	2.08								C	
10845	Wave master carrier, white, black single stack (80mm)	18.55								C	
10850	Rail, white, black, silver 6 metre lengths only						22.80			C	
10850	Rail, white, black, silver cut to size						25.08			C	
10852	Wave roller glider cord (80mm), white, black 6.5mm channel								57m	3946.73	C
10854	Wave overlap support arm, white, black	3.03								A	
10856	Wave end stop (return end), white, grey, black	3.34								C	
10862	Recess profile, white, black for 5600, white, 6 metre lengths only						28.93			C	
10862	Recess profile, white, black for 5600, white, cut to size						31.83			C	
10863	Recess mask, motor, white, black	5.71								C	
10864	Recess mask, belt return, white, black	4.97								C	
10865	Mounting support plate	2.45								C	
10867	M4 X 16 Pan Head Screw for 5100	0.10								A	
10869	Wave roller glider cord (60mm), white, black, 6.5mm channel								43m	3771.96	C
10886	Wave overlap arm, pilot runner set, white, black	9.35								C	
10887	Wave overlap arm set, white, black	9.57								C	
10905	Wave glider cord, white (80mm), 6.5mm channel								50m	1938.02	A
10906	Wave glider cord, white (60mm), 6.5mm channel								50m	2325.25	A
10924	Wave glider support, white, black	2.40								A	
10923	Pan head screw M4 x 12 for 3970			58.82						C	
10925	Rail, white 6 metre lengths only (System 5100)								6m	165.61	A
10925	Rail, white, cut to size (System 5100)						28.98			A	
10926	Clamp	5.10	48.58	462.70						A	
10927	Hook for 5100	2.83								A	
10931	Roller Glider for 10925	0.52								A	
10933	Belt return & Motor Holder Set	9.78								A	
10936	Overlap Arm Set	15.05								A	
10940	Belt Return for 5100	8.21								A	
10943	Connecting bridge for 5100	19.49								A	
10945	Endstop for 5100	2.12								A	
10946	1 Channel Transmitter White	66.23								A	
10947	2+1 Channel Transmitter White	81.27								A	
10948	6+1 Channel Transmitter White	81.27								A	

# Price Index for Rails & Parts

All prices shown  
exclude V.A.T.

Product	Description	Unit Prices					Per Metre Price				Qty
		Each	Per 10	Per 100	Other Qty	Price	1m	100m	Other Lgth	Price	
10949	1 Channel Wall Transmitter White	54.93									A
10950	2+1 Channel Wall Transmitter White	81.27									A
10951	5+1 Channel Wall Transmitter White	81.27									A
11116	Smart Fix Bracket Cover with Magnet in Silver and White	5.74	54.71	521.01							A
11116	Smart Fix Bracket Cover with Magnet in Antique Bronze, Anodic Grey, Black, Bronze, Charcoal, Ecu, Gunmetal, Slate Grey, Sand, Ochre, Taupe, Matt White	6.77	64.46	613.90							A
11116	Smart Fix Bracket Cover with Magnet in Chrome effect	13.27	126.37	1203.57							A
11118	Smart Fix 60mm Bracket in White and Silver (Set equivalent 11200)	4.85	44.62	423.89							A
11118	Smart Fix 60mm Bracket in Anodic Grey, Antique Bronze, Black, Charcoal (Set equivalent 11200)	5.33	49.08	466.28							A
11119	Smart Fix 80mm Bracket in White and Silver (Set equivalent 11201)	5.56	54.24	515.23							A
11119	Smart Fix 80mm Bracket in Anodic Grey, Antique Bronze, Black, Charcoal (Set equivalent 11201)	6.11	59.67	566.75							A
11120	Smart Fix 100mm Bracket in White and Silver (Set equivalent 11202)	5.71	54.94	521.96							A
11120	Smart Fix 100mm Bracket in Anodic Grey, Antique Bronze, Black, Charcoal (Set equivalent 11202)	6.28	60.43	574.16							A
11121	Smart Fix 120mm Bracket in White and Silver (Set equivalent 11203)	9.38	89.24	849.50							A
11121	Smart Fix 120mm Bracket in Anodic Grey, Antique Bronze, Black, Charcoal (Set equivalent 11203)	10.32	98.16	934.45							A
11122	Smart Fix 150mm Bracket in White and Silver (Set equivalent 11204)	9.60	91.21	868.34							A
11122	Smart Fix 150mm Bracket in Anodic Grey, Antique Bronze, Black, Charcoal (Set equivalent 11204)	10.56	100.33	955.17							A
11123	Smart Fix 200mm Bracket in White and Silver (Set equivalent 11205)	10.64	101.02	961.91							A
11123	Smart Fix 200mm Bracket in Anodic Grey, Antique Bronze, Black, Charcoal (Set equivalent 11205)	11.69	111.12	1058.10							A
11124	Smart Fix 60mm Bracket Slotted for Metropole in Silver, Black, White, Matt White, Ecu, Gunmetal, Charcoal, Bronze, Antique Bronze, Anodic Grey, Slate Grey, Ochre, Sand, Taupe (Set equivalent 11206)	6.31	58.56	538.18							A
11124	Smart Fix 60mm Bracket Slotted for Metropole in Chrome effect (Set equivalent 11206)	10.69	104.34	970.55							A
11125	Smart Fix 80mm Bracket Slotted for Metropole in Silver, Black, White, Matt White, Ecu, Gunmetal, Charcoal, Bronze, Antique Bronze, Anodic Grey, Slate Grey, Ochre, Sand, Taupe (Set equivalent 11207)	7.51	69.63	639.84							A
11125	Smart Fix 80mm Bracket Slotted for Metropole in Chrome effect (Set equivalent 11207)	11.35	110.88	1031.22							A
11126	Smart Fix 100mm Bracket Slotted for Metropole in Silver, Black, White, Matt White, Ecu, Gunmetal, Charcoal, Bronze, Antique Bronze, Anodic Grey, Slate Grey, Ochre, Sand, Taupe (Set equivalent 11208)	8.86	81.92	753.02							A
11126	Smart Fix 100mm Bracket Slotted for Metropole in Chrome effect (Set equivalent 11208)	14.41	140.71	1308.84							A
11127	M4 x 10 CSK. Head Screw for 6138P/6141			31.79							A
11128	Smart Fix Adjustable Extension Bracket slotted for Metropole in Silver, Black, White, Matt White, Ecu, Gunmetal, Charcoal, Bronze, Antique Bronze, Anodic Grey, Slate Grey, Ochre, Sand, Taupe (Set equivalent 11209)	11.10	105.74	1007.01							A
11128	Smart Fix Adjustable Extension Bracket slotted for Metropole in Chrome effect (Set equivalent 11209)	23.08	219.81	2093.45							A
11137	Square Smart Fix Bracket Cover with Magnet in Silver and White	6.71	63.89	608.51							A
11137	Square Smart Fix Bracket Cover with Magnet in Antique Bronze, Anodic Grey, Black, Bronze, Charcoal, Ecu, Gunmetal, Slate Grey, Sand, Ochre, Taupe, Matt White	8.52	81.14	772.76							A
11137	Square Smart Fix Bracket Cover with Magnet in Chrome effect	13.45	128.07	1219.72							A
11139	Square Smart Fix 60mm Bracket in White and Silver (Set equivalent 11210)	6.81	64.88	617.94							A
11139	Square Smart Fix 60mm Bracket in Anodic Grey, Antique Bronze, Black, Charcoal (Set equivalent 11210)	9.04	86.09	819.89							A
11140	Square Smart Fix 80mm Bracket in White and Silver (Set equivalent 11211)	7.51	71.53	681.21							A
11140	Square Smart Fix 80mm Bracket in Anodic Grey, Antique Bronze, Black, Charcoal (Set equivalent 11211)	9.96	94.90	903.88							A
11141	Square Smart Fix 100mm Bracket in White and Silver (Set equivalent 11212)	8.22	78.31	745.83							A
11141	Square Smart Fix 100mm Bracket in Anodic Grey, Antique Bronze, Black, Charcoal (Set equivalent 11212)	10.90	103.72	987.89							A
11142	Square Smart Fix 120mm Bracket in White and Silver (Set equivalent 11213)	9.07	86.37	822.57							A
11142	Square Smart Fix 120mm Bracket in Anodic Grey, Antique Bronze, Black, Charcoal (Set equivalent 11213)	11.99	114.20	1087.66							A
11143	Square Smart Fix 150mm Bracket in White and Silver (Set equivalent 11214)	10.21	97.25	926.23							A
11143	Square Smart Fix 150mm Bracket in Anodic Grey, Antique Bronze, Black, Charcoal (Set equivalent 11214)	13.48	128.35	1222.41							A
11144	Square Smart Fix 200mm Bracket in White and Silver (Set equivalent 11215)	11.62	110.68	1054.13							A
11144	Square Smart Fix 200mm Bracket in Anodic Grey, Antique Bronze, Black, Charcoal (Set equivalent 11215)	15.32	145.81	1388.68							A
11145	Square Smart Fix 60mm Bracket Slotted for Metropole in Silver, Black, White, Matt White, Ecu, Gunmetal, Charcoal, Bronze, Antique Bronze, Anodic Grey, Slate Grey, Ochre, Sand, Taupe (Set equivalent 11216)	8.31	79.16	753.91							A
11145	Square Smart Fix 60mm Bracket Slotted for Metropole in Chrome effect (Set equivalent 11216)	14.61	139.10	1324.73							A
11146	Square Smart Fix 80mm Bracket Slotted for Metropole in Silver, Black, White, Matt White, Ecu, Gunmetal, Charcoal, Bronze, Antique Bronze, Anodic Grey, Slate Grey, Ochre, Sand, Taupe (Set equivalent 11217)	8.91	84.81	807.76							A

# Price Index for Rails & Parts

All prices shown  
exclude V.A.T.

Product	Description	Unit Prices				Per Metre Price				Qty
		Each	Per 10	Per 100	Other Qty	Price	1m	100m	Other Lgth	
11146	Square Smart Fix 80mm Bracket Slotted for Metropole in Chrome effect (Set equivalent 11217)	15.14	144.19	1373.19						A
11147	Square Smart Fix 100mm Bracket Slotted for Metropole in Silver, Black, White, Matt White, Ecu, Gunmetal, Charcoal, Bronze, Antique Bronze, Anodic Grey, Slate Grey, Ochre, Sand, Taupe (Set equivalent 11218)	9.74	92.73	883.15						A
11147	Square Smart Fix 100mm Bracket Slotted for Metropole in Chrome effect (Set equivalent 11218)	15.67	149.27	1421.66						A
11154	Universal Smart Fix 120mm in White and Silver	22.59	215.15	2049.02						A
11154	Universal Smart Fix 120mm in Black (Gunmetal, Matt White, Charcoal, Ecu, Bronze, Antique Bronze, Anodic Grey, Slate Grey, Ochre, Sand, Taupe available 1st February 2024)	25.97	247.41	2356.38						A
11155	Universal Smart Fix 150mm in White and Silver	22.96	218.68	2082.68						A
11155	Universal Smart Fix 150mm in Black (Gunmetal, Matt White, Charcoal, Ecu, Bronze, Antique Bronze, Anodic Grey, Slate Grey, Ochre, Sand, Taupe available 1st February 2024)	26.40	251.49	2395.07						A
11156	Universal Smart Fix 200mm in White and Silver	23.47	223.49	2128.45						A
11156	Universal Smart Fix 200mm in Black (Gunmetal, Matt White, Charcoal, Ecu, Bronze, Antique Bronze, Anodic Grey, Slate Grey, Ochre, Sand, Taupe available 1st February 2024)	26.98	257.02	2447.72						A
11190	Rail, white, black and silver in 6 meter lengths					22.87				A
11190	Rail, white, black and silver cut to size					25.16				A
11190	Rail, matt white, anodic grey, antique bronze and charcoal in 6m lengths					40.83				A
11190	Rail, matt white, anodic grey, antique bronze and charcoal cut to size					44.91				A
11200	Smart Fix 60mm Bracket Set in White and Silver (made up of 11118 + 11116)	7.86	74.83	712.70						A
11200	Smart Fix 60mm Bracket Set in Anodic Grey, Antique Bronze, Black, Charcoal, Matt White (made up of 11119 + 11116)	10.32	98.36	936.76						A
11201	Smart Fix 80mm Bracket Set in White and Silver (made up of 11119 + 11116)	8.86	84.42	804.05						A
11201	Smart Fix 80mm Bracket Set in Anodic Grey, Antique Bronze, Black, Charcoal, Matt White (made up of 11119 + 11116)	10.77	102.49	976.07						A
11202	Smart Fix 100mm Bracket Set in White and Silver (made up of 11120 + 11116)	8.94	85.13	810.78						A
11202	Smart Fix 100mm Bracket Set in Anodic Grey, Antique Bronze, Black, Charcoal, Matt White (made up of 11120 + 11116)	11.63	110.74	1054.68						A
11203	Smart Fix 120mm Bracket Set in White and Silver (made up of 11121 + 11116)	13.65	130.03	1238.34						A
11203	Smart Fix 120mm Bracket Set in Anodic Grey, Antique Bronze, Black, Charcoal, Matt White (made up of 11121 + 11116)	15.01	143.03	1362.17						A
11204	Smart Fix 150mm Bracket Set in White and Silver (made up of 11122 + 11116)	13.86	132.00	1257.19						A
11204	Smart Fix 150mm Bracket Set in Anodic Grey, Antique Bronze, Black, Charcoal, Matt White (made up of 11122 + 11116)	15.25	145.21	1382.91						A
11205	Smart Fix 200mm Bracket Set in White and Silver (made up of 11123 + 11116)	14.89	141.83	1350.75						A
11205	Smart Fix 200mm Bracket Set in Anodic Grey, Antique Bronze, Black, Charcoal, Matt White (made up of 11123 + 11116)	16.38	156.01	1485.83						A
11206	Smart Fix 60mm Bracket Slotted for Metropole Bracket Set in Black, Silver, White, Matt White, Ecu, Gunmetal, Charcoal, Bronze, Antique Bronze, Anodic Grey, Slate Grey, Ochre, Sand, Taupe (made up of 11124 + 11116)	9.12	86.83	827.00						A
11206	Smart Fix 60mm Bracket Slotted for Metropole Bracket Set in Chrome effect (made up of 11124 + 11116)	16.72	159.22	1516.37						A
11207	Smart Fix 80mm Bracket Slotted for Metropole Bracket Set in Black, Silver, White, Matt White, Ecu, Gunmetal, Charcoal, Bronze, Antique Bronze, Anodic Grey, Slate Grey, Ochre, Sand, Taupe (made up of 11125 + 11116)	10.24	97.51	928.66						A
11207	Smart Fix 80mm Bracket Slotted for Metropole Bracket Set in Chrome effect (made up of 11125 + 11116)	17.39	165.59	1577.03						A
11208	Smart Fix 100mm Bracket Slotted for Metropole Bracket Set in Black, Silver, White, Matt White, Ecu, Gunmetal, Charcoal, Bronze, Antique Bronze, Anodic Grey, Slate Grey, Ochre, Sand, Taupe (made up of 11126 + 11116)	11.49	109.39	1041.84						A
11208	Smart Fix 100mm Bracket Slotted for Metropole Bracket Set in Chrome effect (made up of 11126 + 11116)	20.45	194.74	1854.66						A
11209	Smart Fix Adjustable Metropole Bracket Set in Black, Silver, White, Matt White, Ecu, Gunmetal, Charcoal, Bronze, Antique Bronze, Anodic Grey, Slate Grey, Ochre, Sand, Taupe (made up of 11128 + 11116)	14.29	136.06	1295.82						A
11209	Smart Fix Adjustable Metropole Bracket Set in Chrome effect (made up of 11128 + 11116)	29.10	277.14	2639.40						A
11210	Square Smart Fix 60mm Bracket Set in White and Silver (made up of 11139 + 11137)	13.51	128.64	1225.11						A
11210	Square Smart Fix 60mm Bracket Set in Anodic Grey, Antique Bronze, Black, Charcoal, Matt White (made up of 11139 + 11137)	17.56	167.23	1592.64						A
11211	Square Smart Fix 80mm Bracket Set in White and Silver (made up of 11140 + 11137)	14.22	135.42	1289.73						A
11211	Square Smart Fix 80mm Bracket Set in Anodic Grey, Antique Bronze, Black, Charcoal, Matt White (made up of 11140 + 11137)	18.47	176.04	1676.63						A
11212	Square Smart Fix 100mm Bracket Set in White and Silver (made up of 11141 + 11137)	14.93	142.21	1354.35						A



# Price Index for Rails & Parts

All prices shown  
exclude V.A.T.

Product	Description	Unit Prices					Per Metre Price				Qty
		Each	Per 10	Per 100	Other Qty	Price	1m	100m	Other Lgth	Price	
11212	Square Smart Fix 100mm Bracket Set in Anodic Grey, Antique Bronze, Black, Charcoal, Matt White (made up of 11141 + 11137)	19.41	184.86	1760.65							A
11213	Square Smart Fix 120mm Bracket Set in White and Silver (made up of 11142 + 11137)	15.78	150.26	1431.08							A
11213	Square Smart Fix 120mm Bracket Set in Anodic Grey, Antique Bronze, Black, Charcoal, Matt White (made up of 11142 + 11137)	20.50	195.34	1860.42							A
11214	Square Smart Fix 150mm Bracket Set in White and Silver (made up of 11143 + 11137)	16.92	161.15	1534.75							A
11214	Square Smart Fix 150mm Bracket Set in Anodic Grey, Antique Bronze, Black, Charcoal, Matt White (made up of 11143 + 11137)	22.00	209.49	1995.17							A
11215	Square Smart Fix 200mm Bracket Set in White and Silver (made up of 11144 + 11137)	18.33	174.58	1662.64							A
11215	Square Smart Fix 200mm Bracket Set in Anodic Grey, Antique Bronze, Black, Charcoal, Matt White (made up of 11144 + 11137)	23.83	226.95	2161.44							A
11216	Square Smart Fix 60mm Bracket Slotted for Metropole Bracket Set in Silver and White (made up of 11145 + 11137)	15.02	143.05	1362.42							A
11216	Square Smart Fix 60mm Bracket Slotted for Metropole Bracket Set in Black, Matt White, Ecu, Gunmetal, Charcoal, Bronze, Antique Bronze, Anodic Grey, Slate Grey, Ochre, Sand, Taupe (made up of 11145 + 11137)	16.83	160.30	1526.67							A
11216	Square Smart Fix 60mm Bracket Slotted for Metropole Bracket Set in Chrome effect (made up of 11145 + 11137)	28.05	267.17	2544.45							A
11217	Square Smart Fix 80mm Bracket Slotted for Metropole Bracket Set in Silver and White (made up of 11146 + 11137)	15.61	148.71	1416.28							A
11217	Square Smart Fix 80mm Bracket Slotted for Metropole Bracket Set in Black, Matt White, Ecu, Gunmetal, Charcoal, Bronze, Antique Bronze, Anodic Grey, Slate Grey, Ochre, Sand, Taupe (made up of 11146 + 11137)	17.43	165.95	1580.52							A
11217	Square Smart Fix 80mm Bracket Slotted for Metropole Bracket Set in Chrome effect (made up of 11146 + 11137)	28.59	272.26	2592.92							A
11218	Square Smart Fix 100mm Bracket Slotted for Metropole Bracket Set in Silver and White (made up of 11147 + 11137)	16.45	156.63	1491.67							A
11218	Square Smart Fix 100mm Bracket Slotted for Metropole Bracket Set in Black, Matt White, Ecu, Gunmetal, Charcoal, Bronze, Antique Bronze, Anodic Grey, Slate Grey, Ochre, Sand, Taupe (made up of 11147 + 11137)	18.26	173.87	1655.91							A
11218	Square Smart Fix 100mm Bracket Slotted for Metropole Bracket Set in Chrome effect (made up of 11147 + 11137)	29.12	277.35	2641.38							A
11230	Recess profile white, black for 6870 and 3870, in 6 meter lengths					22.27					A
11230	Recess profile white, black for 6870 and 3870, cut to size					24.50					A
11231	Recess profile, white, black for 6465, in 6 meter lengths					16.05					A
11231	Recess profile, white, black for 6465, cut to size					17.65					A
11233	Endcover with screw, white, black silver for 6870	8.17	77.82	741.10							A
11233	Endcover with screw, matt white, anodic grey, antique bronze and charcoal	9.69	92.23	878.34							A
11235	Endcover with screw white, black or silver for 6970	11.01	104.85	998.59							A
11236	Clip			330.87							A
11237	Recess Wedge, white, black	0.76									A
11238	Recess Mask, white, black for 3870 and 6870	3.97									A
11239	Recess Mask, white, black	2.03									A
11260	Gateway	967.22									C
11261	Gateway KNX	1163.28									C
11262	Expansion unit	941.08									C
11263	Power supply 24V DC 2 ampere DIN rail	90.04									C
11264	Power supply 24V DC 3.8 ampere DIN rail	109.94									C
11265	Power supply 24V DC 5 ampere DIN rail	116.37									C
11266	Power supply 24V DC 10 ampere DIN rail	214.62									C
11270	SMART module set white	254.88									C
11270	SMART module set black	305.86									C
11281	Cabinet up to 8 shading device unit including circuit breaker protection	2918.38									C
11282	Cabinet up to 24 shading device unit including circuit breaker protection	3763.43									C
11283	Cabinet up to 56 shading device unit including circuit breaker protection	7133.82									C
11285	Guide set white, black and silver for 3870	35.83	341.14								A
11285	Guide set matt white, anodic grey, antique bronze and charcoal	47.85	455.77								A
11289	Cable with plug	44.27									C
11295	Endstop, silver	0.91	8.61								A
11295	Endstop, white	1.16	11.00								A
11295	Endstop, black	1.31	12.44								A
11301	2C glider in strip form, white, black				1000.00	332.52					A
11302	Wave 2C glider-cord, 80mm pitch, white, black 50mm rolls only						50m	841.46			A
11303	Wave 2C glider-cord, 60mm pitch, white, black 50mm rolls only						50m	1105.29			A
11314	Master carrier for 3970	14.94	142.34								C
11315	Guide set white for 3970	62.70									C
11318	4-Pin connector for 5600 SMART module	12.16									C
11319	4-Pin connector for 5600 SMART motor (Room / control side)	12.16									C
11320	4-Pin connector for 5600 SMART motor (Motor side)	18.23									C
11325	6 - Pin connector for Gateway and Expansion unit	16.07									C
11326	Antenna Cable 40-Series	2.88									C
11327	Dry Contact Cable 40-Series / 50 Series	5.68									C
11335	Endstop, silver	1.27		115.01							A
11335	Endstop, black	1.52		138.32							A
11335	Endstop, white	1.38		125.63							A
11411	Radio module set, white, grey (compatible with 0450)	221.99									C
11411	Radio module set, black (compatible with 0450)	266.38									C

# Price Index for Rails & Parts

All prices shown  
exclude V.A.T.

Product	Description	Unit Prices				Per Metre Price				Qty
		Each	Per 10	Per 100	Other Qty	Price	1m	100m	Other Lgth	
11412	Power supply 24V DC	78.15								C
11425	Power supply set 24v DC UL, 4.0A for 2950	166.81								C
11429	Timer White	160.30								A
11465	Spring Stop for SG 6970	2.72								C
11472	Square Smart Fix Adjustable Metropole Bracket Set in White or Silver (made up of 11483 + 11137)	16.27	155.05	1476.55						A
11472	Square Smart Fix Adjustable Metropole Bracket Set in Black, Matt White, Ecrú, Gunmetal, Charcoal, Bronze, Antique Bronze, Anodic Grey, Slate Grey, Ochre, Sand, Taupe (made up of 11483 + 11137)	18.09	172.30	1640.80						A
11472	Square Smart Fix Adjustable Metropole Bracket Set in Chrome effect (made up of 11483 + 11137)	36.15	344.58	3281.60						A
11480	1 Channel Wall Switch	148.40								C
11483	Square Smart Fix Adjustable Extension Bracket slotted for Metropole in Silver, Black, White, Matt White, Ecrú, Gunmetal, Charcoal, Bronze, Antique Bronze, Anodic Grey, Slate Grey, Ochre, Sand, Taupe (Set equivalent 11472)	9.57	91.16	868.04						A
11483	Square Smart Fix Adjustable Extension Bracket slotted for Metropole in Chrome effect (Set equivalent 11472)	22.70	216.51	2061.88						A
11490	5 Channel Wall Switch	272.20								C
11601	Flush Endcap, 36mm, Silver, Black, White, Matt White, Gunmetal, Chrome effect, Antique bronze, Slate Grey, Charcoal, Anodic Grey, Bronze	10.66	104.58							A
11602	Flush Endcap, 23mm, Silver, Black, Charcoal, Ecrú, White, Matt White Gunmetal, Chrome effect	12.32	120.39							A
11603	Flush Endcap, 30mm, Silver, Black, Gunmetal, White, Matt White, Charcoal, Ecrú, Bronze, Antique Bronze, Anodic Grey, Slate Grey, Ochre, Sand, Taupe, Chrome effect	10.51	99.71							A
11605	Flush Endcap, 50mm, Silver, White, Matt White, Ecrú, Black	32.74	320.88							A
11605	Flush Endcap, 50mm, Antique Bronze, Anodic Grey, Slate Grey, Taupe, Bronze	33.55	328.73							A
11606	Rail, 23mm, Silver, Black, White, Matt White, Ecrú in 6 metre lengths only					26.32				A
11606	Rail, 23mm, Gunmetal, Charcoal in 6 metre lengths only Chrome effect (Chrome effect 4 metre lengths only)					36.00				A
11607	Corded profile, 50mm, Black, Ecrú, White, Matt White					92.64				A
11607	Corded profile, 50mm, Antique Bronze, Bronze, Anodic Grey, Slate Grey, Taupe, Bronze					107.38				A
11609	Profile, 50mm, for 7620 Black, Ecrú, Silver, White, Matt White					58.60				A
11609	Profile, 50mm, for 7620 Antique Bronze, Anodic Grey, Slate Grey, Taupe					79.43				A
11611	Stud endcap for 36mm, Antique Bronze, Anodic Grey, Black, Gunmetal, Charcoal, Silver, Slate Grey, White, Matt White, Chrome effect, Bronze (Avilable from 1st April 2022)	10.66	101.36	960.18						A
11621	Stud endcap for 23mm, Ecrú, Black, Gunmetal, Charcoal, Silver, White, Matt White, Chrome effect	12.32	120.39	1119.86						A
11622	Design End cap for 23mm, White, Black, Matt White, Ecrú, Gunmetal and Charcoal	16.84	160.40							A
11623	Groove cylinder finial only for 23mm, White, Black, Matt White, Ecrú, Gunmetal and Charcoal - set equivalent 11723	28.01	266.64							A
11624	Glass Ball finial only clear for 23mm - set equivalent 11724	63.26	548.05							A
11626	Ball end finial only for 23mm, White, Black, Matt White, Ecrú, Gunmetal and Charcoal - set equivalent 11726	46.01	438.16							A
11627	Spear finial only 23mm, White, Black, Matt White, Ecrú, Gunmetal and Charcoal - set equivalent 11727	29.97	285.39							A
11628	Ellipse finial only 23mm, White, Black, Matt White, Ecrú, Gunmetal and Charcoal - set equivalent 11728	19.48	185.40							A
11629	Taper finial only 23mm, White, Black, Matt White, Ecrú, Gunmetal and Charcoal - set equivalent 11729	12.70	120.82							A
11631	Stud endcap for 30mm, Antique Bronze, Anodic Grey, Black, Bronze, Charcoal, Ecrú, Gunmetal, Slate Grey, Silver, Sand, Ochre, Taupe, White, Matt White, Chrome effect	10.51	99.71	947.32						A
11632	Design end cap for 30mm, Antique Bronze, Anodic Grey, Black, Bronze, Charcoal, Ecrú, Gunmetal, Slate Grey, Sand, Ochre, Taupe, White and Matt White	23.23								A
11633	Groove cylinder finial only for 30mm - set equivalent 11733 Cord, 11743 Hand	34.50	328.44							A
11634	Glass Ball finial only for 30mm, clear - equivalent set 11734 Cord, 11744 Hand	66.95	579.79							A
11636	Ball end finial only 30mm, Black, Gunmetal, White, Matt White, Charcoal, Ecrú, Bronze, Antique Bronze, Anodic Grey, Slate Grey, Ochre, Sand and Taupe 30mm poles - set equivalent 11736 Cord, 11746 Hand	49.81	474.32							A
11637	Spear finial only 30mm, Antique Bronze, Anodic Grey, Black, Bronze, Charcoal, Ecrú, Gunmetal, Slate Grey, Sand, Ochre, Taupe, White, Matt White - set equivalent 11737 Cord, 11747 Hand	48.51								A
11638	Ellipse finial only, 30mm, Black, White, Matt White, Ecrú, Ochre, Gunmetal, Bronze, Antique Bronze, Sand, Taupe, Anodic Grey, Charcoal and Slate Grey - set equivalent 11738 Cord, 11748 Hand	28.23	268.73							A
11639	Taper finial only, 30mm, Black, White, Matt White, Ecrú, Ochre, Gunmetal, Bronze, Antique Bronze, Sand, Taupe, Anodic Grey, Charcoal and Slate Grey - set equivalent 11739 Cord, 11749 Hand	14.44	137.49							A
11651	Stud endcap for 50mm, Black, Ecrú, Silver, White, Matt White	32.74								A
11651	Stud endcap for 50mm, Antique Bronze, Anodic Grey, Slate Grey, Taupe, Bronze (Avilable from 1st April 2022)	33.54								A
11652	Design end cap for 50mm, (Hand, Cord, Electric) Antique Bronze, Anodic Grey, Black, Bronze, Ecrú, Silver, Slate Grey, Taupe, White and Matt White	32.96	313.86							A
11653	Groove cylinder finial only for 50mm - set equivalent 11753 for Cord, 11773 for Hand, or 11763 for Electric	75.17	715.91							A
11654	Glass Ball finial only, 50mm, Clear - set equivalent 11754 for Cord, 11774 for Hand or 11764 for Electric	126.97	1099.81							A

# Price Index for Rails & Parts

All prices shown  
exclude V.A.T.

Product	Description	Unit Prices				Per Metre Price				Qty
		Each	Per 10	Per 100	Other Qty	Price	1m	100m	Other Lgth	
11656	Ball end finial only for 50mm, Antique Bronze, Anodic Grey, Black, Ecu, Slate Grey, Taupe, White and Matt White - set equivalent 11756 for Cord, 11776 for Hand or 11766 for Electric	98.82	941.28							A
11657	Spear finial only for 50mm, Antique Bronze, Anodic Grey, Black, Ecu, Slate Grey, Taupe, White and Matt White - set equivalent 11757 for Cord, 11777 for Hand or 11767 for Electric	147.21	1401.96							A
11658	Ellipse finial only for 50mm, Black, White, Matt White, Ecu, Taupe, Antique Bronze, Anodic Grey and Slate Grey - set equivalent 11758 for Cord, 11778 for Hand or 11768 for Electric	118.18	1125.60							A
11659	Taper finial only for 50mm, Black, White, Matt White, Ecu, Taupe, Antique Bronze, Anodic Grey and Slate Grey - set equivalent 11759 for Cord, 11779 for Hand or 11769 for Electric	77.57	738.83							A
11661	Cording Set without endcap for 30mm, Black, Gunmetal, White, Matt White, Charcoal, Ecu, Bronze, Antique Bronze, Anodic Grey, Slate Grey, Ochre, Sand, Taupe and Chrome effect	61.15	573.21							A
11662	Cording Set without endcap for 50mm, Black, White, Matt White, Ecu, Antique Bronze, Anodic Grey, Slate Grey, Taupe, Bronze	72.83	691.92							A
11663	Intermediate Pulley for 30mm, Antique Bronze, Anodic Grey, Black, Bronze, Charcoal, Ecu, Gunmetal, Slate Grey, Sand, Ochre, Taupe, White, Matt White, Chrome effect	83.34	833.45							A
11664	Intermediate pulley set for 50mm, White, Black, Ecu, Matt White	85.49								A
11664	Intermediate pulley set for 50mm, Taupe, Antique Bronze, Anodic Grey, Slate Grey, Bronze	94.66								A
11665	Finial connector for 23mm	2.77	26.39							A
11666	Finial connector for 30mm Cord	3.12	29.86							A
11667	Finial connector for 50mm Cord	5.83	55.55							A
11668	Top Fix Bracket, Silver, Black, Gunmetal, White, Matt White, Charcoal, Ecu, Bronze, Antique Bronze, Anodic Grey, Slate Grey, Ochre, Sand, Taupe	22.68	194.43							A
11669	Fillet Bracket, White, Silver Black, Antique Bronze, Anodic Grey, Bronze, Charcoal, Ecu, Gunmetal, Matt White, Ochre, Slate Grey, Sand, Taupe, Chrome effect	50.44	480.39							A
11700	Finial connector for 30mm Hand	3.12	29.86							A
11701	Finial Connector for 50mm Electric	5.83	55.55							A
11716	Wave single stack return pulley 30mm	34.85	331.50							
11723	Groove cylinder finial set for 23mm, White, Black, Matt White, Ecu, Gunmetal and Charcoal - made up of 11623 + 11665	30.77	293.03							A
11724	Glass Ball finial set 23mm, clear - made up of 11624 + 11665	66.03	574.44							A
11726	Ball end finial set 23mm, White, Black, Matt White, Ecu, Gunmetal and Charcoal - made up of 11626 and 11665	48.78	464.54							A
11727	Spear finial set 23mm, White, Black, Matt White, Ecu, Gunmetal and Charcoal - made up of 11627 + 11665	32.74	311.78							
11728	Ellipse finial set 23mm, White, Black, Matt White, Ecu, Gunmetal and Charcoal - made up of 11628 + 11665	22.24	211.79							A
11729	Taper finial set 23mm, White, Black, Matt White, Ecu, Gunmetal and Charcoal - made up of 11629 + 11665	15.46	147.21							A
11733	Groove Cylinder finial set for 30mm Cord, made up of 11633 + 11666	37.62	358.30							A
11734	Glass Ball finial clear set for 30mm Cord - made up of 11634 + 11666	70.07	609.65							A
11736	Ball End finial set, 30mm Cord Black, Gunmetal, White, Matt White, Charcoal, Ecu, Bronze, Antique Bronze, Anodic Grey, Slate Grey, Ochre, Sand and Taupe - made up of 11636 + 11666 (30mm Cord)	52.94	504.18							A
11737	Spear finial set, 30mm Cord, Antique Bronze, Anodic Grey, Black, Bronze, Charcoal, Ecu, Gunmetal, Slate Grey, Sand, Ochre, Taupe, White, Matt White, Chrome effect - made up of 11637 + 11666	51.64								A
11738	Ellipse finial set for 30mm Cord, Black, White, Matt White, Ecu, Ochre, Gunmetal, Bronze, Antique Bronze, Sand, Taupe, Anodic Grey, Charcoal and Slate Grey - made up of 11638 + 11666	31.35	298.59							A
11739	Taper finial set for 30mm Cord, Black, White, Matt White, Ecu, Ochre, Gunmetal, Bronze, Antique Bronze, Sand, Taupe, Anodic Grey, Charcoal and Slate Grey - made up of 11639 + 11666	17.57	167.35							A
11743	Groove Cylinder finial set for 30mm Hand, made up of 11633 + 11700	37.62	358.30							A
11744	Glass Ball finial clear set for 30mm Hand - made up of 11634 + 11700	70.07	609.65							A
11746	Ball End finial set, 30mm Hand, Black, Gunmetal, White, Matt White, Charcoal, Ecu, Bronze, Antique Bronze, Anodic Grey, Slate Grey, Ochre, Sand and Taupe - made up of 11636 + 11700 (30mm Hand)	52.94	504.18							A
11747	Spear finial set, 30mm Hand, Antique Bronze, Anodic Grey, Black, Bronze, Charcoal, Ecu, Gunmetal, Slate Grey, Sand, Ochre, Taupe, White and Matt White - made up of 11637 + 11700	51.64								A
11748	Ellipse finial set for 30mm Hand, Black, White, Matt White, Ecu, Ochre, Gunmetal, Bronze, Antique Bronze, Sand, Taupe, Anodic Grey, Charcoal and Slate Grey - made up of 11638 + 11700	31.35	298.59							A
11749	Taper finial set for 30mm Hand, Black, White, Matt White, Ecu, Ochre, Gunmetal, Bronze, Antique Bronze, Sand, Taupe, Anodic Grey, Charcoal and Slate Grey - made up of 11639 + 11700	17.57	167.35							A
11753	Groove cylinder finial set for 50mm Cord - made up of 11653 + 11667	81.00	771.46							A
11754	Glass Ball finial set Clear for 50mm Cord - made up of 11654 + 11667	132.80	1155.36							A
11756	Ball end finial set for 50mm Cord, Antique Bronze, Anodic Grey, Black, Ecu, Slate Grey, Taupe, White, Matt White - made up of 11656 + 11667	104.65	996.85							A
11757	Spear finial set for 50mm Cord, Antique Bronze, Anodic Grey, Black, Ecu, Slate Grey, Taupe, White and Matt White - made up of 11657 + 11667	153.04	1457.51							A
11758	Ellipse finial set for 50mm Cord, Black, White, Matt White, Ecu, Taupe, Antique Bronze, Anodic Grey and Slate Grey - made up of 11658 + 11667	124.02	1181.15							A

# Price Index for Rails & Parts

All prices shown  
exclude V.A.T.

Product	Description	Unit Prices					Per Metre Price				Qty
		Each	Per 10	Per 100	Other Qty	Price	1m	100m	Other Lgth	Price	
11759	Taper finial set for 50mm Cord, Black, White, Matt White, Ecu, Taupe, Antique Bronze, Anodic Grey and Slate Grey - made up of 11659 + 11667	83.41	794.38								A
11763	Groove cylinder finial set for 50mm Electric - made up of 11653 + 11701	81.00	771.57								A
11764	Glass Ball finial set, 50mm (Electric), clear - made up of 11654 + 11701	132.80	1155.36								A
11766	Ball End finial set, 50mm (Electric) Antique Bronze, Bronze, Anodic Grey, Black, Ecu, Slate Grey, Taupe, White and Matt White - made up of 11656 + 11701	104.65	996.85								A
11767	Spear finial set, 50mm (Electric) Antique Bronze, Bronze, Anodic Grey, Black, Ecu, Slate Grey, Taupe, White and Matt White - made up of 11657 + 11701	153.04	1457.51								A
11768	Ellipse finial set, 50mm (Electric) Ecu, White, Black, Matt White, Anodic Grey, Slate Grey, Antique Bronze, Bronze and Taupe - made up of 11658 + 11701	124.02	1181.15								A
11769	Taper finial set, 50mm (Electric) Ecu, White, Black, Matt White, Anodic Grey, Slate Grey, Antique Bronze, Bronze and Taupe - made up of 11659 + 11701	83.41	794.38								A
11773	Groove cylinder finial set for 50mm Hand - made up of 11653 + 11782	81.00	771.46								A
11774	Glass Ball Finial Clear set for 50mm Hand - made up of 11654 + 11782	132.80	1155.36								A
11776	Ball end finial set for 50mm Hand, Antique Bronze, Anodic Grey, Black, Ecu, Slate Grey, Taupe, White and Matt White - made up of 11656 + 11782	104.65	996.85								A
11777	Spear finial set for 50mm Hand, Antique Bronze, Anodic Grey, Black, Ecu, Slate Grey, Taupe, White, Matt White - made up of 11657 + 11782	153.04	1457.51								A
11778	Ellipse finial set for 50mm Hand, Black, White, Matt White, Ecu, Taupe, Antique Bronze, Anodic Grey and Slate Grey - made up of 11658 + 11782	124.02	1181.15								A
11779	Taper finial set for 50mm Hand, Black, White, Matt White, Ecu, Taupe, Antique Bronze, Anodic Grey and Slate Grey - made up of 11659 + 11782	83.41	794.38								A
11782	Finial connector for 50mm Hand	5.83	55.55								A
11783	Connecting Bridge for 50mm Hand, Antique Bronze, Bronze, Anodic Grey, Black, Ecu, Silver, Slate Grey, Taupe, White, Matt White	35.62									A
20336	Eight channel hand held remote	235.27									C
20907	Control module for 24v dc switched motors	415.52									C
20913	Single-channel wall switch, antique brass, black nickle, chocolate bronze, matt black, matt white, polished brass, brushed silver, mirror finish	318.70									C
20914	Eight-channel wall switch, antique brass, black nickle, chocolate bronze, matt black, matt white, polished brass, brushed silver, mirror finish	318.70									C
20917	White pattress box	26.91									C
20919	Control Module for mains switched motors	384.89									C

# Tools & Packaging

All prices shown  
exclude V.A.T.

Product	Description	Unit Prices				Per Metre Price				Qty
		Each	Per 10	Per 100	Other Qty	Price	1m	100m	Other Lgth	
0388	Action Motor Setting Tool	37.35								E
538	Bending Kit for 7103/7109 incl fillers, blocks, arms and rings for system 3840	309.39								E
539	Crimping tool	401.46								E
547	Bending block set (6103)	501.61								E
0587	2.5mm Allen Key for Metropole	0.12								E
0600	Connector tongs for metal chain	78.42								E
679	Joining pliers for bead chain 4845	160.87								E
0722	2mm Allen Key	0.66								E
6827	Funnel Fixing Tool	6.67								E
7004	Cording needle	2.37								E
7037	Bending fillers 6100	100.74								E
7103	Portable hand operated bending tool for 1080, 1280, 3000, 3840/6840 and 3900 complete with sets of fillers	1854.07								E
7109	Portable electrically operated bending tool for 1080, 3000, 3840/6840 1280 and 3900 complete with sets of fillers	1981.75								E
7223	Tongs for connector 2865	739.27								E
7230	Slotting tool for wide channel profiles	252.87								E
7244	Notching tool for 6465 recess profile	76.14								E
7245	Notching tool for 3870/6870 recess profile	76.14								E
7246	Notching tool for 3970/6970/5600 recess profile	76.14								E
7404	Former for 7103/7109 radius 15cm	121.58								E
7432	Bending ring 15cm 1003 for 7103/9	81.91								E
7439	Blocks for 7103/7109 for 6010 profile, 2 required	51.25								E
7550	Centre tool	106.22								E
7802	Filler set 3840 for 7103/9, 200 cm	193.99								E
7803A	Filler set 3900 for 7103/9, 70 cm	113.94								E
7805	Filler set 3000 for 7103/9, 200 cm	344.99								E
7805A	Filler set 3000 for 7103/9, 70 cm	179.08								E
7806	Filler set 1080 for 7103/9, 200 cm	99.18								E
7806A	Filler set 1080 for 7103/9, 70 cm	48.29								E
7830	Filler set 3900 for 7103/9, 200 cm	282.87								E
7844	Filler set 1280 for 7103/9, 70cm	152.50								E
7844A	Filler set 1280 for 7103/9, 200cm	280.81								E
7848	Filler set 1003 for 7103/9, 70cm	55.68								E
7885	Filler set 6010 for 7103/7109, 200cm	220.00								E
10482	Child Safety Device (4mm metal to metal bead chain)	12.49								E
10537	Joining pliers for 10530 chain (4910)	140.40								E
11269	Hand held setting tool for Series 40 and SMART motors (TTPRO)	130.71								E
11422	230v Setting Lead	39.21								E
80018	Slotting tool	586.19								E
B5	Bending block for 6100	547.81								E
SF	Silicone fluid, 400ml	27.99								E
Labour	To fully assemble cabinet with SMART Gateway, expansion unit (if required) and power supplies:									
	Up to 8 systems (Labour cost only)	226.60								E
	Up to 24 systems (Labour cost only)	226.60								E
	Up to 56 systems (Labour cost only)	226.60								E

## Application Chart for Silent Gliss® Switches, Remote Control and Multiple Operation of Motorised Systems

	Fixed Switch (Hard Wired)	Radio Control Systems 0450			Radio Control Systems 9940		*SMART	System
		Hand Held Remotes/Receiver	Wall Switched	Move Server Unit	Hand Held Remote/Receiver	Wall Switches & Light Sensors	Via Gateway	
	Motor 2160 0615/6/7/8/9 Latching	Remote 20336 Receiver 20919	Wall Switch 20913/ 20914 Receiver 20919	✓	Remote 10300/10302/ 10303/10804 Receiver 9068/9945	Wall Switch 11480 Receiver 9068/9945	n/a	2195
	Motor 10522/10322 0615/6/7/8/9 Latching	Motor 10322/10522 Remote 20336 Receiver 20919	Motor 10322/10522 Wall Switch 20913/ 20914 Receiver 20919	✓	Motor 11241/11244 Remote 10300/10302/ 10303/10804 Receiver Integrated	Motor 11241/11244 Wall Switch 11480/11490 Receiver Integrated	11251	2350
	Motor 9090 0613 5 Position	Motor 9091 Remote 20336 Receiver Intergrated	Motor 9091 Wall Switch 20913/ 20914 Receiver Intergrated	✓	Motor 9091EL Remote 10300/10302/ 10303/10804 Receiver Integrated	Motor 9091EL Wall Switch 11480/11490 Receiver Integrated	n/a	2950
	Motor 10522 0615/6/7/8/9 Latching	Motor 10522 Remote 20336 Receiver 20919	Motor 10522 Wall Switch 20913/ 20914 Receiver 20919	✓	Motor 11241/11244 Remote 10300/10302/ 10303/10804 Receiver Integrated	Motor 11241/11244 Wall Switch 11480/11490 Receiver Integrated	11251	4760
	Motor 10522 0615/6/7/8/9 Latching	Motor 10522 Remote 20336 Receiver 20919	Motor 10522 Wall Switch 20913/ 20914 Receiver 20919	✓	Motor 11241/11244 Remote 10300/10302/ 10303/10804 Receiver Integrated	Motor 11241/11244 Wall Switch 11480/11490 Receiver Integrated	11251	4770
	Motor 10522 0615/6/7/8/9 Latching	Motor 10522 Remote 20336 Receiver 20919	Motor 10522 Wall Switch 20913/ 20914 Receiver 20919	✓	Motor 11241/11244 Remote 10300/10302/ 10303/10804 Receiver Integrated	Motor 11241/11244 Wall Switch 11480/11490 Receiver Integrated	11251	4780
	10692 (0631)	n/a	n/a	n/a	n/a	n/a	n/a	4960
	Motor 10320 0615/6/7/8/9 Latching	Motor 10320 Remote 20336 Receiver 20919	Motor 10320 Wall Switch 20913/ 20914 Receiver 20919	✓	Motor 11240/11243 Remote 10300/10302/ 10303/10804 Receiver Integrated	Motor 11240/11243 Wall Switch 11480/11490 Receiver Integrated	11250	4960
	Motor 10522 0615/6/7/8/9 Latching	Motor 10522 Remote 20336 Receiver 20919	Motor 10522 Wall Switch 20913/ 20914 Receiver 20919	✓	Motor 11241/11244 Remote 10300/10302/ 10303/10804 Receiver Integrated	Motor 11241/11244 Wall Switch 11480/11490 Receiver Integrated	11251	4970
	Motor 10326 0615/6/7/8/9 Latching	Motor 10326 Remote 20336 Receiver 20919	Motor 10326 Wall Switch 20913/ 20914 Receiver 20919	✓	Motor 11248/11249 Remote 10300/10302/ 10303/10804 Receiver Integrated	Motor 11248/11249 Wall Switch 11480/11490 Receiver Integrated	11255	4880
9060	Motor 9060 0615/6/7/8/9	Motor 9060 Remote 20336 Receiver Module 11411	Motor 9060 Remote 20336 Receiver Module 11411	✓	Motor 9060 Remote 10300/10302/ 10303/10804 Receiver Module 9063	Motor 9060 Wall Switch 11480/11490 Receiver Module 9063	11270	5600
5805	0615/6/7/8/9 Latching	n/a	n/a	✓	Remote 10300/10302/ 10303/10804 Receiver Module 9068	Wall Switch 11480 Receiver 9068	n/a	5800
8060	0928 5 Position	Motor 8060 Remote 20336 Receiver 20907 (Pulse Enabled)	Wall Switch 20913/20914 Receiver 20907 (Pulse Enabled)	✓	Remote 10300/10302/ 10303/10804 Receiver Module 9068/9947	Wall Switch 11480 Receiver 9068/9947	n/a	8250

\*Refer to page 28 for SMART components



## Application Chart for Silent Gliss® Switches, Remote Control and Multiple Operation of Motorised Systems

Motor Number	Fixed Switch (Hard Wired)	Radio Control Systems 0450		Radio Control Systems 9940			*SMART	System
		Hand Held Remotes	Wall Switched	Move Server Unit	Hand Held Remote	Wall Switches & Light Sensors	Via Gateway	
		Wall Switch 20913/20914 Receiver 20907	Wall Switch 20913/20914 Receiver 20907	✓	Remote 10300/10302/ 10303/10804 Receiver 9068/9947	Wall Switch 11480/11490 Receiver 9068/9947	n/a	8500
8605	0615/6/7/8/9 Latching	Wall Switch 20913/20914 Receiver 20919	Wall Switch 20913/20914 Receiver 20919	✓	Remote 10300/10302/ 10303/10804 Receiver 9068/9945	Wall Switch 11480/11490 Receiver 9068/9945	n/a	8600
	0615/6/7/8/9 Latching	Wall Switch 20913/20914 Receiver 20919	Wall Switch 20913/20914 Receiver 20919	✓	Remote 10300/10302/ 10303/10804 Receiver 9068/9945	Wall Switch 11480/11490 Receiver 9068	n/a	8640
11096	0613 5 Position	Wall Switch 20913/20914 Receiver Integrated	Wall Switch 20913/20914 Receiver Integrated	✓	Remote 10300/10302/ 10303/10804 Receiver Integrated	Wall Switch 11480/11490 Receiver Integrated	n/a	8960

## Battery Operated Blinds Application Chart for Remote Control Switches and Wall Plates

Motor	Hand Wired Switch	Wall Plates	Hand Held Remote	Move Server Unit	9940	0450	SMART	Timer and Control	System
11076	n/a	10949, 10950, 10951	10946, 10947, 10948	n/a	n/a	n/a	n/a	11429	4955
11076	n/a	10949, 10950, 10951	10946, 10947, 10948	n/a	n/a	n/a	n/a		2345
5190	n/a	10949	10946, 10947, 10948	n/a	n/a	n/a	n/a		5100B
5190	n/a	10949, 10950	10946, 10947, 10948	n/a	n/a	n/a	n/a		5100R
5190	n/a	10949, 10950	10946, 10947, 10948	n/a	n/a	n/a	n/a	11429	5100T
5190	n/a	10949, 10950, 10951	10946, 10947, 10948	n/a	n/a	n/a	n/a	11429	5100TC



For motor types and connections see wiring diagrams.

# Terms & Conditions of Trading with Silent Gliss Ltd

The buyer's attention is in particular drawn to the provisions of condition 12.4.

## 1. INTERPRETATION

- 1.1 The definitions and rules of interpretation in this condition apply in these conditions.  
**Buyer:** the person, firm or company who purchases the Goods and/or Services from the Company.  
**Company:** Silent Gliss Ltd.  
**Contract:** any contract between the Company and the Buyer for the sale and purchase of the Goods and/or provision of Services, incorporating these conditions.  
**Delivery Point:** the place where delivery of the Goods is to take place under condition 4.  
**Goods:** any goods agreed in the Contract to be supplied to the Buyer by the Company (including any part or parts of them).  
**Services:** any installation services agreed in the Contract to be supplied to the Buyer by the Company.
- 1.2 A reference to a particular law is a reference to it as it is in force for the time being taking account of any amendment, extension, application or re-enactment and includes any subordinate legislation for the time being in force made under it.
- 1.3 Words in the singular include the plural and in the plural include the singular.
- 1.4 A reference to one gender includes a reference to the other gender.
- 1.5 Condition headings do not affect the interpretation of these conditions.

## 2. APPLICATION OF TERMS

- 2.1 Subject to any variation under condition 2.3 the Contract shall be on these conditions to the exclusion of all other terms and conditions (including any terms or conditions which the Buyer purports to apply under any purchase order, confirmation of order, specification or other document).
- 2.2 No terms or conditions endorsed on, delivered with or contained in the Buyer's purchase order, confirmation of order, specification or other document shall form part of the Contract simply as a result of such document being referred to in the Contract.
- 2.3 These conditions apply to all the Company's sales and any variation to these conditions and any representations about the Goods and/or Services shall have no effect unless expressly agreed in writing and signed by the Sales Director of the Company. The Buyer acknowledges that it has not relied on any statement, promise or representation made or given by or on behalf of the Company which is not set out in the Contract. Nothing in this condition shall exclude or limit the Company's liability for fraudulent misrepresentation.
- 2.4 Each order or acceptance of a quotation for Goods and/or Services from the Company shall be deemed to be an offer by the Buyer to buy Goods and/or Services subject to these conditions.
- 2.5 No order placed by the Buyer shall be deemed to be accepted by the Company until a written acknowledgement of order is issued by the Company or (if earlier) the Company delivers the Goods to and/or carries out the Services for the Buyer.
- 2.6 The Buyer shall ensure that the terms of its order and any applicable specification are complete and accurate.
- 2.7 Any quotation is given on the basis that no Contract shall come into existence until the Company despatches an acknowledgement of order to the Buyer. Any quotation is valid for a period of 60 days only from its date, provided that the Company has not previously withdrawn it.

## 3. DESCRIPTION

- 3.1 The quantity and description of the Goods and/or Services shall be as set out in the Company's quotation or acknowledgement of order.
- 3.2 All samples, drawings, descriptive matter, specifications and advertising issued by the Company and any descriptions or illustrations contained in the Company's catalogues or brochures are issued or published for the sole purpose of giving an approximate idea of the Goods described in them. They shall not form part of the Contract and this is not a sale by sample.

## 4. DELIVERY

- 4.1 Unless otherwise agreed in writing by the Company, delivery of the Goods shall take place at the time the Goods have been unloaded at the delivery address nominated by the Buyer.
- 4.2 The Buyer shall take delivery of the Goods within 30 days of the Company giving it notice that the Goods are ready for delivery.

4.3 Any dates specified by the Company for delivery of the Goods or commencement or duration for performance of the Services are intended to be an estimate and time for delivery and/or performance shall not be made of the essence by notice. If no dates are so specified, delivery and/or performance shall be within a reasonable time.

4.4 Subject to the other provisions of these conditions the Company shall not be liable for any direct, indirect or consequential loss (all three of which terms include, without limitation, pure economic loss, loss of profits, loss of business, depletion of goodwill and similar loss), costs, damages, charges or expenses caused directly or indirectly by any delay in the delivery of the Goods or performance of the Services (even if caused by the Company's negligence), nor shall any delay entitle the Buyer to terminate or rescind the Contract unless such delay exceeds 60 days.

4.5 If for any reason the Buyer fails to accept delivery of any of the Goods when they are ready for delivery, or the Company is unable to deliver the Goods on time because the Buyer has not provided appropriate instructions, documents, licences or authorisations:

- (a) risk in the Goods shall pass to the Buyer (including for loss or damage caused by the Company's negligence);
- (b) the Goods shall be deemed to have been delivered; and
- (c) the Company may store the Goods until delivery, whereupon the Buyer shall be liable for all related costs and expenses (including, without limitation, storage and insurance).

4.6 If the Company delivers to the Buyer a quantity of Goods of up to 5% more or less than the quantity accepted by the Company, the Buyer shall not be entitled to object to or reject the Goods or any of them by reason of the surplus or shortfall and shall pay for such goods at the pro rata Contract rate.

4.7 The Company may deliver the Goods by separate instalments. Each separate instalment shall be invoiced and paid for in accordance with the provisions of the Contract.

4.8 Each instalment shall be a separate Contract and no cancellation or termination of any one Contract relating to an instalment shall entitle the Buyer to repudiate or cancel any other Contract or instalment.

## 5. CANCELLATIONS AND RETURNS

The Buyer shall not be entitled to cancel any Contract or return Goods for refund without the prior written consent of the Company (which will be the absolute discretion of the Company) and payment of a handling charge of 20% of the Price in respect of ex stock items and in the case of made-to-measure items a percentage of the Price dependent upon the stage of manufacture reached at the point of cancellation.

## 6. NON-DELIVERY

- 6.1 The quantity of any consignment of Goods as recorded by the Company upon despatch from the Company's place of business shall be conclusive evidence of the quantity received by the Buyer on delivery unless the Buyer can provide conclusive evidence proving the contrary.
- 6.2 The Company shall not be liable for any non-delivery of Goods (even if caused by the Company's negligence) unless the Buyer gives written notice to the Company of the non-delivery within 7 days of the date when the Goods would in the ordinary course of events have been received.
- 6.3 Any liability of the Company for non-delivery of the Goods shall be limited to replacing the Goods within a reasonable time or issuing a credit note at the pro rata Contract rate against any invoice raised for such Goods.

## 7. INSTALLATION

- 7.1 All costs in relation to Installation by the Company shall be payable by the Buyer in addition to the price of the Goods. The following standard charges apply (duration of each installation is dependent on the type of work being carried out):
- £450 + VAT per day (per engineer)
  - £300 + VAT per ½ day (per engineer)
  - £300 + VAT Service Callout (parts not included)
- 7.2 The Buyer shall be solely responsible for ensuring that its site and adequate and safe access thereto is ready for installation of the Goods. Fixing points must be adequate for the proper and secure installation of the Goods. The Buyer must pay for the cost of any modification to its site or the Goods that is required to enable the Goods to be properly installed.

- 7.3 The Buyer shall be solely responsible for all ancillary work required and costs incurred in connection with installation of Goods, including (without limitation) access, scaffolding hire, electrical work, decorating, or making good.
- 7.4 The Buyer shall advise the Company of any hidden obstruction (including without limitation, electricity, telephone and other communications cables and water, gas and drainage pipes) that may be encountered during installation of the Goods. The Company will not be liable for any damage to any structure, surface or service. The Buyer will pay all costs incurred by the Company in consequence of any damage to any hidden obstruction and will indemnify the Company against all liability, loss, cost and expense that it incurs arising out of or in consequence of installation of the Goods or damage to any structure, surface or service.
- 7.5 At all times, suppliers must comply with the Regulations. The Regulations provide that the Suppliers performing the installation services must fit any safety device supplied with the Goods.
- (a) In the event that the Customer should refuse to allow the Supplier to fit any such safety device accompanying the Goods, then the Supplier will be at liberty to refuse to carry out the Services. In such instance, the Customer will still be liable to pay the Supplier the Price in full under the Contract.
  - (b) The Customer shall not be entitled to treat the Suppliers refusal to carry out any Services in relation to the Goods for the reasons set out in this clause 7.4 as a fundamental or any breach of contract. The Customer will still be bound under the Contract to take delivery of the Goods.
- 7.6 The parties to the contract consider the provisions of this clause 7.4 to be reasonable under all the circumstances given the Supplier's obligations under the Regulations.
- 8. RISK/TITLE**
- 8.1 The Goods are at the risk of the Buyer from the time of delivery.
- 8.2 Ownership of the Goods shall not pass to the Buyer until the Company has received in full (in cash or cleared funds) all sums due to it in respect of:
- (a) the Goods; and
  - (b) all other sums which are or which become due to the Company from the Buyer on any account.
- 8.3 Until ownership of the Goods has passed to the Buyer, the Buyer shall:
- (a) hold the Goods on a fiduciary basis as the Company's bailee;
  - (b) store the Goods (at no cost to the Company) separately from all other goods of the Buyer or any third party in such a way that they remain readily identifiable as the Company's property;
  - (c) not destroy, deface or obscure any identifying mark or packaging on or relating to the Goods; and
  - (d) maintain the Goods in satisfactory condition and keep them insured on the Company's behalf for their full price against all risks to the reasonable satisfaction of the Company. On request the Buyer shall produce the policy of insurance to the Company.
- 8.4 The Buyer may resell the Goods before ownership has passed to it solely on the following conditions:
- (a) any sale shall be effected in the ordinary course of the Buyer's business at full market value; and
  - (b) any such sale shall be a sale of the Company's property on the Buyer's own behalf and the Buyer shall deal as principal when making such a sale.
- 8.5 The Buyer's right to possession of the Goods shall terminate immediately if:
- (a) the Buyer has a bankruptcy order made against him or makes an arrangement or composition with his creditors, or otherwise takes the benefit of any statutory provision for the time being in force for the relief of insolvent debtors, or (being a body corporate) convenes a meeting of creditors (whether formal or informal), or enters into liquidation (whether voluntary or compulsory) except a solvent voluntary liquidation for the purpose only of reconstruction or amalgamation, or has a receiver and/or manager, administrator or administrative receiver appointed of its undertaking or any part thereof, or documents are filed with the court for the appointment of an administrator of the Buyer or notice of intention to appoint an administrator is given by the Buyer or its directors or by a qualifying floating charge holder (as defined in paragraph 14 of Schedule B1 to the Insolvency Act 1986), or a resolution is passed or a petition presented to any court for the winding-up of the Buyer or for the granting of an administration order in respect of the Buyer, or any proceedings are commenced relating to the insolvency or possible insolvency of the Buyer; or
  - (b) the Buyer suffers or allows any execution, whether legal or equitable, to be levied on his/its property or obtained against him/it, or fails to observe or perform any of his/its obligations under the Contract or any other contract between the Company and the Buyer, or is unable to pay its debts within the meaning of section 123 of the Insolvency Act 1986 or the Buyer ceases to trade; or
  - (c) the Buyer encumbers or in any way charges any of the Goods.
- 8.6 The Company shall be entitled to recover payment for the Goods notwithstanding that ownership of any of the Goods has not passed from the Company.
- 8.7 The Buyer grants the Company, its agents and employees an irrevocable licence at any time to enter any premises where the Goods are or may be stored in order to inspect them, or, where the Buyer's right to possession has terminated, to recover them.
- 8.8 Where the Company is unable to determine whether any Goods are the goods in respect of which the Buyer's right to possession has terminated, the Buyer shall be deemed to have sold all goods of the kind sold by the Company to the Buyer in the order in which they were invoiced to the Buyer.
- 8.9 On termination of the Contract, howsoever caused, the Company's (but not the Buyer's) rights contained in this condition 8 shall remain in effect.
- 9. PRICE**
- 9.1 Unless otherwise agreed by the Company in writing, the price for the Goods and/or Services shall be the price set out in the Company's price list published on the date of delivery or deemed delivery.
- 9.2 The price for the Goods and/or Services shall be exclusive of any value added tax.
- 9.3 All costs or charges in relation to carriage and insurance during transit shall be payable by the Buyer in addition to the price of the Goods when it is due to pay for the Goods where the price of the Goods in any Contract is less than £350 before value-added tax, and in all other cases such costs or charges shall be borne by the Company.
- 9.4 For shipments outside UK mainland, i.e. Highlands, Channel Islands, the Company reserves the right to charge a delivery supplement.
- 10. PAYMENT**
- 10.1 Subject to condition 10.4 payment of the price for the Goods and/or services is due 30 days from the date of invoice unless otherwise agreed.
- 10.2 Time for payment shall be of the essence.
- 10.3 No payment shall be deemed to have been received until the Company has received cleared funds.
- 10.4 All payments payable to the Company under the Contract shall become due immediately on its termination despite any other provision.
- 10.5 The Buyer shall make all payments due under the Contract in full without any deduction whether by way of set-off, counterclaim, discount, abatement or otherwise unless the Buyer has a valid court order requiring an amount equal to such deduction to be paid by the Company to the Buyer.
- 10.6 If the Buyer fails to pay the Company any sum due pursuant to the Contract, the Buyer shall be liable to pay interest to the Company on such sum from the due date for payment at the annual rate of 1.5% per month, accruing on a daily basis until payment is made, whether before or after any judgment.
- 11. QUALITY**
- 11.1 The Company warrants that (subject to the other provisions of these conditions):
- (a) upon delivery, and for a period of five years from the date of delivery the Goods shall
    - (i) be of satisfactory quality within the meaning of the Sale of Goods Act 1979;
    - (ii) be reasonably fit for purpose; and
  - (b) the Services shall be performed with reasonable skill and care.
  - (c) This warranty applies to hardware only. Fabric is subject to suppliers' guarantees.
- 11.2 The Company shall not be liable for a breach of any of the warranties in condition 11.1 unless:
- (a) the Buyer gives written notice of the defect to the Company, and, if the defect is as a result of damage in transit to the carrier, within 7 days of the time when the Buyer discovers or ought to have discovered the defect;
  - (b) where the contract is for supply only of Goods the Company is given a reasonable opportunity after receiving the notice of examining the

- Goods and the Buyer (if asked to do so by the Company) returns such Goods to the Company's place of business at the Company's cost for the examination to take place there; and
- (c) where the Contract is for supply and installation of Goods the Company is given a reasonable opportunity after receiving notice of examining the Goods and their installation on site.
- 11.3 The Company shall not be liable for a breach of any of the warranties in condition 11.1 if:
- (a) the Buyer makes any further use of such Goods after giving such notice; or
- (b) the defect arises because the Buyer failed to follow the Company's oral or written instructions as to the storage, installation, commissioning, use or maintenance of the Goods or (if there are none) good trade practice; or
- (c) the Buyer alters or repairs such Goods without the written consent of the Company.
- 11.4 Subject to condition 11.2 and condition 11.3, if any of the Goods and/or Services do not conform with any of the warranties in condition 11.1 the Company shall
- (a) if the Contract is for supply only of Goods, at its option repair or replace such Goods (or the defective part) or refund the price of such Goods at the pro rata Contract rate provided that, if the Company so requests, the Buyer shall, at the Company's expense, return the Goods or the part of such Goods which is defective to the Company;
- (b) if the Contract includes installation of Goods by the Company, the Services shall be reperformed by the Company on site until such Services are in conformity or at the Company's option it may pay for the Services to be performed again.
- 11.5 If the Company complies with condition 11.4 it shall have no further liability for a breach of any of the warranties in condition 11.1 in respect of such Goods and/or Services.
- 11.6 Any Goods replaced shall belong to the Company and any repaired or replacement Goods shall be guaranteed on these terms for the unexpired portion of the five year period.
- 11.7 The Buyer is responsible for ensuring the suitability of and absence from manufacturing flaws in any fabric supplied by the Buyer and for marking any such flaws. The Company is not responsible for the performance of any fabric supplied by the Buyer, including (without limitation) its adhesive capabilities when attaching bond cloth, shrinkage, matching of patterns and manufacture into roller blinds. The Buyer is responsible for all fabric and labour costs of remedying fabric flaws discovered by the Company in the course of manufacturing the Goods.
- 12. LIMITATION OF LIABILITY**
- 12.1 Subject to condition 4, condition 6 and condition 11, the following provisions set out the entire financial liability of the Company (including any liability for the acts or omissions of its employees, agents and sub-contractors) to the Buyer in respect of:
- (a) any breach of these conditions;
- (b) any use made or resale by the Buyer of any of the Goods, or of any product incorporating any of the Goods; and
- (c) any representation, statement or tortious act or omission including negligence arising under or in connection with the Contract.
- 12.2 All warranties, conditions and other terms implied by statute or common law (save for the conditions implied by section 12 of the Sale of Goods Act 1979) are, to the fullest extent permitted by law, excluded from the Contract.
- 12.3 Nothing in these conditions excludes or limits the liability of the Company:
- (a) for death or personal injury caused by the Company's negligence; or
- (b) under section 2(3), Consumer Protection Act 1987; or
- (c) for any matter which it would be illegal for the Company to exclude or attempt to exclude its liability; or
- (d) for fraud or fraudulent misrepresentation.
- 12.4 Subject to condition 12.2 and condition 12.3:
- (a) the Company's total liability in contract, tort (including negligence or breach of statutory duty), misrepresentation, restitution or otherwise, arising in connection with the performance or contemplated performance of the Contract shall be limited to the Contract price; and
- (b) the Company shall not be liable to the Buyer for any pure economic loss, loss of profit, loss of business, depletion of goodwill or otherwise,
- in each case whether direct, indirect or consequential, or any claims for consequential compensation whatsoever (howsoever caused) which arise out of or in connection with the Contract.
- 13. ASSIGNMENT**
- 13.1 The Company may assign the Contract or any part of it to any person, firm or company.
- 13.2 The Buyer shall not be entitled to assign the Contract or any part of it without the prior written consent of the Company.
- 14. FORCE MAJEURE**
- The Company reserves the right to defer the date of delivery or to cancel the Contract or reduce the volume of the Goods ordered by the Buyer (without liability to the Buyer) if it is prevented from or delayed in the carrying on of its business due to circumstances beyond the reasonable control of the Company including, without limitation, acts of God, governmental actions, war or national emergency, acts of terrorism, protests, riot, civil commotion, fire, explosion, flood, epidemic, lock-outs, strikes or other labour disputes (whether or not relating to either party's workforce), or restraints or delays affecting carriers or inability or delay in obtaining supplies of adequate or suitable materials, provided that, if the event in question continues for a continuous period in excess of 60 days, the Buyer shall be entitled to give notice in writing to the Company to terminate the Contract.
- 15. GENERAL**
- 15.1 Each right or remedy of the Company under the Contract is without prejudice to any other right or remedy of the Company whether under the Contract or not.
- 15.2 If any provision of the Contract is found by any court, tribunal or administrative body of competent jurisdiction to be wholly or partly illegal, invalid, void, voidable, unenforceable or unreasonable it shall to the extent of such illegality, invalidity, voidness, voidability, unenforceability or unreasonableness be deemed severable and the remaining provisions of the Contract and the remainder of such provision shall continue in full force and effect.
- 15.3 Failure or delay by the Company in enforcing or partially enforcing any provision of the Contract shall not be construed as a waiver of any of its rights under the Contract.
- 15.4 Any waiver by the Company of any breach of, or any default under, any provision of the Contract by the Buyer shall not be deemed a waiver of any subsequent breach or default and shall in no way affect the other terms of the Contract.
- 15.5 The parties to the Contract do not intend that any term of the Contract shall be enforceable by virtue of the Contracts (Rights of Third Parties) Act 1999 by any person that is not a party to it.
- 15.6 The formation, existence, construction, performance, validity and all aspects of the Contract shall be governed by English law and the parties submit to the exclusive jurisdiction of the English courts.
- 16. COMMUNICATIONS**
- 16.1 All communications between the parties about the Contract shall be in writing and delivered by hand or sent by pre-paid first class post or sent by e-mail:
- (a) (in case of communications to the Company) to its registered office or such changed address as shall be notified to the Buyer by the Company; or
- (b) (in the case of the communications to the Buyer) to the registered office of the addressee (if it is a company) or (in any other case) to any address of the Buyer set out in any document which forms part of the Contract or such other address as shall be notified to the Company by the Buyer.
- 16.2 Communications shall be deemed to have been received:
- (a) if sent by pre-paid first class post, two days (excluding Saturdays, Sundays and bank and public holidays) after posting (exclusive of the day of posting); or
- (b) if delivered by hand, on the day of delivery; or
- (c) if sent by e-mail on a working day prior to 4.00 pm, at the time of sending and otherwise on the next working day.
- 16.3 Communications addressed to the Company shall be marked for the attention of the Sales Director.









## *The Architects of Silence*

*Silent Gliss is the leading global supplier of premium interior window treatments. Since 1952 we have been tirelessly committed to the development of the worlds' smoothest, quietest systems using state of the art technology.*

*Driven by customer needs, Silent Gliss offers functional and durable products. Expert technical advice coupled with installation and support services complete the offer. Silent Gliss stands for innovative, sustainable, tailor made solutions, exceptional design and first-class quality.*

**Silent Gliss Ltd.**  
Pyramid Business Park  
Poorhole Lane, Broadstairs  
Kent CT10 2PT  
United Kingdom  
T +44 1843 863571  
info@silentgliss.co.uk

[silentgliss.co.uk](http://silentgliss.co.uk)